





TM6100 barn doors in Select Alder with Espresso stain and White Lami glass

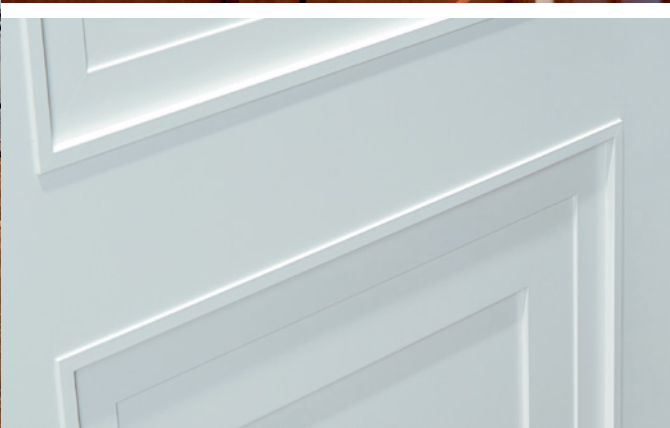

Table of Contents

TruStile® Overview	2
Authentic Designs®	11
Quality and Construction	62
Material Options	68
Design Options	80
Commercial Applications	90
Door Collections	101



T H E D E F I N I T I O N O F L U X U R Y

Premium Architectural Doors

There was a time when doors were appreciated for their architectural value, gracing the openings of homes and embodying the principles of their design periods.

At TruStile, we miss those days. We are committed to partnering with architects, home builders and homeowners, to revive the rich tradition of building high-quality, architecturally-correct doors with a range of customization options to fit your preferences and your home's unique character.

TM6100 in White Oak with Shagreen Grey Oyster leather and One Step (OS) sticking

**HANDCRAFTED
AND
CUSTOM MADE**

Our team of craftsmen, designers and machinists ensure only the best doors leave our shop.

Visualize the TruStile Difference

BEFORE

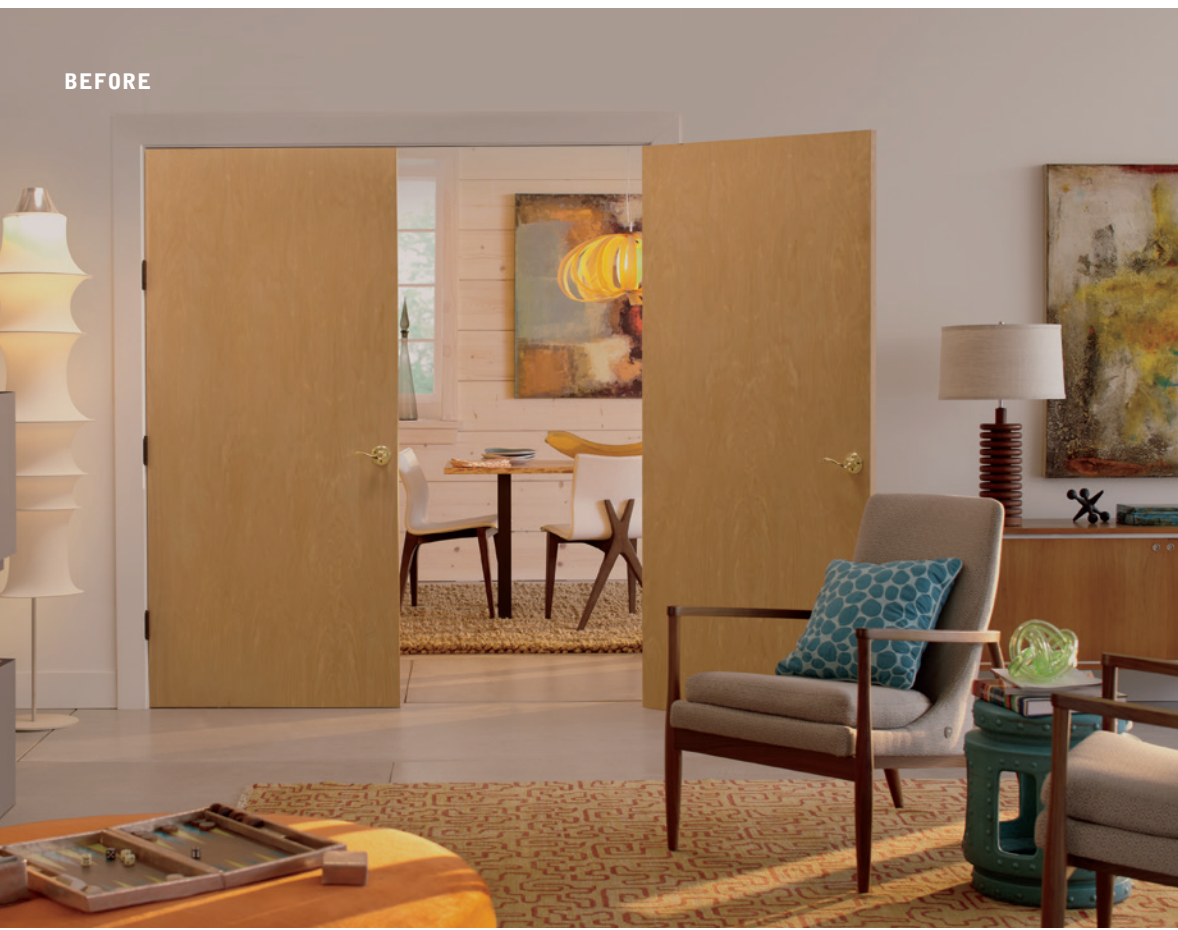

All too often, doors are an overlooked design element — even in high-end custom homes that include an otherwise impressive selection of amenities and upgrades.

Other manufacturers have focused on value-engineering doors, thus diminishing their structural and design integrity. However, the visual impact of high quality architectural doors is dramatic.



AFTER

TM13000 in Cherry with Kerf Cut reveal

The Architecturally Correct Door

TruStile doors are made with authentic stile and rail construction. We wouldn't think of routing or stamping a door. Each TruStile door is made to order with perfectly proportioned components, created individually to ensure that every door is architecturally correct, regardless of size.

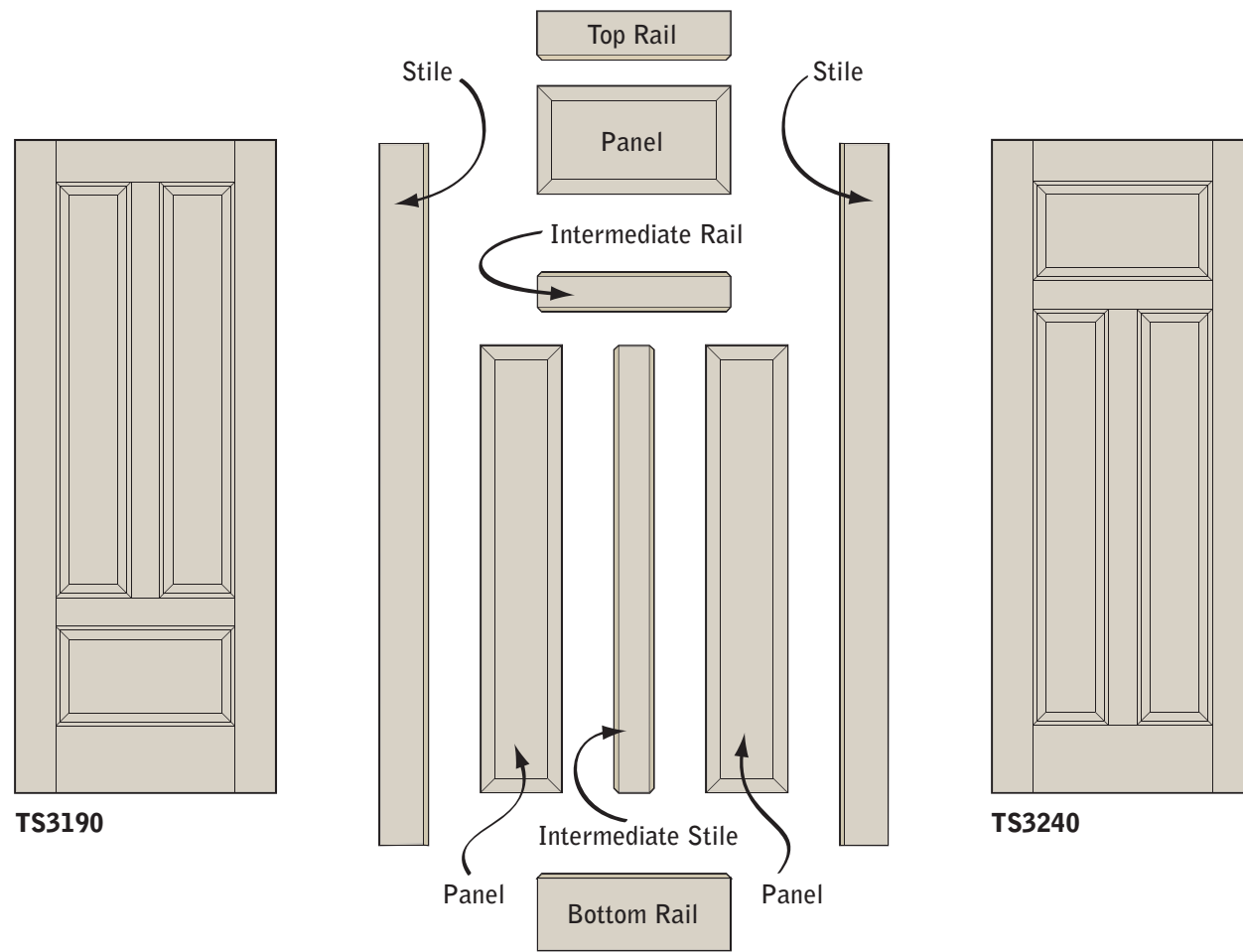

All doors are not created equal.

The figure illustrates the timeless advantage of TruStile's authentic stile and rail construction. All door components can be customized and combined to create the style you desire, while the construction method gives each door crisp, architecturally-correct lines.



TS3240 in Cherry with Square Stick (SS) sticking and Flat (C) panel

6 Steps to Designing Your Perfect Door

TruStile Selection Guide

To guide your style choices, consider the recommendations in the Authentic Designs section on page 11.



1

DOOR STYLE

Choose from over 400 door styles to match your home's architecture.



2

WOOD SPECIES

Select MDF for painted applications or choose from 20 wood species.

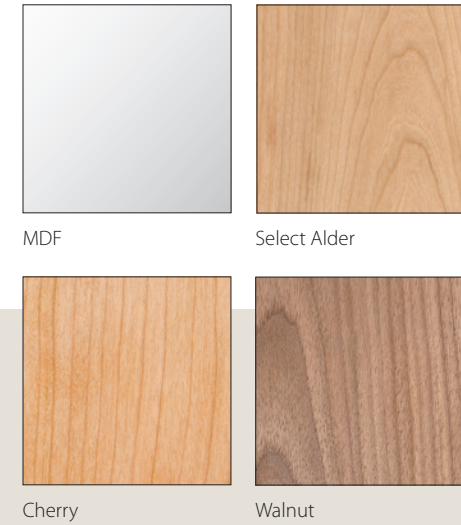

3

PROFILE OPTIONS

Refine your design with the widest selection of profile options to match your desired style.



Roman Ogee (OG) moulding with Raised (A) panel



Square Stick (SS) sticking with V-groove panel



Bolection (BM) moulding with Senior Raised (E) panel

4

MATERIAL INSERTS

Consider exchanging a panel for a unique material insert — glass, resin, leather or metal.

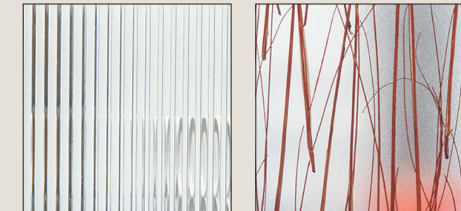

Glass

Resin

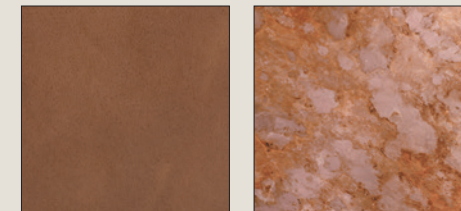

Leather

Metal

5

DESIGN OPTIONS

Further customize your doors with design options such as Built-in mirrors or Common Arch Pairs. See page 80 for more ideas.

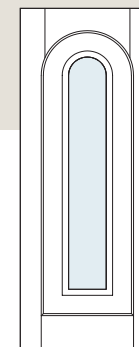

6

CUSTOM DIMENSIONS

Further customize your door design by changing the stile and rail dimensions.





Authentic Designs®

Where do you begin to choose the right door design for your home? TruStile's Authentic Designs makes the selection process fun and easy.

With a range of materials and options for 12 popular architectural styles, TruStile provides the widest range of on the market today.

Read on and be inspired with just a few of our tantalizing options for distinctive, remarkable doors.





ART DECO

An eclectic style decorated with geometric shapes and accents of metal and glass.



TMB6120 in MDF with Bevel profile

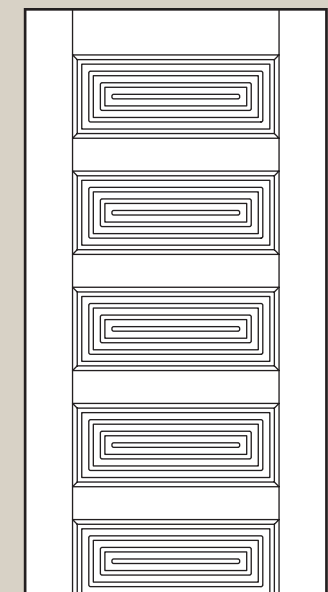

- The Art Deco design style began after WWI and flourished in the 1930s and 1940s, waning after WWII.
- While there are no distinct guiding design principles of Art Deco, there are stylistic elements connected by common themes: the decorative, the commercial, the fashionable and the symbolic.
- The TruStile Art Deco door styles combine modern European design ideas introduced in France with the romance of 1930s Hollywood.

ART DECO
INTERNATIONAL STYLE
ART MODERNE
ART NOUVEAU

Find the ideal expression of the streamlined and sophisticated art deco style right here.

PROFILE SUGGESTIONS



Square Stick (SS) sticking with Flat (C) panel



Bolection (BM) Moulding with Raised (A) panel



Half-round Tambour profile

WOOD SPECIES SUGGESTIONS



MDF/Paint Grade

Mahogany



White Maple

Wenge

INSERT SUGGESTIONS

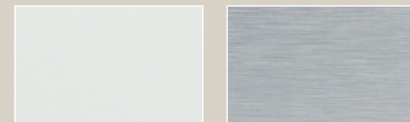

White Lami glass

Brushed Aluminum metal

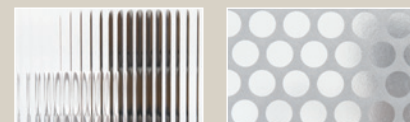

Reeded glass

Cirque resin

RECOMMENDED DOOR STYLES

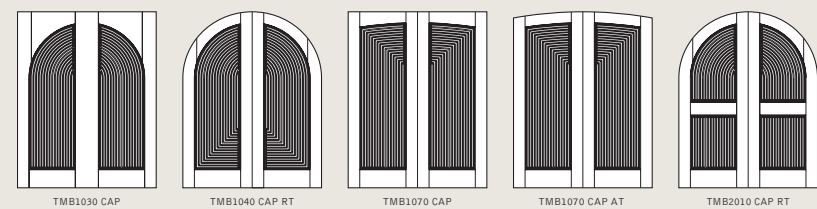
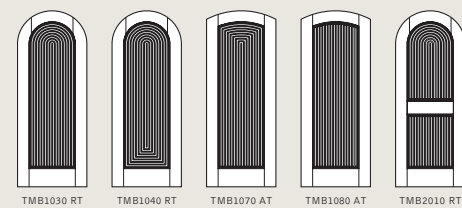
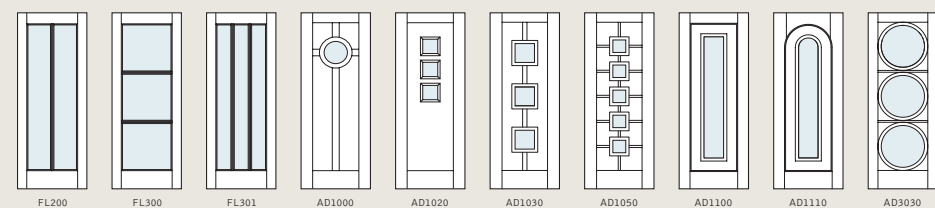
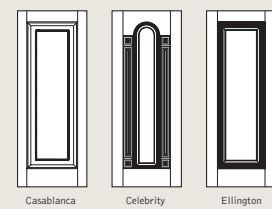
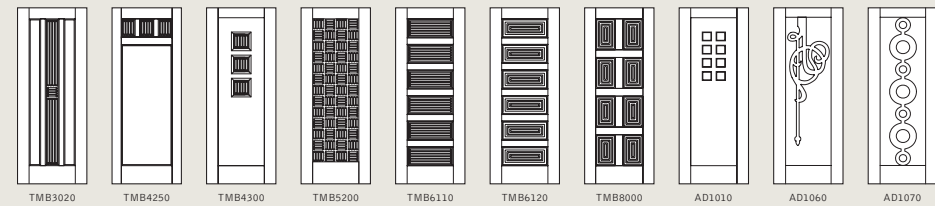
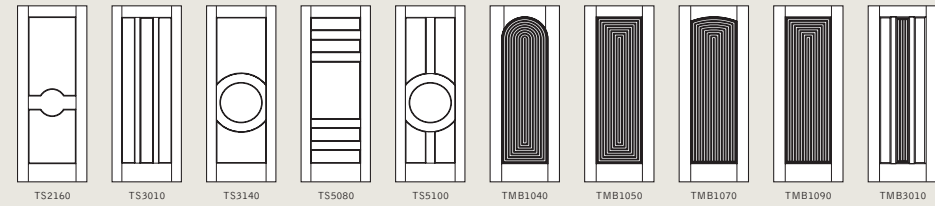

AD1070 in MDF



TS7010 in MDF with Roman Ogee (OG) sticking and Raised (A) panel

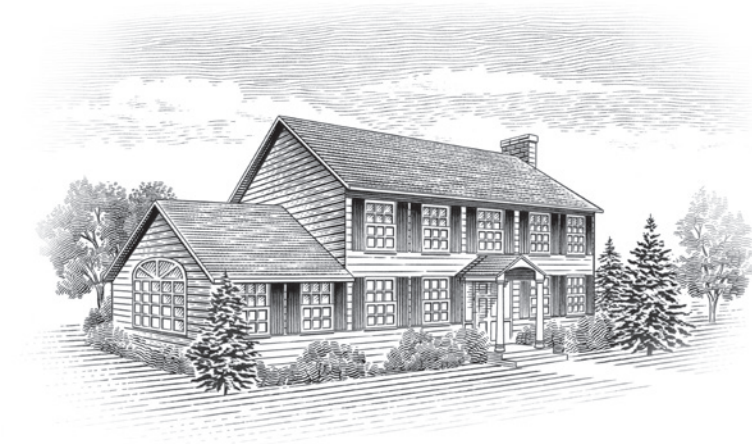

COLONIAL

An authentically American style characterized by stately, historic design features.

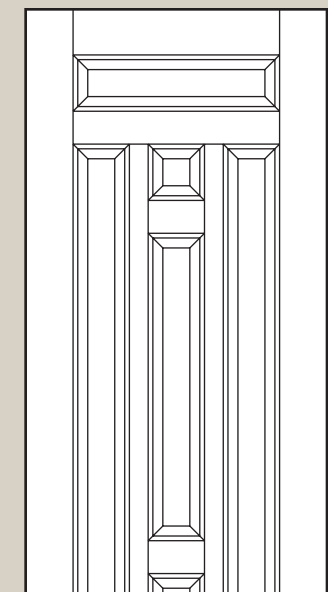

- A variety of architectural styles developed throughout the 18th and 19th centuries as the English, Dutch, Germans and French settled in America.
- Characterized by symmetry and balance, formal surface design and ornamentation with special attention to doors and windows.
- Authentic TruStile doors from the Colonial collection provide classic grace and elegance along with an early American sensibility.

COLONIAL
 GEORGIAN
 FEDERAL
 GREEK REVIVAL

Find the distinct, formal design for your colonial home that emphasizes symmetry and balance right here.

PROFILE SUGGESTIONS



Roman Ogee (OG) sticking with Scoop (B) panel



Cove & Bead (CB) sticking with Scoop (B) panel



Quarter Bead (QB) sticking with Raised (A) panel

WOOD SPECIES SUGGESTIONS



MDF/Paint Grade

Cherry



Mahogany

Walnut

INSERT SUGGESTIONS



Bevel glass

Seedy Wash glass



Oak leather

Pampas leather

RECOMMENDED DOOR STYLES

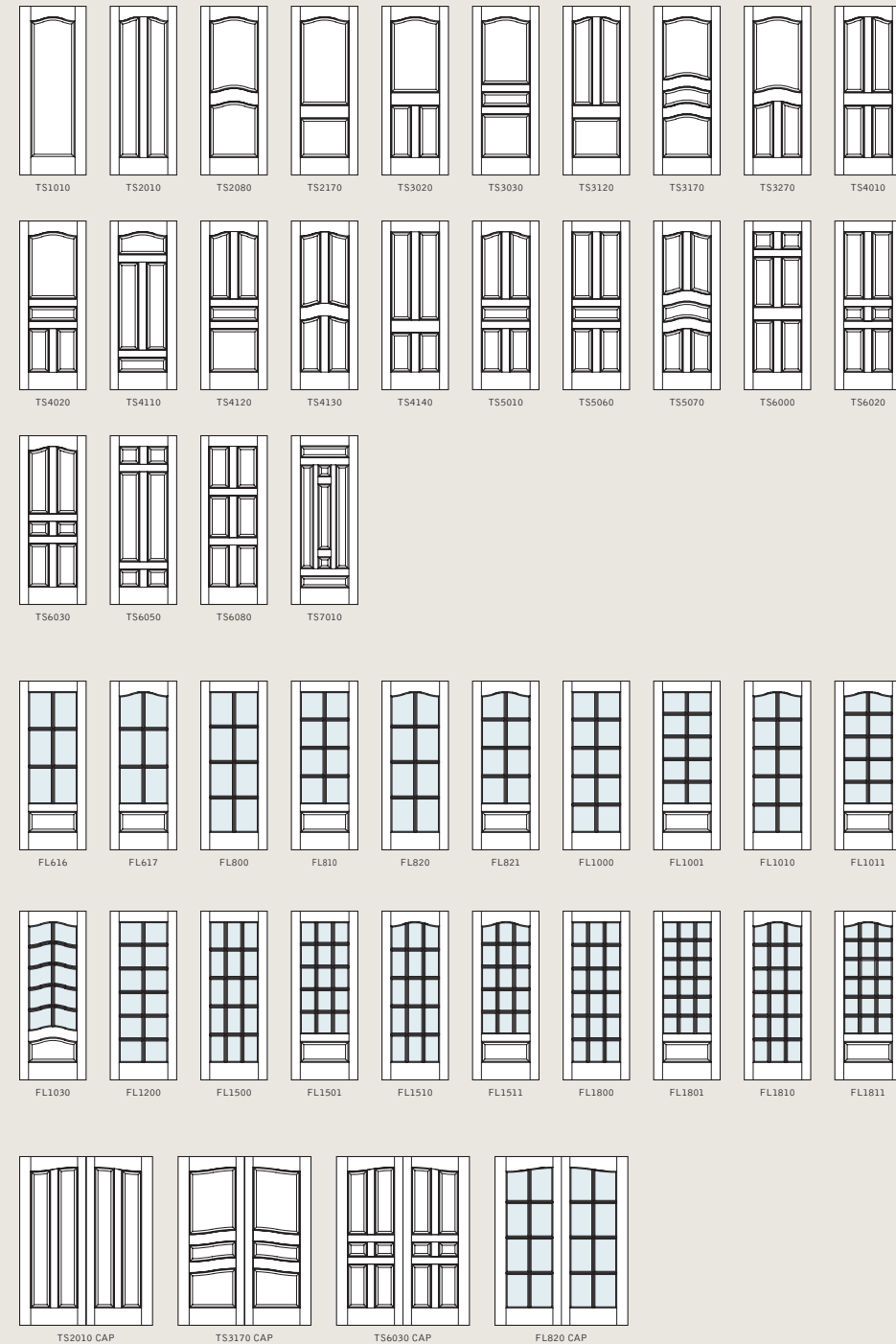

TS4010 in Walnut with Roman Ogee (OG) sticking and Scoop (B) panel



AD1030 in LVL with Square Stick (SS) sticking, Flat (C) panel and Gingko Thatch resin

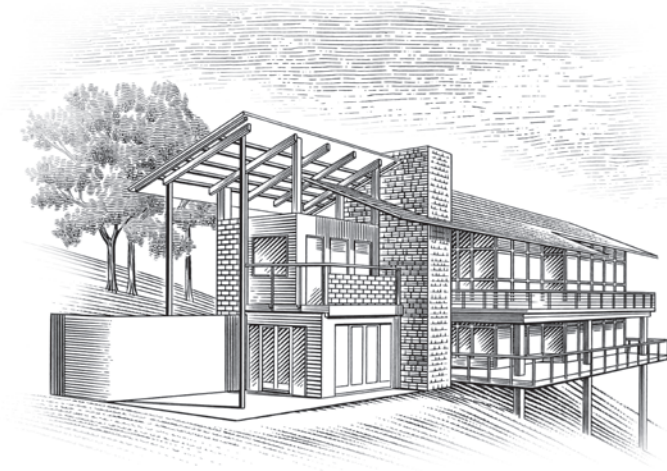

CONTEMPORARY

A forward-looking style that is uniquely yours.

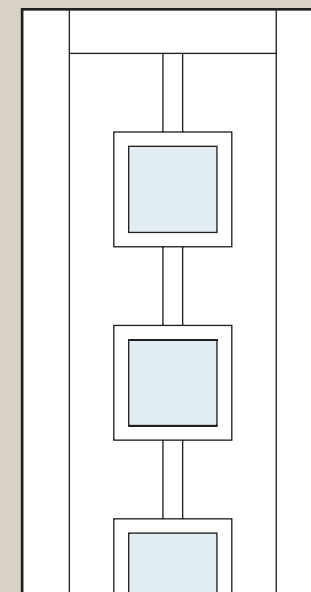

- Contemporary architecture is the current building style of today.
- Characteristics of contemporary homes are unique or odd shaped frames, open floor plans, oversized windows, connected indoor and outdoor spaces and warm interiors.
- TruStile's Contemporary series is an eclectic collection that borrows ideas from different eras. Popular elements are clean lines and the use of natural, sustainable materials.

CONTEMPORARY
INDUSTRIAL
TODAY'S STYLE

Find the ideal expression of what
contemporary design means to you.

PROFILE SUGGESTIONS



1/8" Radius reveal



Roman Ogee (OG) sticking
with Raised (A) panel

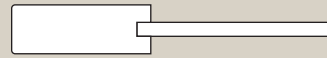

Square Stick (SS) sticking
with Flat (C) panel

WOOD SPECIES SUGGESTIONS



MDF/Paint Grade

Walnut



LVL

Bamboo

INSERT SUGGESTIONS



Brushed Brass metal

Ginkgo Thatch resin

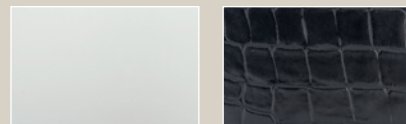

White Lami glass

Croc Black leather

RECOMMENDED DOOR STYLES



TM9000 in MDF with
1/4" Kerf Cut reveal

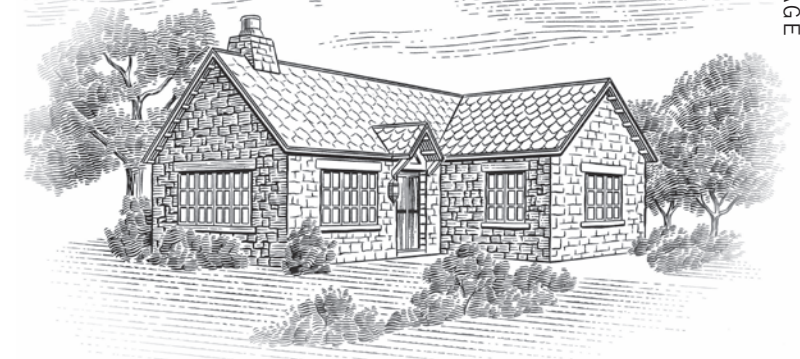

COTTAGE

A comfortable style that reflects architectural simplicity.



PL404 in MDF with Wave glass, Roman Ogee (OG) sticking and Flat (C) panel

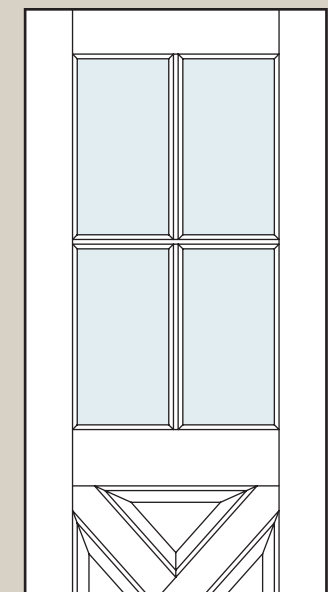

- The American cottage style of architecture was inspired by the English countryside and features a cozy, almost storybook character.
- Characteristics include steep roofs, arched doors and casement windows. A variety of natural materials can be used ranging from wood siding, stone, shingles and copper.
- TruStile's Cottage series represents historically accurate door styles in both panel and glass configurations, as well as updated interpretations of the historic designs.

Find the natural expression of the simple
and charming cottage style right here.

PROFILE SUGGESTIONS



Quarter Bead (QB) sticking
with Flat (C) panel



Quarter Round (QR) sticking
with Raised (A) panel

WOOD SPECIES SUGGESTIONS

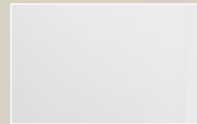

MDF/Paint Grade

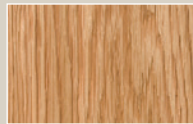

White Oak Wirebrush



Select Alder



Douglas Fir

INSERT SUGGESTIONS



Arctic glass



Clear Leaf glass



Wave glass



Venetian Vertical metal

RECOMMENDED DOOR STYLES

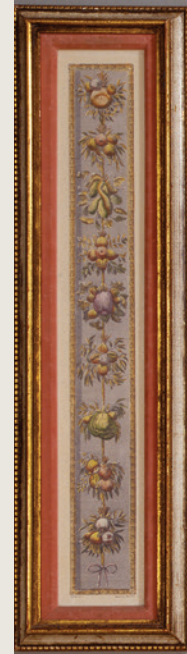

TS3100 in MDF with Quarter Bead (QB) sticking and Flat (C) panel



TS5120 in Cherry with Wenge insert, Square Stick (SS) sticking and Flat (C) panel



CRAFTSMAN

CRAFTSMAN

A simple style focused on natural materials and an attention to period details.

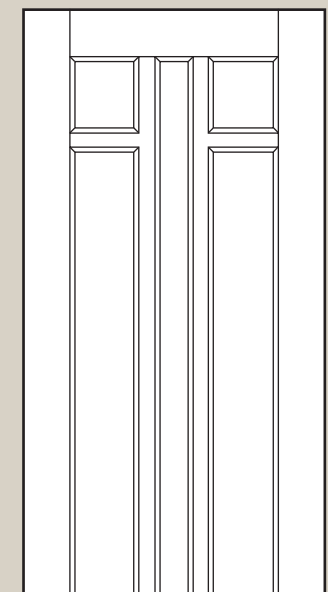

- The American Craftsman style emerged from the English Arts & Crafts movement of the late 1800s and was a reaction to the overly decorative Victorian era.
- Emphasizes simplicity of form, originality and local natural materials.
- Simplicity and quality workmanship define the TruStile Craftsman door collection.

CRAFTSMAN
ARTS & CRAFTS
BUNGALOW
PRAIRIE SCHOOL

Find hand-crafted doors that will add an authentic touch to your modern-day bungalow right here.

PROFILE SUGGESTIONS



Square Stick (SS) sticking with Flat (C) panel



One Step (OS) sticking with Flat (C) panel

WOOD SPECIES SUGGESTIONS

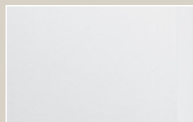

MDF/Paint Grade



Cherry



White Oak Wirebrush



Douglas Fir

INSERT SUGGESTIONS

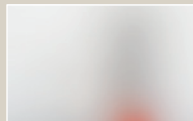

Frosted glass



Seedy Wash glass



Glue Chip glass

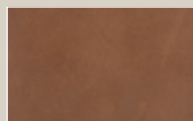

Pampas leather

RECOMMENDED DOOR STYLES

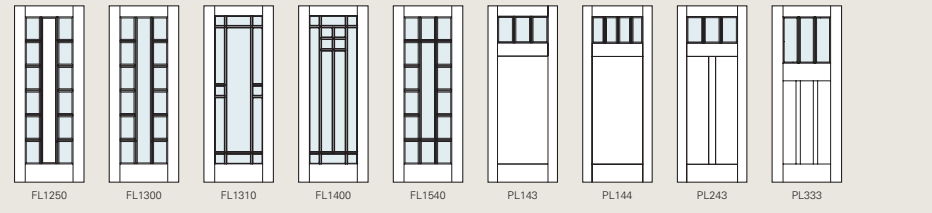
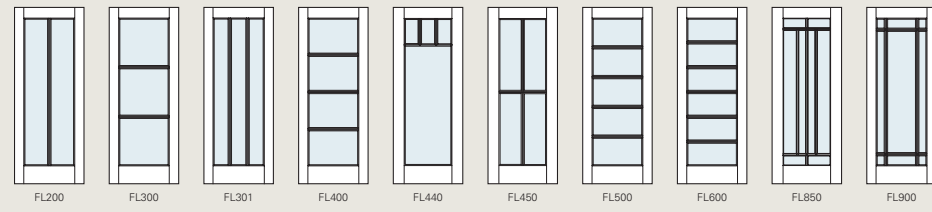
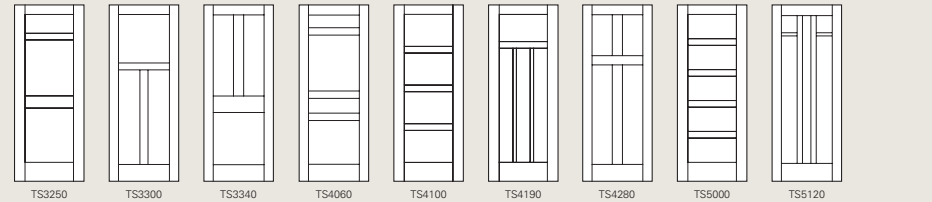
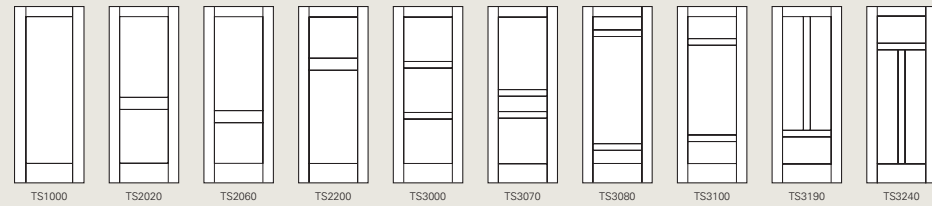

TS3300 in MDF with Square Stick sticking and Flat (C) panel



Arch-top modified TS3040 in MDF with Roman Ogee (OG) sticking and Senior Raised (E) panel



FRENCH COUNTRY

FRENCH COUNTRY

An eclectic yet decidedly French style that evokes classic European appeal.

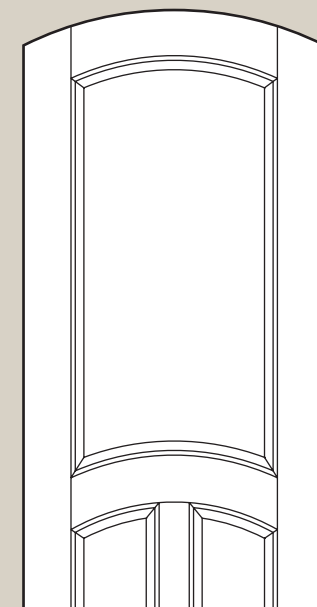

- From elaborate Ecole-des-Beaux-Arts inspired Chateaux to stunning estates in Provence, the French Country style includes decorative detailing, organic floral patterns, distressed woodwork and the use of both subdued and vibrant tones.
- Whether your tastes lean toward the formal Chateau style or the relaxed provincial style, TruStile's French Country series will take your design sensibilities back to the high style of French art and architecture.

FRENCH COUNTRY
BEAUX ARTS
CHATEAU
NEW EUROPEAN

Art and style that is intrinsically French marries casual charm with understated elegance. Find it here.

PROFILE SUGGESTIONS



Low Profile Bolection (LP) moulding with Double Hip (D) panel



Roman Ogee (OG) sticking with Senior Raised (E) panel



Roman Ogee (OG) sticking with Raised (A) panel

WOOD SPECIES SUGGESTIONS

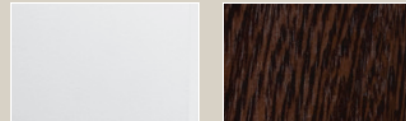

MDF/Paint Grade

Wenge



Hickory

Mahogany

INSERT SUGGESTIONS



Brushed glass

Rain glass



Fossil resin

Ting Ting resin

RECOMMENDED DOOR STYLES

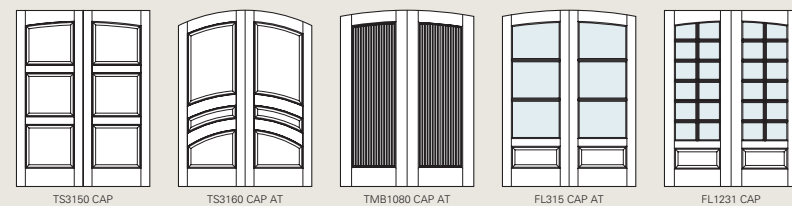
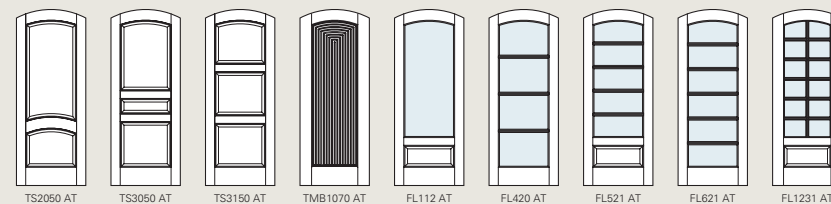
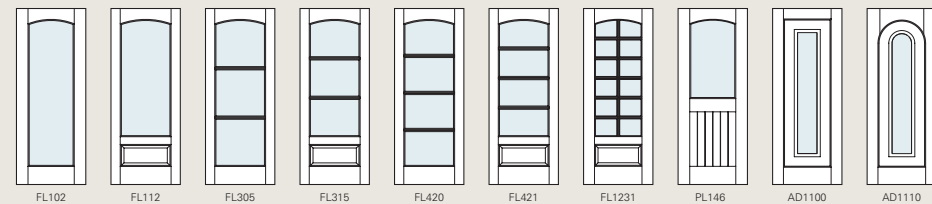
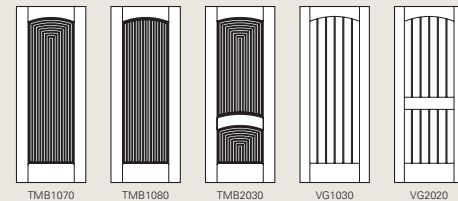

TS2050 in MDF with Low Profile Bolection (LP) moulding and Double Hip (D) panel



Radius-top TS6090 in Knotty Alder with Square Stick (SS) sticking and Raised (A) panel

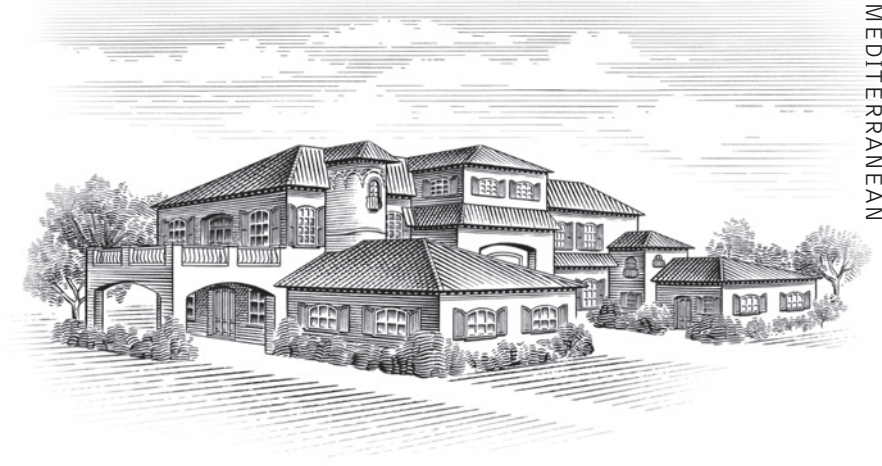

MEDITERRANEAN

An enduring trend in American architecture and interior design that expresses a Tuscan sensibility.

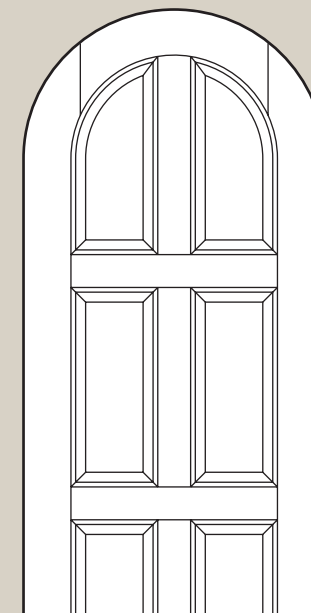

- Inspired by the Italian Renaissance, Mediterranean designs appeared in American architecture between the late 1800s and early 1900s. This movement drew heavily on Italian palaces and seaside or country villas.
- Mediterranean details include arched windows and doorways, recessed entryways, red tiled roofs and stuccoed walls.
- TruStile's Mediterranean collection brings the richness and charm of Italian living to your home.

MEDITERRANEAN
ITALIANATE
TUSCAN

Find the warm aesthetic of Mediterranean style through this simple yet elegant offering right here.

PROFILE SUGGESTIONS



Square Stick (SS) sticking with V-groove panel



Square Stick (SS) sticking with Raised (A) panel



Roman Ogee (OG) sticking with Senior Raised (E) panel

WOOD SPECIES SUGGESTIONS

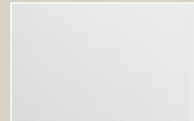

MDF/Paint Grade



Knotty Alder



Select Alder



Douglas Fir Wirebrush

INSERT SUGGESTIONS



Arctic glass



Seedy Wash glass



Patina Canterbury metal

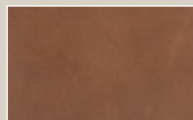

Pampas leather

RECOMMENDED DOOR STYLES

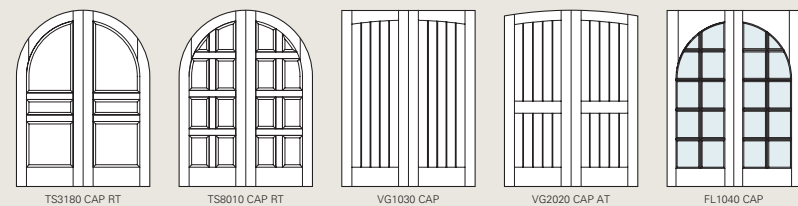
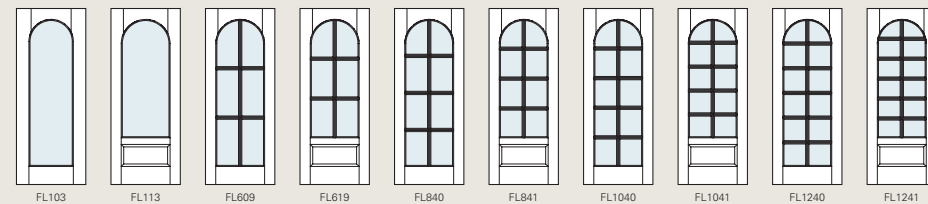
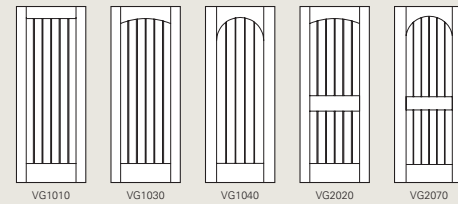
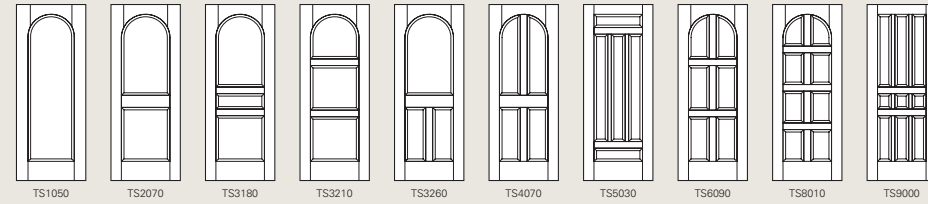

VG1000 plank door in Hickory with wide V-groove and Cappuccino stain



MODERN

Clean strong lines. Bold accents.
Custom design options.



Modified TM6100 in MDF with One Step (OS) sash and Paper Cut resin inserts

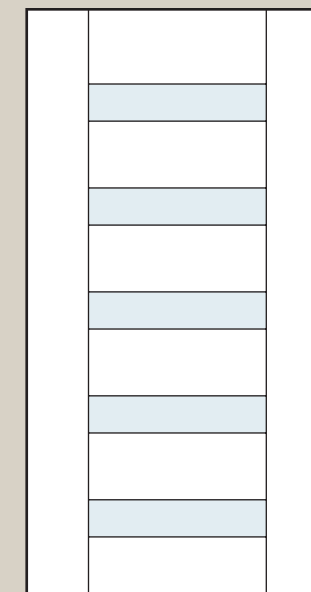

- Early Modern architecture took root in the U.S. in the 1920s and reached its peak in the mid 20th century.
- Characterized by simplification of form, an absence of ornate detail and a belief that "less is more", Modern style has streamlined horizontal lines and uses industrial materials such as concrete, steel and glass.
- TruStile's Modern Door Collection is centered around crisp, stacked rails, clean strong lines, oversized stiles, custom design options and bold accents.

MODERN
MID-CENTURY
USONIAN
GOOGIE

Make a clever design statement before
ever entering the room. Find it here.

PROFILE SUGGESTIONS



1/8" Radius reveal



1/4" Kerf Cut reveal

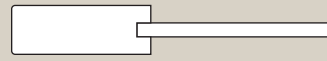

Square Stick (SS) sticking
with Flat (C) panel

WOOD SPECIES SUGGESTIONS



MDF/Paint Grade

LVL



Walnut

Cherry

INSERT SUGGESTIONS

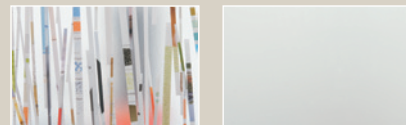

Paper Cut resin

White Lami glass

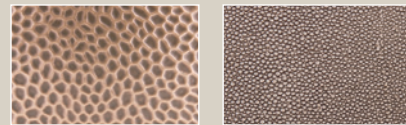

Hammered Reptilian
metal

Shagreen Grey
Oyster leather

RECOMMENDED DOOR STYLES



TM13340 in Walnut with
1/4" kerf cut reveal and
White Lami glass.





VG2010 in Wire-Brushed White Oak with V-groove panels



SPANISH COLONIAL

A warm style that exudes a sophisticated design with ornate touches.

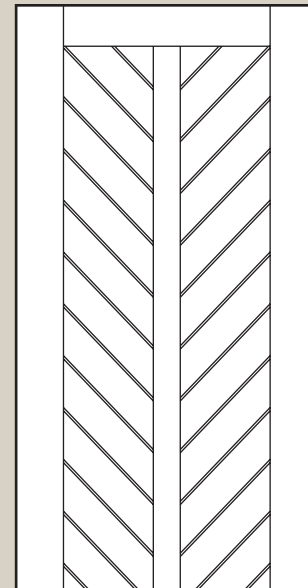

- The Spanish Colonial style of architecture was popular in the early 20th century and was embraced in both Florida and California, as well as the southwestern U.S.
- This style is characterized by smooth stucco walls, low pitched roofs, arched entryways and small porches or balconies.
- TruStile's Spanish Colonial series showcases doors with simple lines associated with today's Mission-inspired architecture as well as decorative Spanish Revival door designs.

SPANISH COLONIAL SOUTHWESTERN MISSION

Find the warm expression of the elegant and refined Spanish Colonial style right here.

PROFILE SUGGESTIONS



One Step (OS) sticking with Flat (C) panel



Square Stick (SS) sticking with V-groove panel



Roman Ogee (OG) with Senior Raised (E) panel

WOOD SPECIES SUGGESTIONS



MDF/Paint Grade

Knotty Alder



Red Oak

White Oak Wirebrush

INSERT SUGGESTIONS

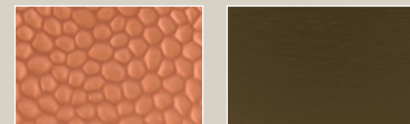

Hammered Cobblestone metal

Brushed Bronze metal



Old Cherry leather

Wave glass

RECOMMENDED DOOR STYLES

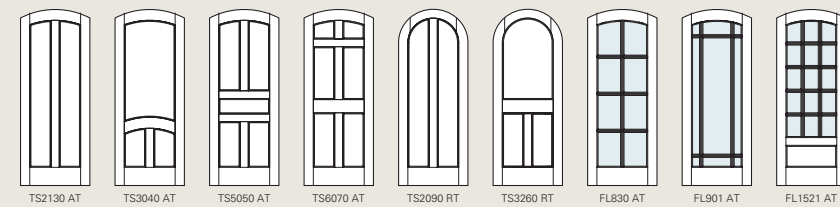
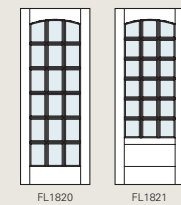
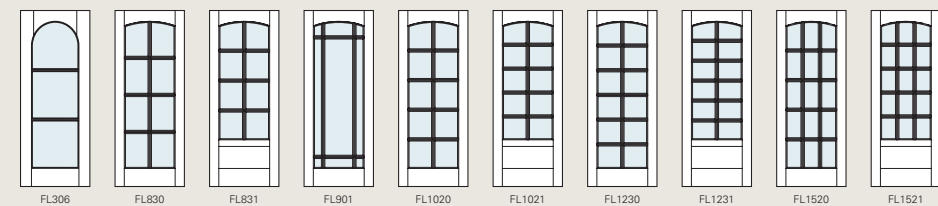
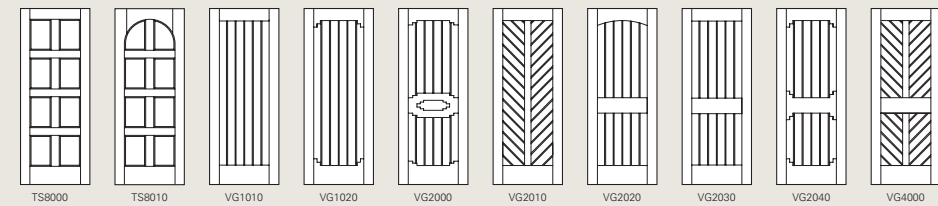
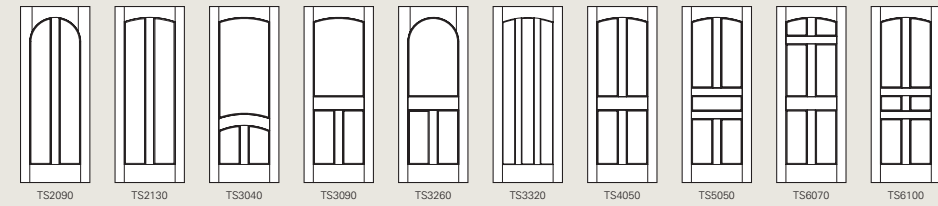

Radius-top TS2090 in Red Oak with One Step (OS) sticking and Flat (C) panel



TS4000 in MDF with custom sticking and Raised (A) panel



TRADITIONAL

Traditional design often reflects the common sense principles of practicality and functionality.

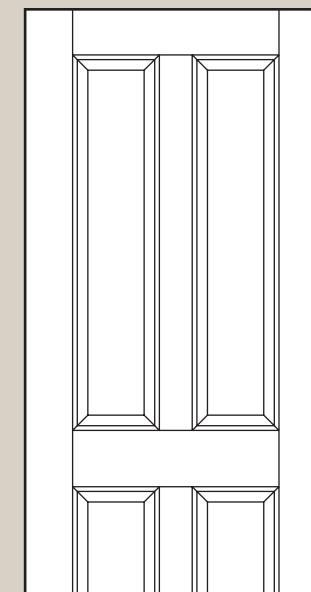

- Broadly defined, Traditional or vernacular architecture is viewed as a conservative way of building homes to retain the style and beauty of a particular community based on the localized design and historic context.
- On the East Coast, this style is most often associated with Cape Cod, Shingle or Americana styles, while in the Western U.S. the American Ranch style is predominant.
- TruStile's Traditional series reflects the classic and historic design ideas of an earlier time and place.

**TRADITIONAL
CAPE COD
FOUR SQUARE
RANCH**

Bring the charm of Americana or the historic character of the New England Cape to your home with any of these doors.

PROFILE SUGGESTIONS



Cove & Bead (CB) sticking with Raised (A) panel



Quarter Bead (QB) sticking with Flat (C) panel



Quarter Round (QR) sticking with Raised (A) panel

WOOD SPECIES SUGGESTIONS



MDF/Paint Grade

Clear Pine



Mahogany

Poplar

INSERT SUGGESTIONS



Bevel glass

Rain glass

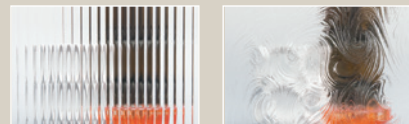

Reeded glass

Whirl glass

RECOMMENDED DOOR STYLES

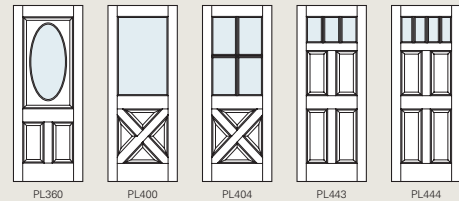
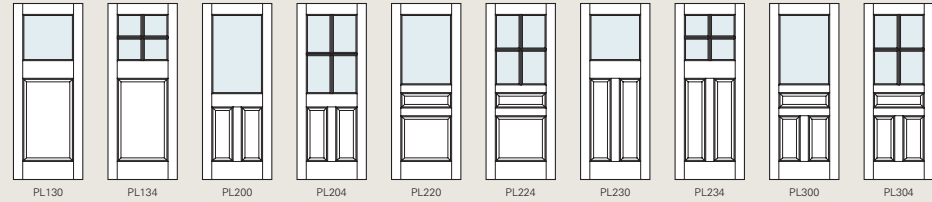
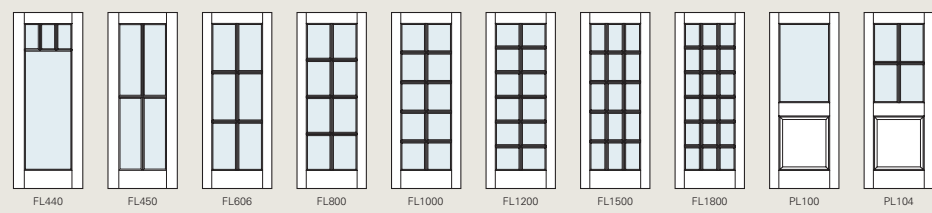
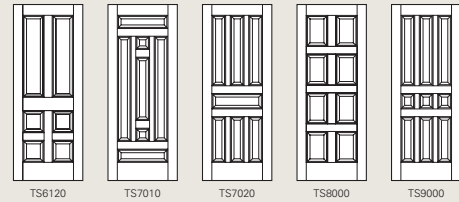
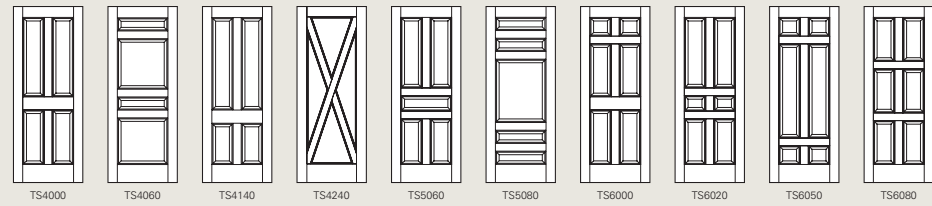

FL800 in MDF with Roman Ogee (OG) sash and Clear glass



AD1110 in Walnut with Square Stick (SS) sticking, Flat (O) panel and Reeded glass insert



TUDOR

Tudor architecture reflects a return to a more conservative and formal aesthetic.

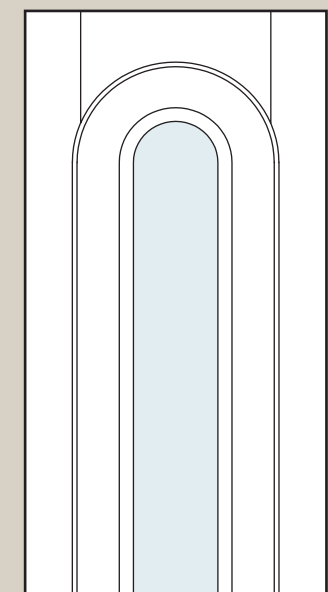

- The Tudor period was a distinct part of the Revivalist period in architectural history.
- The Tudor home features steeply pitched gabled roofs, high chimneys, tall mullioned windows and half-timbering.
- Inspired by English manor homes, the TruStile Tudor series features an assortment of elegant designs and gentle arches.

TUDOR
ENGLISH TUDOR
TUDOR REVIVAL

TruStile's Tudor series will bring a touch of English charm to your home. Find it here.

PROFILE SUGGESTIONS



Cove & Bead (CB) sticking with Double Hip (D) panel



Low Profile Bolection (LP) moulding with Raised (A) panel



Roman Ogee (OG) sticking with Raised (A) panel

WOOD SPECIES SUGGESTIONS



MDF/Paint Grade

Mahogany



Walnut

Select Alder

INSERT SUGGESTIONS



Glue Chip glass

Obscure glass



Old Cherry leather

Pampas leather

RECOMMENDED DOOR STYLES

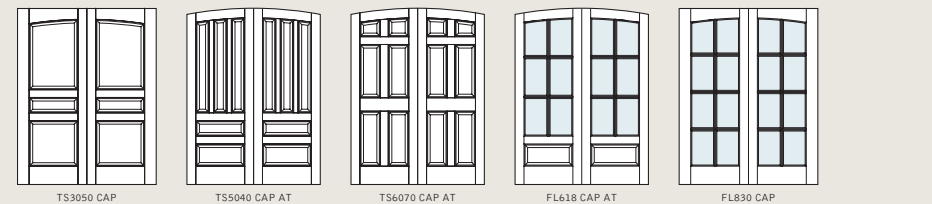
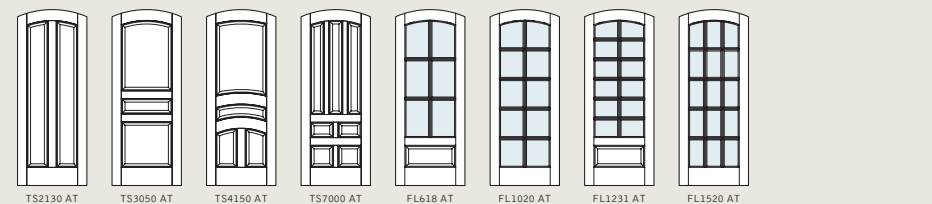
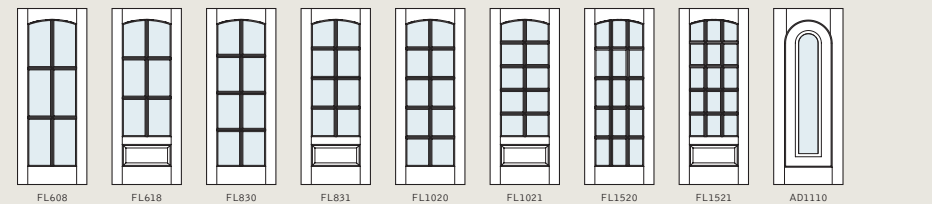
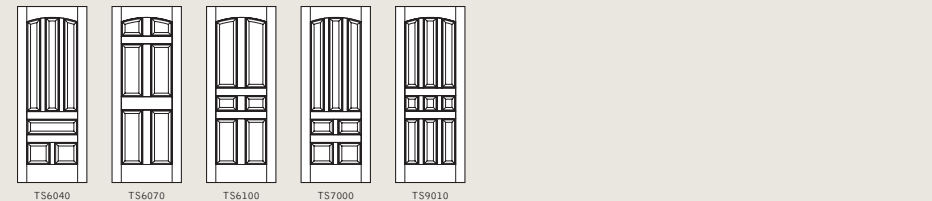

TUDOR

Arch-top TS3050 in MDF with Roman Ogee (OG) sticking and Raised (A) panel



Radius-top modified TS3180 in White Oak with Bolection (BM) moulding and Raised (A) panel



VICTORIAN

Where unconventional ideas took root and elaborate styles came to light.

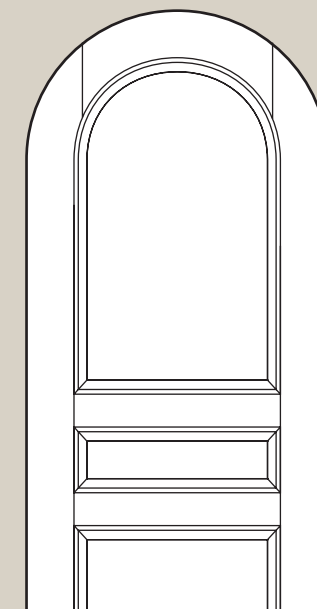

- The Victorian era of architecture reigned from the 1830s until the beginning of the 20th century and was known as a period of romanticism.
- Ornamentation such as gingerbread detailing or Victorian lace is frequently used. Roof lines tend to be accented with hipped gables, towers and dormers.
- The ornate nature of the TruStile Victorian door line effectively reproduces this historic time period within your home.

VICTORIAN
QUEEN ANNE
GOTHIC

Romantic expression and imagination are emphasized in the Victorian style. Find it here.

PROFILE SUGGESTIONS

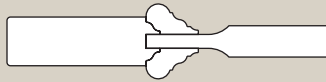

Big Bolection (BB) moulding with Scoop (B) panel

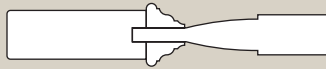

Bolection (BM) moulding with Senior Raised (E) panel

WOOD SPECIES SUGGESTIONS



MDF/Paint Grade

Mahogany



Clear Pine

White Oak

INSERT SUGGESTIONS



Bevel glass

Seedy Wash glass



Croc Black Leather

Old Cherry Leather

RECOMMENDED DOOR STYLES

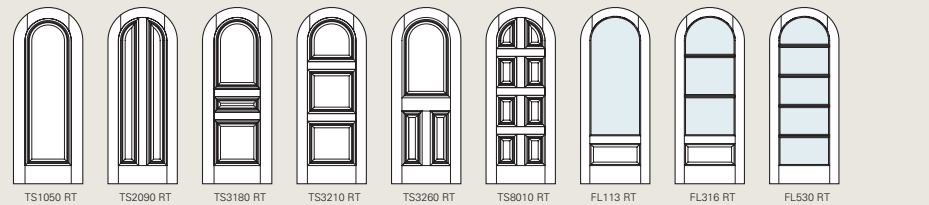
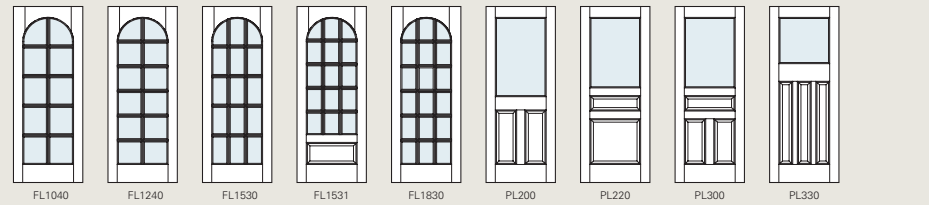
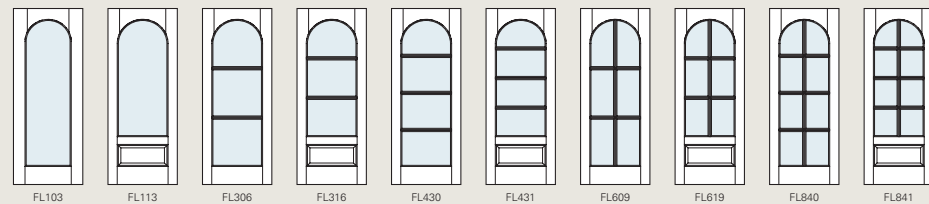
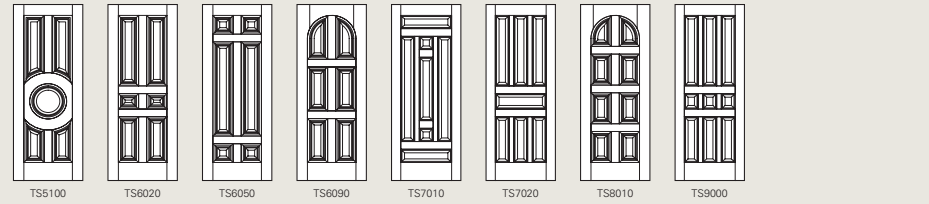
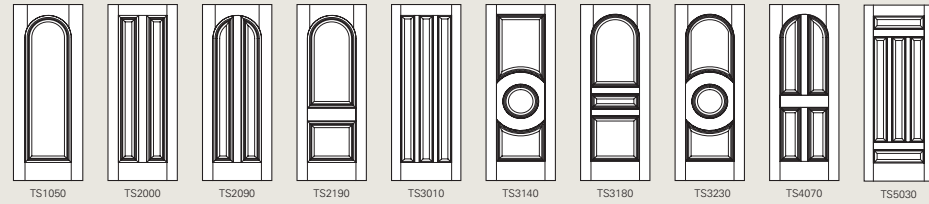

TS4070 Radius top in MDF with Roman Ogee (OG) sticking and Raised (A) panel



TS3000 pocket door in MDF with Narrow Reed glass

Design Options

Like furnishings and décor, doors should complement your home's unique architecture and individual style. TruStile Doors provide you with ultimate flexibility, offering unique design options including accents of metal, glass, resin and leather; common arch pairs and built-in mirrors — just to name a few.

TS3000 in MDF with Custom sticking and Senior Raised (E) panel



Ideal for Painted Applications

TruStile MDF Doors

TruStile MDF Doors provide quality that is unrivaled. Our super-refined MDF material and meticulous construction methods result in a painted door product that is a cut above the rest.

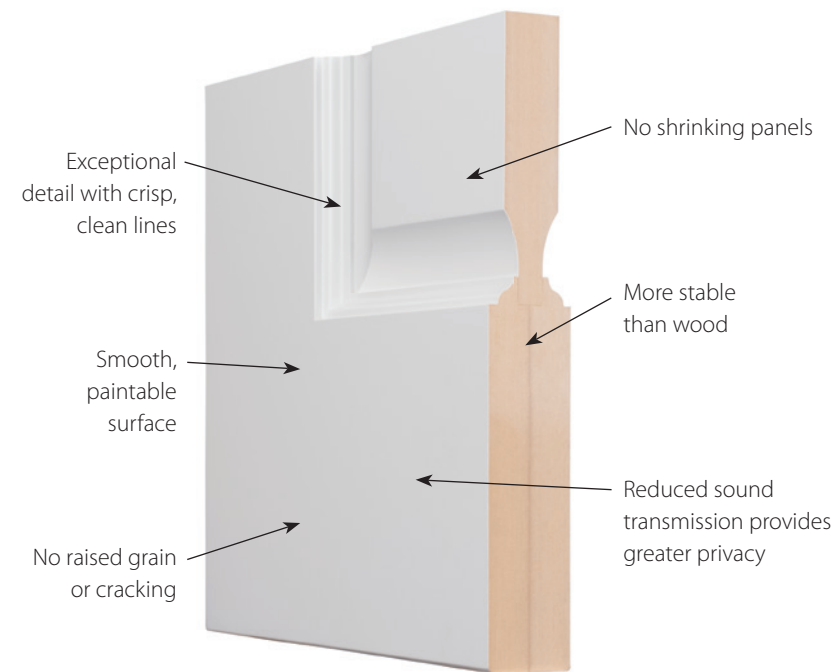

- Made to order and built to any size and style.
- Built with genuine stile and rail construction — never routed or stamped.
- Made with solid, super-refined MDF that provides a smoother painting surface than pine, poplar or lower-grade MDF alternatives.
- MDF is more stable than natural wood and less susceptible to movement and warping.
- More affordable than wood doors.
- Third party certified by Scientific Certification Systems to contain 69% recycled content, making them ideal for green building.

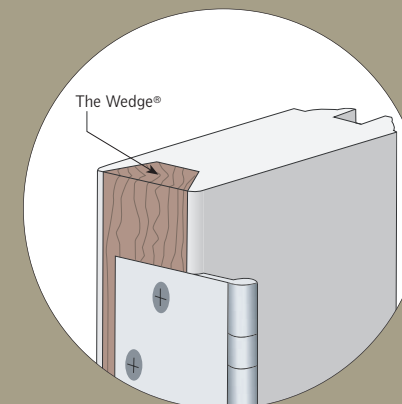

HARDWOOD WEDGE EDGE SYSTEM

TruStile MDF doors come standard with The Wedge,[®] our field-proven hardwood edge system. Designed to stand up to daily use, The Wedge provides superior rigidity, stability and screw-holding power.

TM13340 in Walnut with
Edelman® Royal Hide
Pewter Leather

For the Most
Discerning Eye

TruStile Reserve™ Wood Doors

Designed to the highest level of quality, TruStile Reserve™ Wood Doors are the ultimate expression of luxury for today's interiors and are constructed using the latest technological advances combined with meticulous hand craftsmanship.

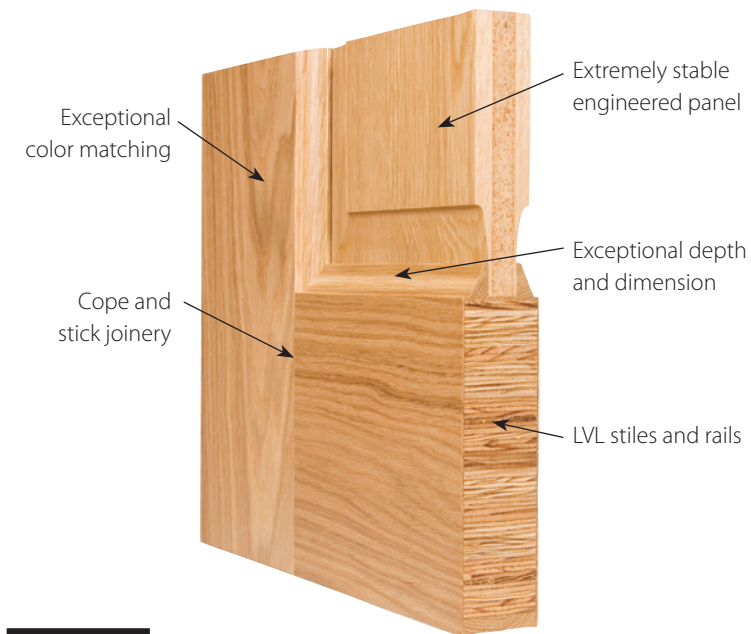

TRUSTILE
RESERVE™

- The TruStile Reserve series incorporates only the finest materials and methods. We have developed a proprietary specification based on the AWI (Architectural Woodwork Institute) standard for AA Premium Grade doors.
- Engineered panel made with a composite core for strength and stability while maintaining the look of a solid wood panel construction.
- Precision-cut cope and stick joinery for a meticulous, uncompromising look.
- The strength and durability of LVL is employed for the ultimate in stiffness to resist bowing, twisting or warping.

EXCEPTIONAL HAND-MATCHED VENEERS

TruStile created a proprietary color matching and grading system to ensure only the best veneers and lumber are used to handcraft your door. Based on the AWI AA Premium Grade standard, but taken a step further, TruStile Reserve Doors are unmatched in beauty.

For the
Harmonious
Home

TruStile Wood Doors

Made in the authentic stile and rail manner, TruStile Wood Doors use a premium mix of materials that exceed industry standards for a truly natural look.

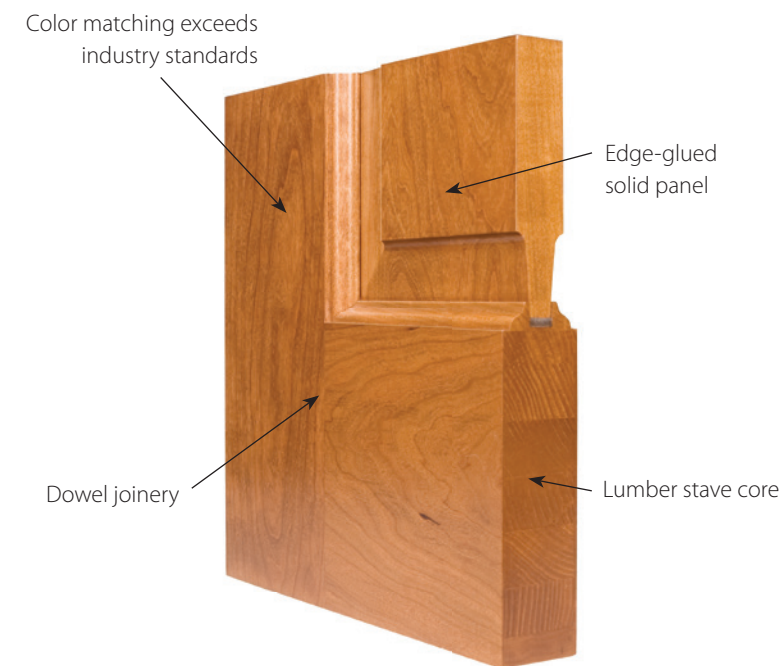

- Parts are tested and sorted into a premium mix of components that exceed industry standards. All components are blended for color and grain pattern matching.
- Edge-glued solid wood panels for a premium look and feel.
- Traditional dowel construction enhances strength and durability.
- An engineered stave lumber core is cut to size with alternating grain patterns, which balances the core and reduces wood's natural tendency to move.

Floating Panel System

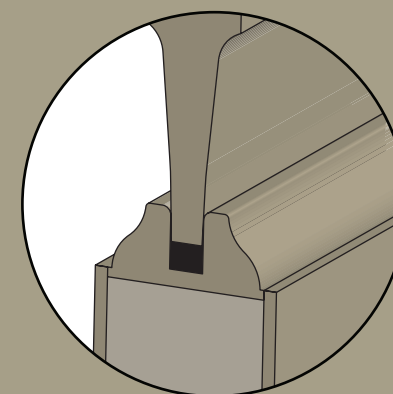

PANEL RETENTION

TruStile doors are engineered with a unique floating panel system that allow expansion and contraction while securing the panel to prevent shifting, settling and rattling. Flexible cushions are inserted into the stile and rail grooves followed by the panels that rest against them. The cushions allow the wood to expand and contract while holding the panel in position.

TS3010 in Cherry with
Roman Ogee (OG) sticking
and Raised (A) panel



Wood Species

We offer the broadest selection of wood species on the market. Choose from 20 standard selections of the finest, hand-selected veneers and lumber. Or custom order virtually any species.



Bamboo

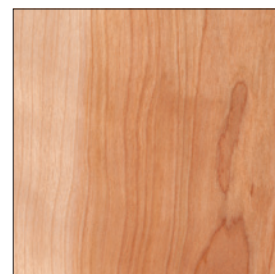

Birch

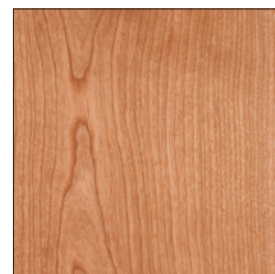

Cherry



Clear Pine



Wire-Brushed Clear Pine



Douglas Fir
(Vertical Grain)

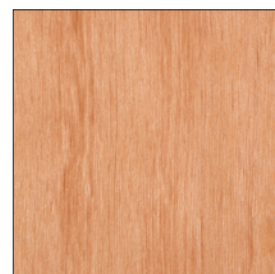

Wire-Brushed Douglas Fir
(Vertical Grain)

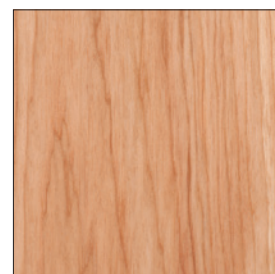

Hickory

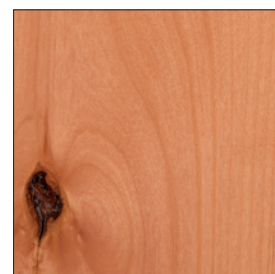

Knotty Alder

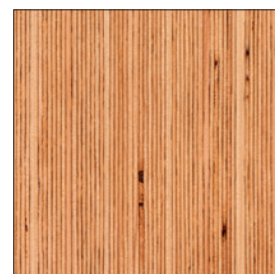

LVL



Mahogany



Poplar

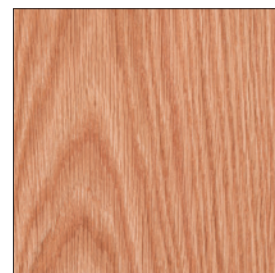

Red Oak

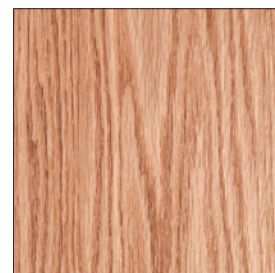

Wire-Brushed Red Oak



Select Alder

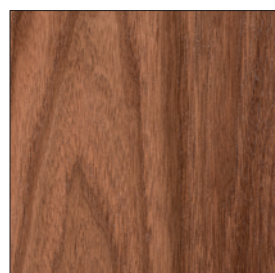

Walnut

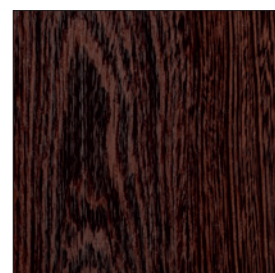

Wenge



White Maple

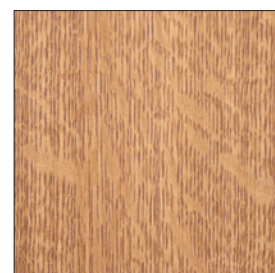

White Oak
(Quarter Sawn)

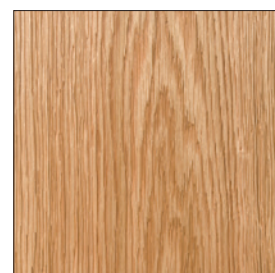

Wire-Brushed White Oak
(Plain Sawn)

Perfection is in the Details

Factory Pre-Finishing

TruStile offers a premium finishing capability that accentuates the natural beauty of our doors. Our exclusive process combines hand-wiped stains with a catalytic conversion varnish that results in an exceptionally beautiful finish luster.

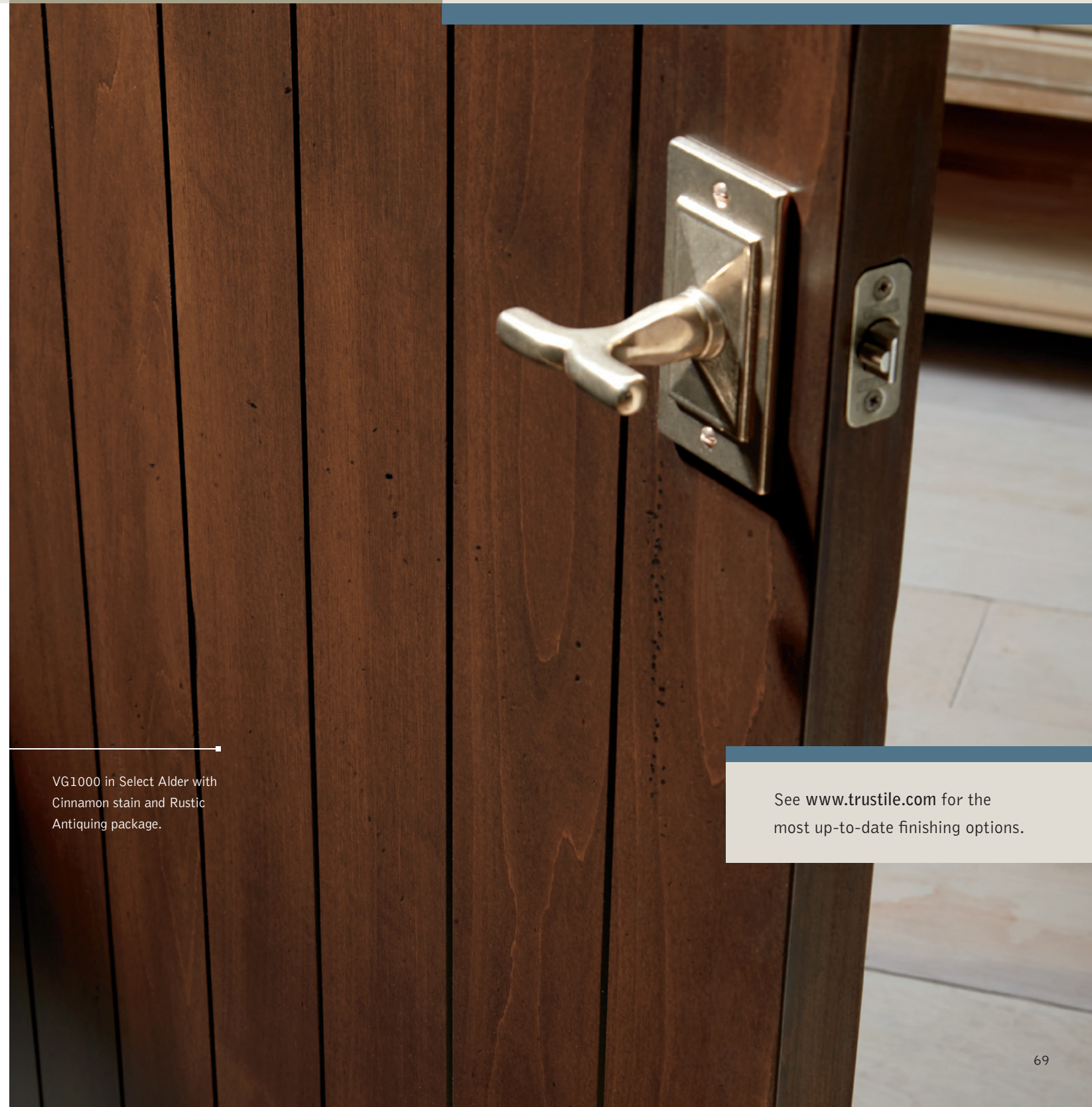

VG1000 in Select Alder with Cinnamon stain and Rustic Antiquing package.

See www.trustile.com for the most up-to-date finishing options.

Exterior Doors

TruStile offers most panel and glass styles in exterior-grade MDF and natural wood. Built with our stile and rail process, exterior doors are backed by our limited lifetime warranty when properly finished and installed with proper overhang protection.

EXTERIOR MDF DOORS

TruStile's exterior MDF doors receive specially engineered stiles, rails, and panels, along with an exterior-grade MDF material, to ensure they perform in changing environmental conditions. In addition, all exterior MDF doors receive our exclusive TruBolt system with threaded bolts running through the top and bottom rails to ensure structural integrity.

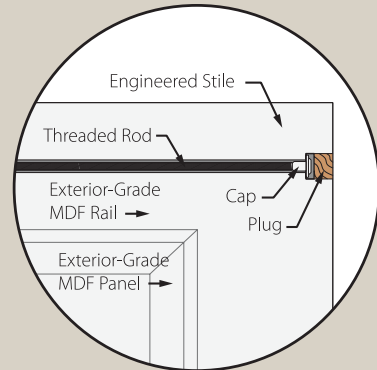

All exterior MDF doors come with our exclusive TruBolt system for added strength



TS5000 in exterior-grade MDF with White Lami glass



TM5100 in Walnut with White Lami glass

TRUSTILE RESERVE EXTERIOR WOOD DOORS

TruStile Reserve exterior wood doors come with engineered LVL stiles & rails that are triple doweled for optimal strength and security. Our Sentry Protection System provides an additional barrier to the elements with a polyurethane sealed channel around the full perimeter of all panels and glass.

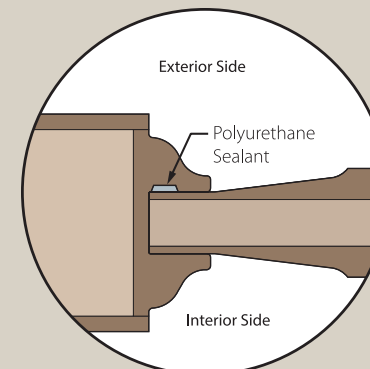

The Sentry Protective System provides a weatherproof seal around all panels and glass



Factory Pre-Hanging

Like our doors, TruStile's pre-hung units are built using premium construction techniques. Available as either pre-hung units or knock-down jambs, TruStile can supply any width and any species for any size door.

Available Hinge Finishes





Edelman® Leather

Substitute any panel with the finest Edelman leather. Select either a laminated or upholstered finish to refine your design.

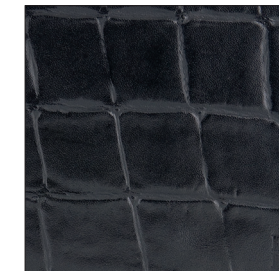

Croc Black

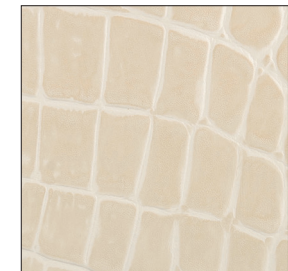

Croc Marble

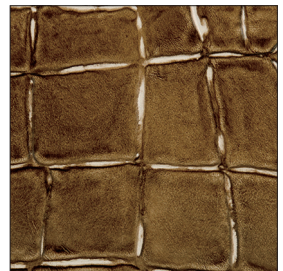

Croc Nuts



Shagreen Caviar

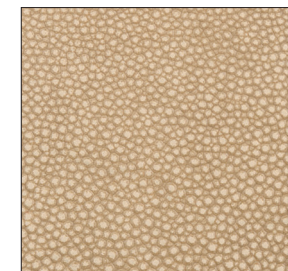

Shagreen Couscous



Shagreen Grey Oyster



Sulky Bridle

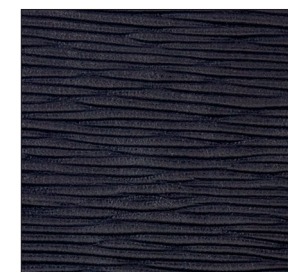

Sulky Grey Mare



Sulky Marmalade



Oak



Old Cherry



Pampas

In addition to our 12 standard color ways, visit www.edelmanleather.com for hundreds of additional choices.

TS3000 in walnut with Edelman® Croc Nuts leather panels.

Chemetal® Inserts

High-quality wood and imaginative finishes combine for an entirely new perspective on what a modern interior can be. Choose the insert that inspires you.



Brushed Aluminum



Brushed Brass



Brushed Bronze

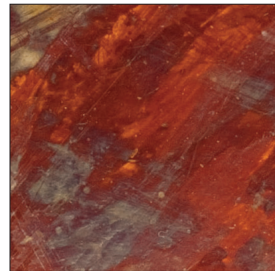

Patina Aurora

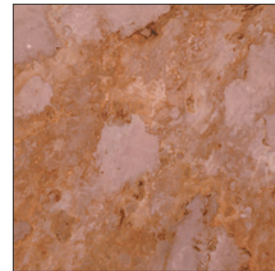

Patina Canterbury

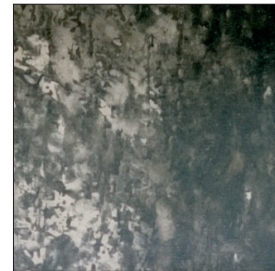

Patina Monet

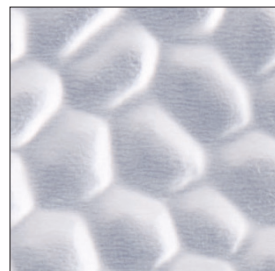

Hammered Argenta

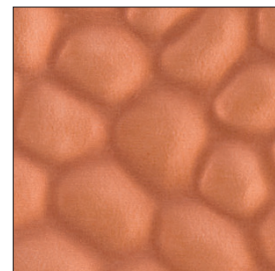

Hammered Cobblestone

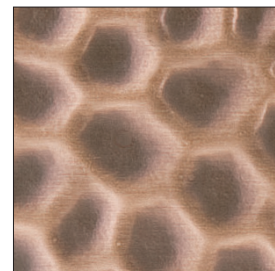

Hammered Reptilian

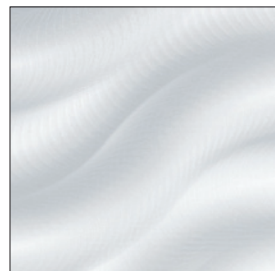

Serpentine



Venetian Vertical

TM3000 in MDF with Patina Monet panels



In addition to our standard finishes, visit www.chemetal.com for hundreds of additional choices.



Innovative Glass and Resin

Replace most any panel with the latest trends in architectural glass from Bendheim® or designer resin from 3Form®

Visit bendheim.com or 3-form.com for more custom choices.

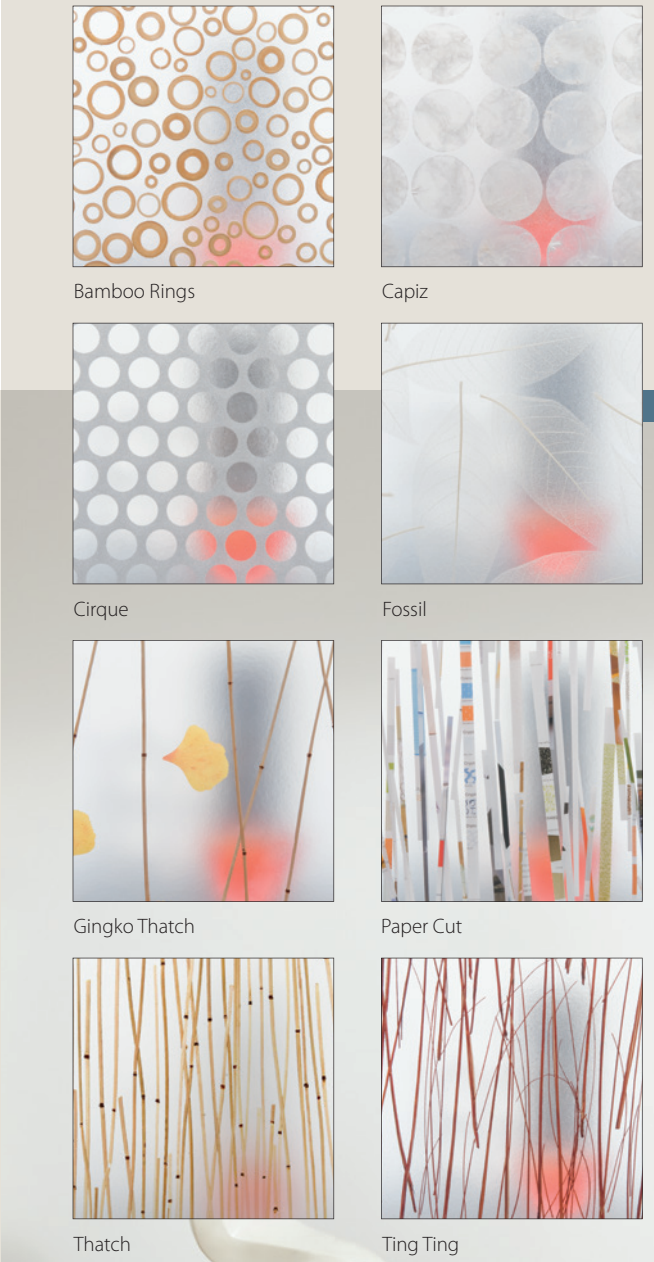
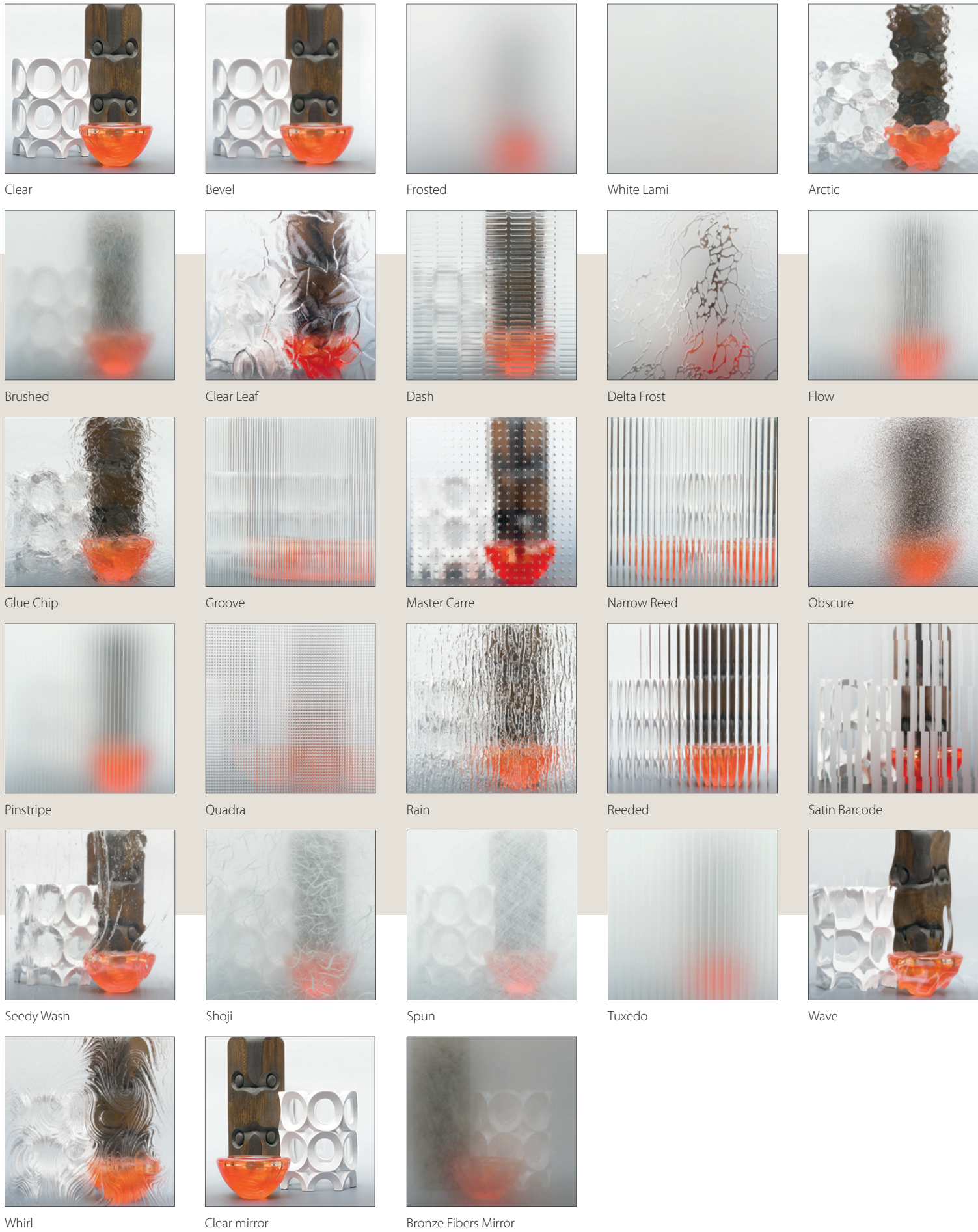

AD1030 in LVL with Gingko Thatch resin



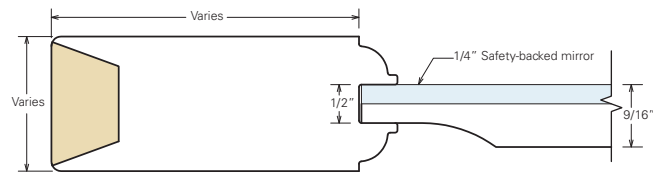

Sample cross section (one-sided mirror door)

Built-In Mirrors

TruStile mirror doors add a new dimension to any space. Our mirror doors are a perfect space-saving solution for bathrooms, closets, dressing rooms and other applications where a full-length mirror is required on one side.

Achieve total design form and function by substituting any wood panel for a mirror. Standard options include clear mirror and bronze fibers mirror.



Clear mirror



Bronze Fibers mirror

REFLECT THE HIGHEST STANDARDS

Specify a full-length, built-in mirror on the back of any of our panel doors.

Custom Etched Glass

Looking for something special for a pantry, wine cellar or office door? TruStile can custom etch any pattern, word or logo onto your glass doors.



Backside of TM9000 in MDF features built-in mirror. TM5000 with White Lami glass on right.

Customize Your Doors with Unique Options

Design Options

TruStile's made-to-order flexibility makes it easy to customize the look of our 400+ standard doors with a collection of unique door options.



VG2020 AT in douglas fir

Arch-top doors



TS4070 RT in MDF

Radius-top doors



TM6100 in White oak with Shagreen Grey Oyster leather

Sliding barn doors



FL1500 in mahogany

Pocket doors



TS3160 in MDF

Bi-fold doors



VG2020 in MDF

Bypass doors



TM9140 in LVL with custom metal

Pivot doors



TS2060 in MDF

Clipped corner doors

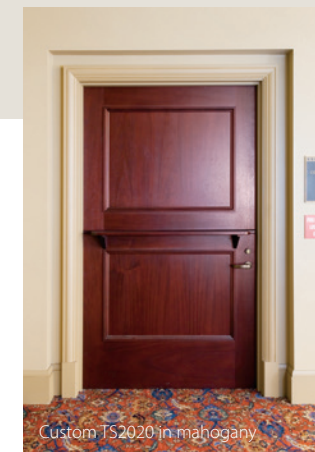

Custom TS2020 in mahogany

Dutch doors

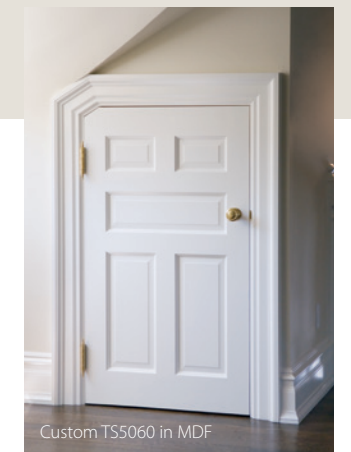

Custom TS5060 in MDF

Specialty doors



TS3040 standard pair



TS3040 common arch pair

Common Arch Pairs

Rather than placing two matching doors side by side, common arch pairs carry details across both doors, such as curved panels and rails. The end result? The doors actually look like they were made for the opening. Common arch pairs are also available with arch and radius tops.



VG4030 barn door in MDF



Sliding Barn Doors

We've re-imagined our entire product offering of 400+ styles to make them compatible for barn door openings. As the width increases, the design changes to create the appropriate look.

Rustic (VG4030 shown)

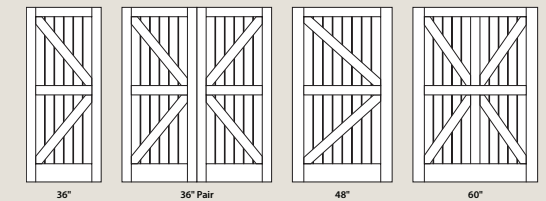

Craftsman (PL244 shown)



Traditional (TS3040 shown)

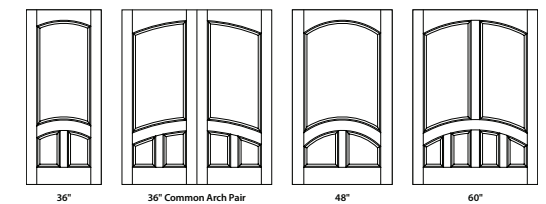

Modern (TM9110 shown)

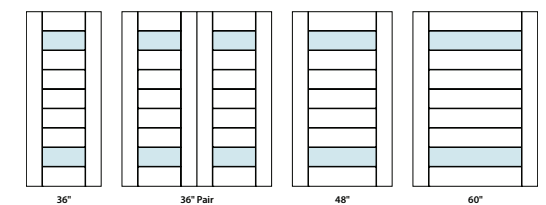



Tru&Modern Infinite Rail Doors

Modern architecture demands exacting specifications. The Tru&Modern Infinite Rail brings a luxurious level of sophistication with kerf cuts or metal inlays that traverse the complete width of the door.

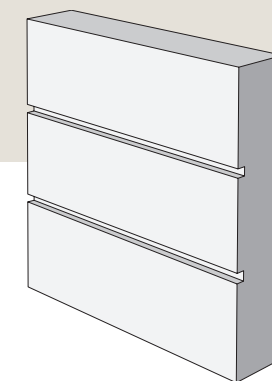

1/4" Kerf Cut Reveal

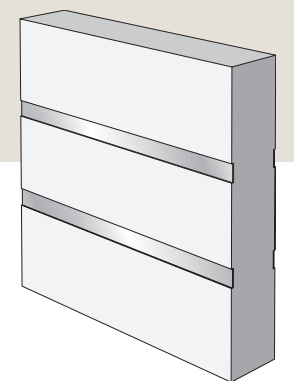

1/2" Bright or Brushed
Stainless Inlay

TMIR6080 in Mahogany with Espresso stain and 1/2" Bright Stainless Steel Inlay

Tiered Mouldings

The Linea, Miracle and Avant Mouldings bring interest and dimension to square panel doors. These timeless styles enhance traditional designs with a dynamic, contemporary look.

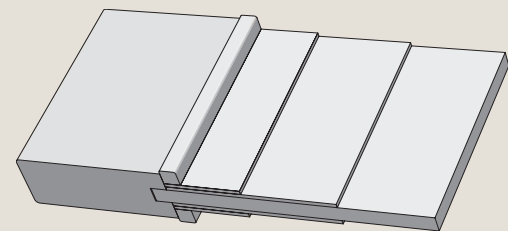

Linea Moulding

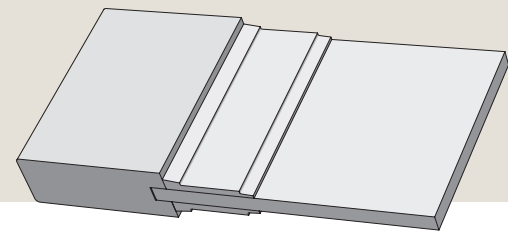

Miracle Moulding

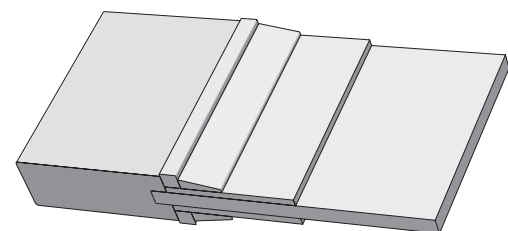

Avant Moulding



TS2060 in MDF with Linea (LN)
Moulding and Flat (C) panel



VG1000 Plank Door in Select Alder with Cinnamon stain with Rustic Antiquing package

Plank Doors

Achieve the genuine look of rustic plank doors or create your own contemporary version of this ageless design. Multiple profiles, plank widths and finishing options make it all possible.

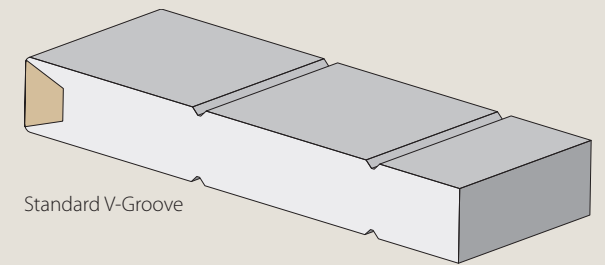

Standard V-Groove

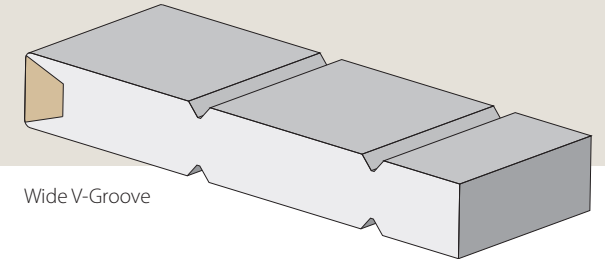

Wide V-Groove

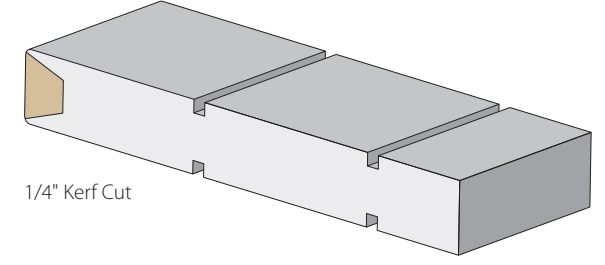

1/4" Kerf Cut



Wall Finish
by
GORMAN CUSTOM
FINISHES

TS5080 in White Oak with Quirk moulding, with metal inlay, and White Lami glass



Commercial Applications

From hospitality and high-end multifamily projects to health care and educational institutions, TruStile provides the right finishing touches for distinctive projects across the United States.

TruStile doors can be built to meet any commercial specification — including 20- through 90-minute fire ratings, ADA requirements and sound ratings.

Transform Openings & Elevate Your Project

TruStile designs premium doors for a wide array of market segments and distinctive properties across the United States.



Design Consistency Regardless of Function

Providing ultimate design flexibility, TruStile offers a spectrum of products for every project application. Whether passage, glass, fire or sound doors, TruStile allows you to maintain design consistency across all of your openings.

RECENT PROJECT PORTFOLIO

Hospitality

Boutique Hotels & Spas

Ace Hotel
Albany Bahamas
Algonquin Hotel
The Jefferson Hotel
Lake Yellowstone Hotel & Cabins
Little Dix Bay
Mills Park Hotel
Mirbeau Inn & Spa
Win-River Resort & Casino

Resorts & Destination Hotels

Fairmont Hotel—San Francisco
Four Seasons—Boston
JW Marriott—Washington DC
Hilton—Nashville
Hilton—Waikola
Marriott—West Palm Beach
Millennium—Scottsdale
Omni Hotel—Amelia Island
Renaissance—Aruba
Renaissance—Austin
Ritz Carlton—St Thomas
Sheraton—Steamboat Springs
Westin—Atlanta
Westin—Hilton Head
Wyndham—Puerto Rico

Education

Auburn University
—Duncan Hall
Butler University
—Delta Gamma
Columbia University
—Teachers College
Cristo Rey High School
Dartmouth College
—Kappa Delta
Middlesex School
Notre Dame Community Housing
Pepperdine Student Apartments
Phillips Exeter Academy
University of New Haven Dormitory
Vassar College

Healthcare

Cohasset Senior Center
Cosmetic Surgery Center of Maryland
Brightmore of South Charlotte
Friendship House at Royal Oaks
Mount St Joseph
OK Kids Korral
Tockwotton on the Waterfront

Government/Public

Chester County Courthouse
Denver Union Station
Dumbarton Oaks
Fort Poke Office Building
Santa Cruz Women's Shelter
Sumter County Courthouse
Presidio Officer's Club

Office/Retail

Athleta/Gap/Banana Republic
Bass Pro Shops
Beverly Bank
Chicago Motor Club
First Southern Bank
Goldring Office Building
Grubbs Infiniti Dealer
Waters Professional Building
White House Black Market

Multi-Family

333 North Michigan Avenue
530 Park Condo
1301 North Astor Street
—Phillip Maher Building
Adam Gordon's 560 West Chelsea
The Aurora Apartments
The Austonian
Coronado Bay Club
Huys—404 Park Avenue South
Hotel Sorella Residences
Loews North Park Drive
Mansions at Aqualina
Old Mill Toronto
Printhouse Lofts, Brooklyn
Rittenhouse Plaza
The Shire
Two Twenty Four Mulberry Street
Uptown Condos

Entertainment

Canoe Brooke Country Club
Charles River Country Club
Cuban Museum
Eugene O'Neill Theater Center
Gaithersburg Art Barn
The Hermitage Club
Jazz and Heritage Center
Kansas State Casino
Noah's of Katy at Mason Creek
Universal Studios/Harry Potter
Woodforest Golf Club

Religious

Benedictine Sisters Retreat Center
Good Shepard Catholic Church
Mission Del Ray
Parkside Church
St George Christian Church



TS2020 in MDF with custom sticking



TM9000 in White Oak



TS2080 in Mahogany



Custom LVR2020 sliding barn doors in MDF



TS5000 in MDF with White Lami glass

Design that Complements the Planet

Our modern, domestic plants use lean manufacturing practices to make extremely efficient use of our raw materials. This minimizes waste and environmental impact.

69% Recycled MDF Doors for Painted Applications

TruStile MDF doors are not only the highest quality paintable doors on the market, they are also the responsible environmental choice. We recycle MDF waste, donating it to agricultural partners who use it to create energy, reducing both landfill waste by 65% and waste pick ups, putting fewer trucks on the road. The green benefits of our MDF doors include:

- Certified by SCS Global Services to be constructed of 69% recycled content.
- Eligible for up to three LEED® credits
- Manufactured with low-emitting adhesives and coated with low-emitting primer.
- Standard MDF is low emitting, meeting CARB (California Air Resources Board) requirements.
- A no-added formaldehyde MDF option is also available.



MINIMUM 69% RECYCLED CONTENT PRE-CONSUMER



The mark of responsible forestry

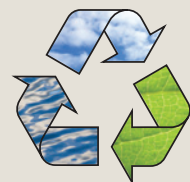

FSC® Certified Wood Doors for Stained Applications

Most TruStile wood doors are available with FSC certification. FSC certification ensures that products come from responsibly managed forests that provide environmental, social and economic benefits.

The green benefits of our FSC certified wood doors include:

- Third-party certification that all door materials originate from responsible sources.
- 100% of door value contributes towards the LEED credit for Certified Wood Products.
- Manufactured with low-emitting adhesives.
- Green-certified doors contain the same high-quality construction and materials as our standard product.

Use TruStile on Your Next LEED® Certified Project

The LEED® (Leadership in Energy and Environmental Design) Green Building Rating System is a national standard developed and published by the U.S. Green Building Council (USGBC). Its purpose is to promote sustainable building that is environmentally responsible, profitable and healthy. TruStile doors also qualify for other green building rating systems. Contact us for details.

TruStile Doors help achieve LEED credits in the following categories for new commercial construction and major renovation projects¹:

LEED credit	LEED criteria	Detailed requirement	TruStile MDF	TruStile Wood
Materials & Resources				
4.1 (1 point)	Recycled content: 10% (post-consumer + ½ pre-consumer)	Use materials with recycled content such that the sum of post-consumer recycled content plus ½ of the pre-consumer content constitutes at least 10%, based on cost, of the total value of the materials in the project.	Qualify—SCS certified to contain minimum 69% recycled content	Not eligible
4.2 (1 point)	Recycled content: 20% (post-consumer + ½ pre-consumer)	Use materials with recycled content such that the sum of post-consumer recycled content plus ½ of the pre-consumer content constitutes at least 20%, based on cost, of the total value of the materials in the project.	Qualify—SCS certified to contain minimum 69% recycled content	Not eligible
7 (1 point)	Certified wood	Use a minimum of 50%, based on cost of wood-based materials and products that are certified in accordance with the Forest Stewardship Council's (FSC) principles and criteria for wood building components.	Not eligible	Qualify—specify FSC Certified Wood Door 100% of door value counts toward credit
Indoor Environmental Quality				
4.4 (1 point)	Low-emitting materials: Composite wood and agrifiber products	Composite wood and agrifiber products used on the interior of the building must contain no added urea-formaldehyde resins.	Qualify—specify NAUF MDF	Qualify—specify NAUF MDF panel core

TruStile Doors help achieve LEED credits in the following categories for residential home construction projects²:

LEED credit	LEED criteria	Detailed requirement	TruStile MDF	TruStile Wood
Materials & Resources				
2.2 (0.5 points for doors)	Environmentally preferable products	Use building component materials that are environmentally preferable in that they either contain minimum of 50% post industrial recycled content, are FSC certified or reclaimed.	Qualify—SCS certified to contain minimum 69% recycled content	Qualify—specify FSC Certified Wood Door 100% of door value counts toward credit

¹ LEED for New Construction & Major Renovations, Version 3 (April 2009).

² LEED for Homes Rating System, Version 2008 (January 2008).

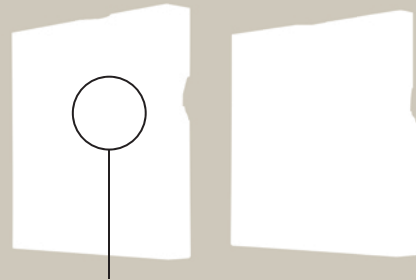

Profiles on fire-rated doors have true depth and definition, not plant-on mouldings.

Our Fire Doors are as Stylish as They are Safe

Designed to match non-rated doors, all TruStile fire doors feature full panel relief and are carefully engineered to complement our non-rated doors.

Non-rated TS3070 in MDF



20-minute fire-rated TS3070 in MDF



Matched Dimensions

Stile and rail dimensions can be matched between standard and fire-rated doors.

Certified Fire Door Ratings

Throw away the preconception that you have limited design options for fire-rated openings. With most of our standard panel doors available in up to 90-minute ratings, you never have to sacrifice style when selecting 20- through 90-minute fire doors.

	20-minute MDF	20-minute Wood	45- and 60-minute MDF/Wood	90-minute MDF/Wood
Category	Category A Category B Neutral Pressure	Category A Category B Neutral Pressure	Category A Category B	Category A Category B
Thickness	1 3/4" minimum	1 3/4" minimum	1 3/4" minimum	1 3/4" minimum
Maximum width single	4'0"	4'0"	3'6"	3'6"
Maximum width pair	8'0"	8'0"	7'0"	7'0"
Maximum height	8'0"	8'0"	8'0"	8'0"
Fire Glass max. area	3,145 sq. inches	3,145 sq. inches	1,248 sq. inches – 45 minutes 1,216 sq. inches – 60 minutes	1,216 sq. inches
Standards	ASTM E-152, NFPA 80, NFPA 252, UL10B, UL10C			

*Some door styles and panel profiles are not available in all fire ratings. Verify availability with TruStile.
**Some ratings require metal vision kits.

Fire Rated Glass Doors Also Available

Glass doors are the perfect solution for spaces where a fire door is required by code, but the look of a glass door is preferred. Select from over 120 fire-rated glass doors with any of our standard sticking profiles. Refer to the fire-rated symbol  in the Door Collections section to see which glass door designs are available in 20-, 45-, 60- and 90-minute fire ratings. Hose stream-approved glass can also be specified.

TS4100 in Maple



20-minute fire-rated TS3190 in Walnut



Keep Private Conversations Private

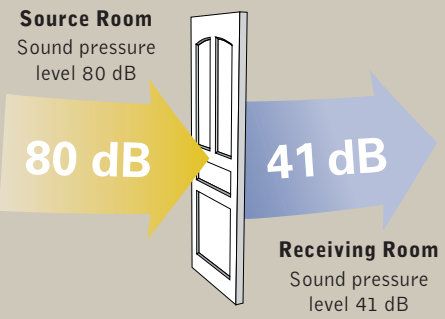

Superior Sound Performance

Noise is an inescapable component of life in the modern home. Because of their weight, solid construction and high density, TruStile doors are the ideal solution to sound proofing a home.



Home theater featuring TS3070 in Mahogany with custom porthole window

Sound Transmission Class (STC) Ratings

TruStile has tested its sound doors in operable openings with Zero International sound gasketing packages.

STC rating	Door material	Door styles	Door thickness	Primary seal	Secondary seal	Threshold saddle	Sweep
Zero International hardware used							
39	MDF and wood	60-minute fire door	2¼"	#475	#119	#564	#367
38	MDF	90-minute fire door	1¾"	#188FS	#118B	Flat surface	#369
34	MDF	20-minute fire door	1¾"	#188FS	#118B	Flat surface	#369
34	MDF	TS5000 — TS9000	1¾"	#475	#119	#564	#367
33	MDF	TS1000 — TS4000	1¾"	#475	#119	#564	#367
32	MDF	TS5000 — TS9000	1¾"	#475	N/A	#564	N/A
32	Wood	TS1000 — TS4000	1¾"	#475	#119	#564	#367
30	MDF	TS1000 — TS4000	1¾"	#475	N/A	#564	N/A
30	Wood	TS1000 — TS4000	1¾"	#475	N/A	#564	N/A
30	Wood	TS5000 — TS9000	1¾"	#475	#119	#564	#367

Sound Transmission Class (STC) Examples

TruStile Advantage	STC	Performance	Description
	50 – 60	Excellent	Loud sounds heard faintly or not at all
	40 – 50	Very Good	Loud speech heard faintly
TruStile Door with Correct Gasketing	35 – 40	Good	Loud speech heard but hardly intelligible
	30 – 35	Fair	Loud speech understood fairly well
	25 – 30	Poor	Normal speech understood easily and distinctly
Typical Hollow-Core Door	20 – 25	Very Poor	Low speech audible

Sound ratings are classified by an STC (sound transmission class) number that rates a material's ability to resist airborne sound. A higher STC rating blocks more noise from transmitting through a partition like a door. Standard TruStile MDF doors achieve up to a 34 STC rating, some 10- to 15-points better than typical hollow-core doors that achieve a "very poor" rating. For openings requiring even better sound performance, TruStile can provide 60-minute wood and MDF fire doors that achieve up to a 39 STC rating.



TS3000 in Mahogany with Linea tiered moulding



TS3000 in MDF with White Lami glass

The Extensive TruStile Door Collection

Find the ideal design that enhances your home's architectural style and completes its distinctive look.

**UNLIMITED
POSSIBILITIES**

Choose from over 400 door styles and 66 profile options.



TS3080 in Knotty Alder

TS Door Collection

Our TruStile (TS) Door Collection features over 100 architecturally-correct panel door styles from one- to nine-panel configurations. Each door is built with genuine stile and rail construction and is never routed or stamped. As a result, our panel doors have crisp, clean lines and unmatched detail.



TS3000 in MDF

TS Series Door Styles

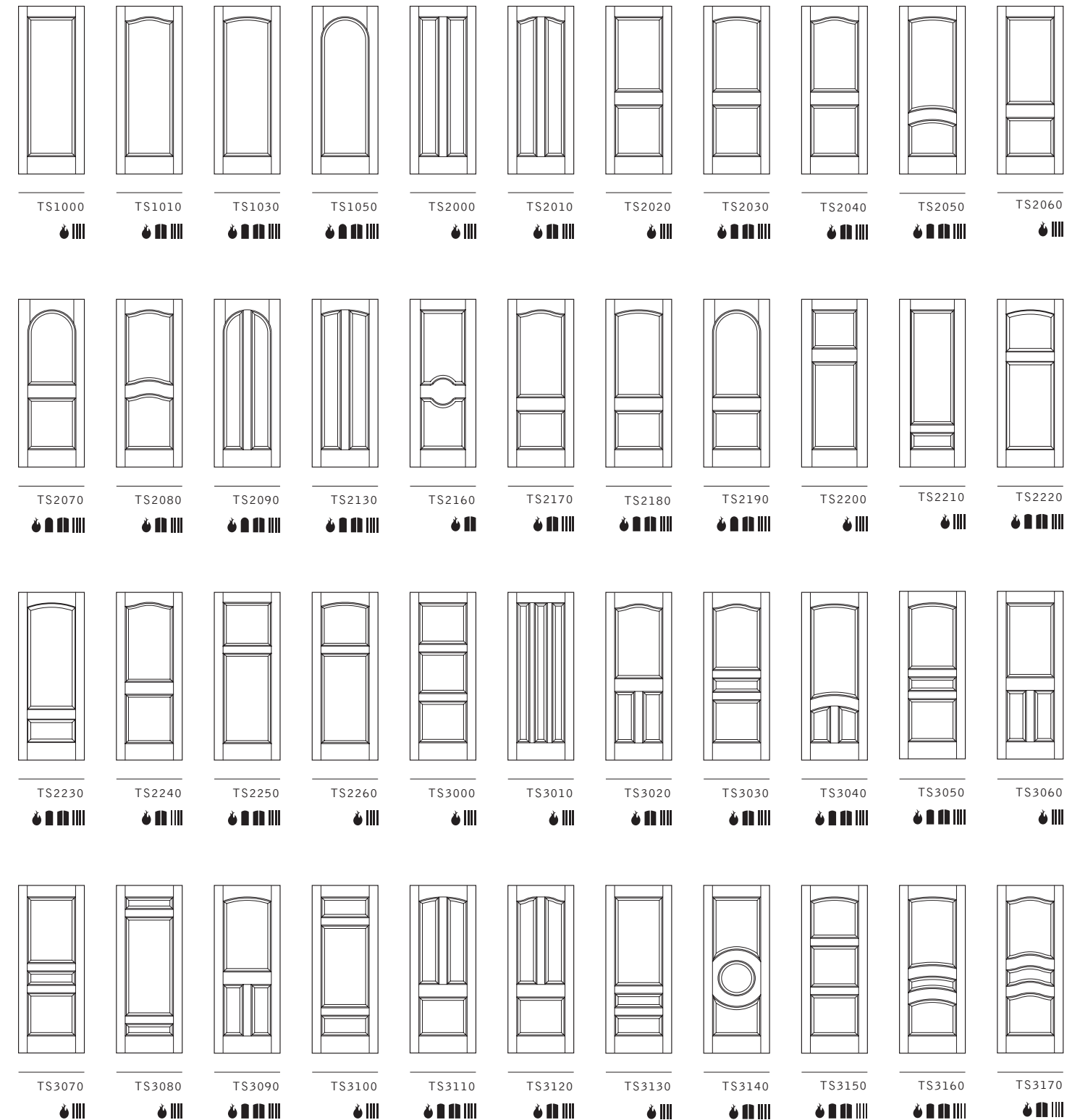

Available as a fire-rated door*
 Arch-top option available
 Common arch pair option available
 Bi-fold closet option available
 Available in MDF only

*Contact TruStile to confirm exact fire ratings and available sizes

TS Series Door Styles

TS Series Door Styles

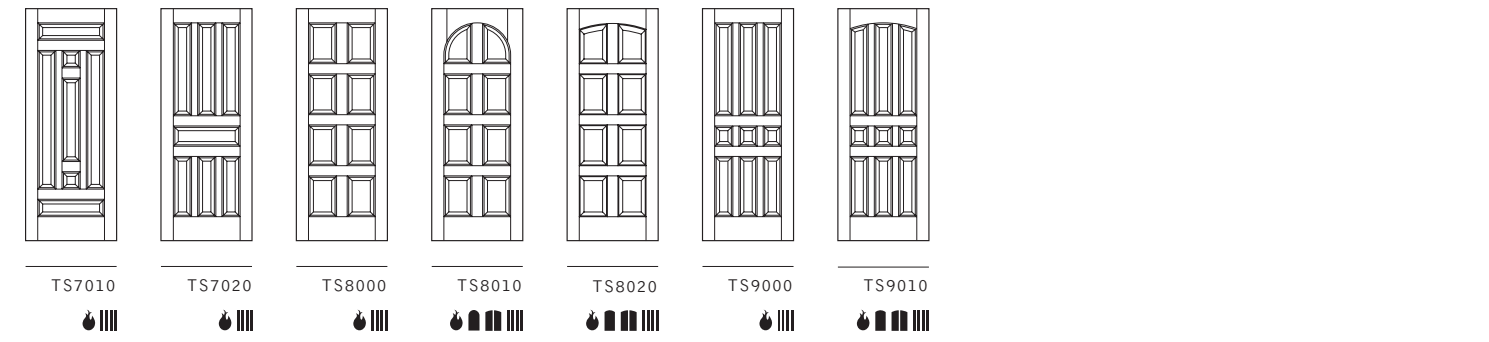
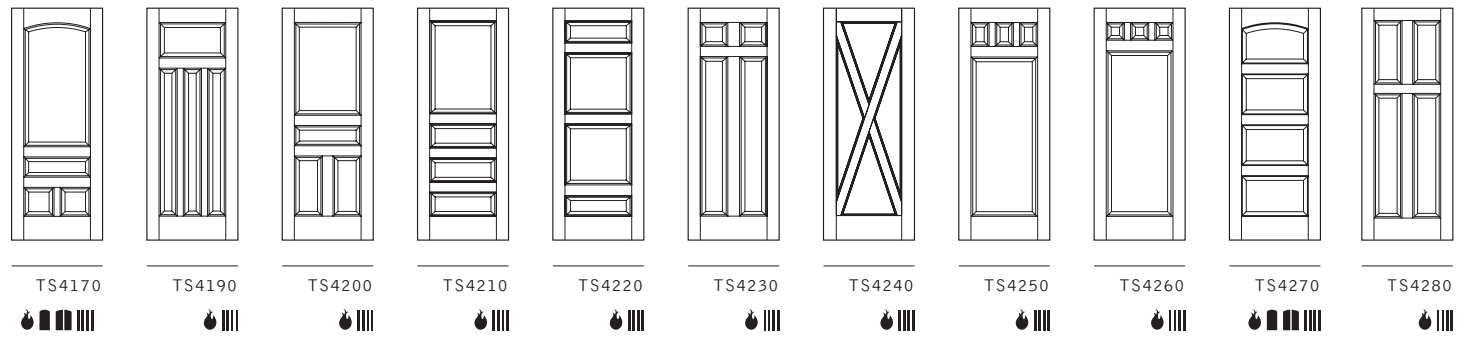
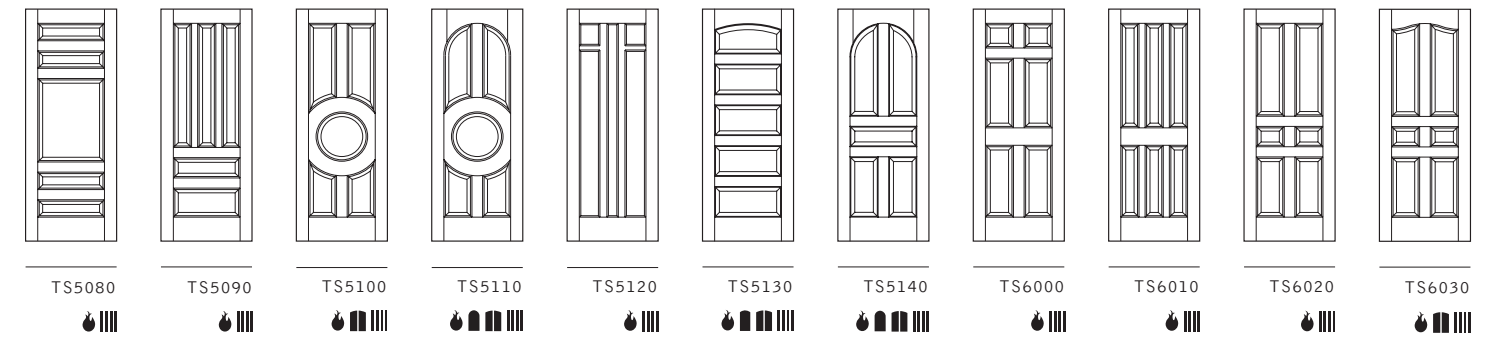
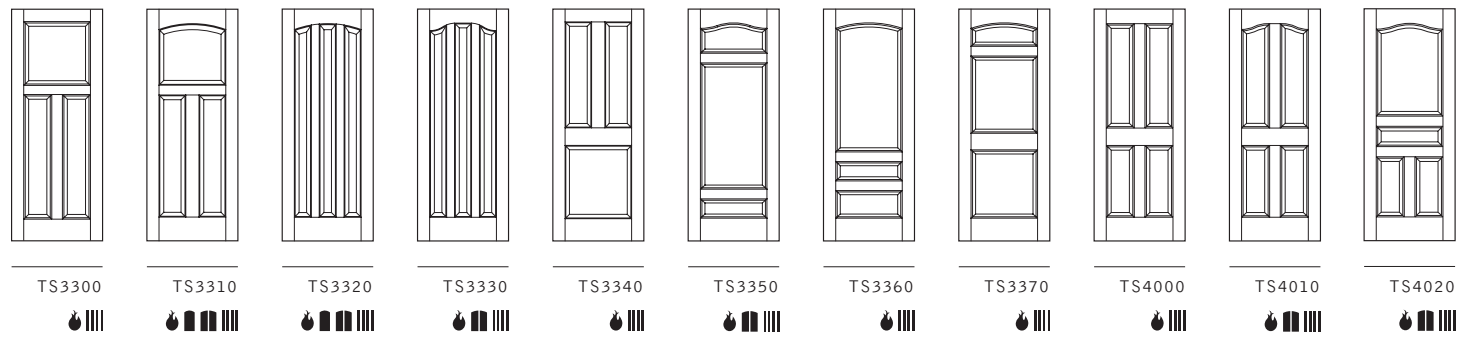
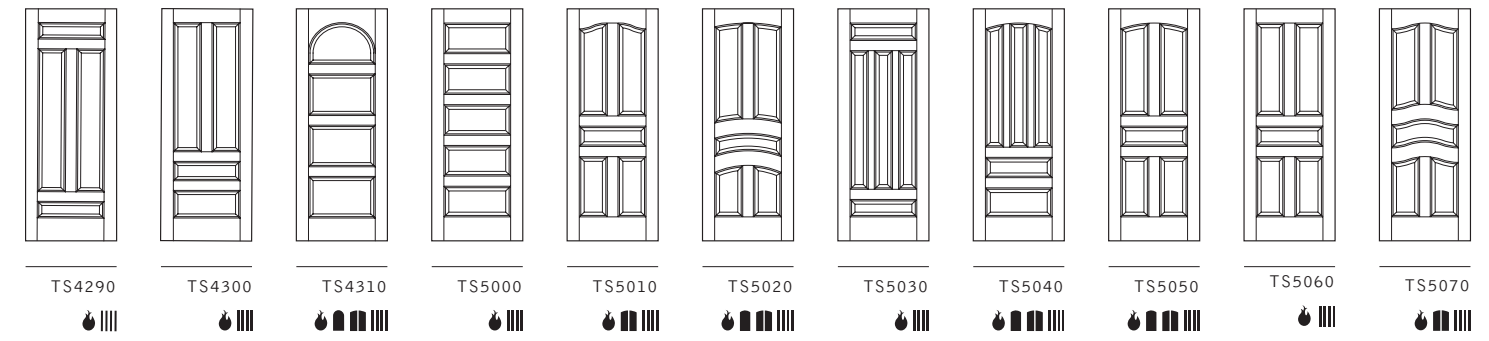
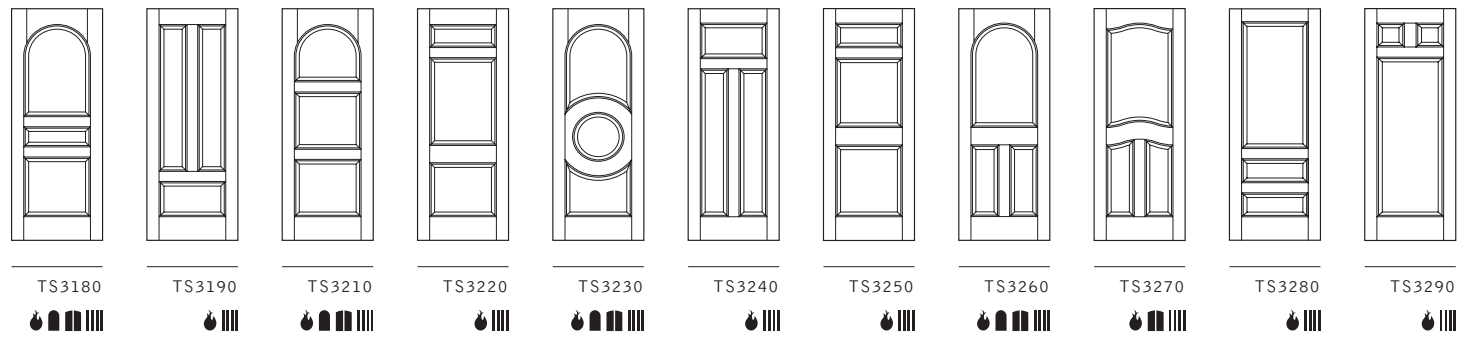

Available TruStile
 Product Options
 Available as a fire-rated door*
 Arch-top option available
 Radius-top option available
 Common arch pair option available
 Bi-fold closet option available
 Available in MDF only
 *Contact TruStile to confirm exact fire ratings and available sizes

Available TruStile
 Product Options
 Available as a fire-rated door*
 Arch-top option available
 Radius-top option available
 Common arch pair option available
 Bi-fold closet option available
 Available in MDF only
 *Contact TruStile to confirm exact fire ratings and available sizes

TS3070 in MDF with Roman Ogee (OG) sticking and Raised (A) panel



Panel Door Profile Options

A door profile refers to the joint where the sticking and panel come together. You can achieve distinct looks by selecting different sticking and panel combinations. With so many combinations to choose from, we're confident you'll find the perfect profile for your project. If not, we can partner with you to create a custom profile.

Sticking Profile Options

Roman Ogee (OG)

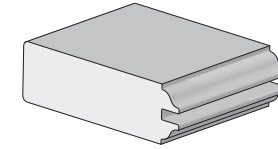

Cove & Bead (CB)

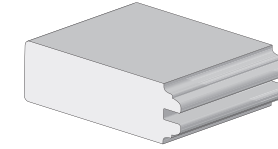

Quarter Bead (QB)

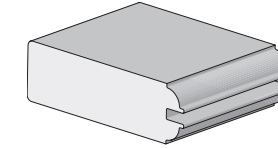

Quarter Round (QR)

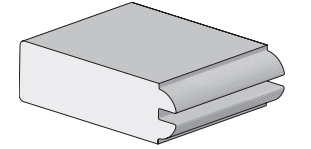

Bevel (BV)

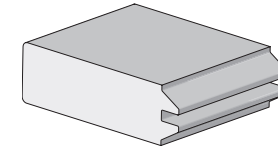

Square Stick (SS)

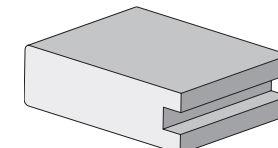

One Step (OS)

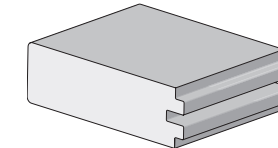

Quirk Moulding (QM)

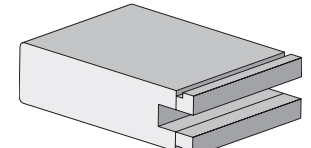

Low Profile Bolection Moulding (LP)

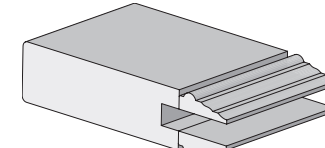

Bolection Moulding (BM)

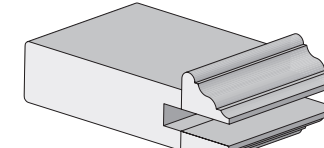

Big Bolection Moulding (BBM)

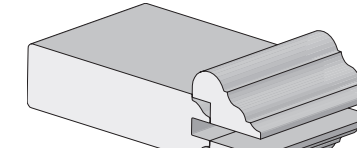

Miracle (MR) Applied Moulding

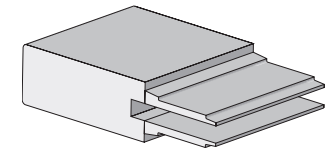

Avant (AV) Applied Moulding

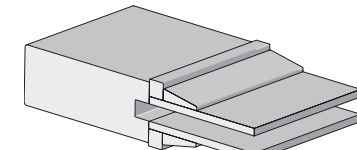

Linea (LN) Applied Moulding

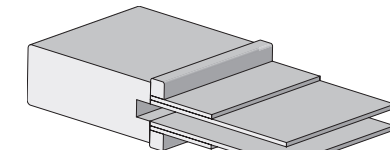

Panel Profile Options

"A" Raised Panel

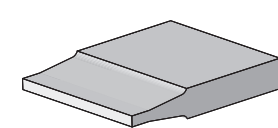

"B" Scoop Panel

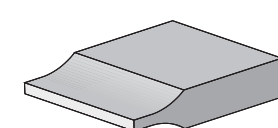

"C" Flat Panel

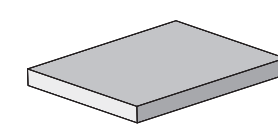

"D" Double Hip Panel

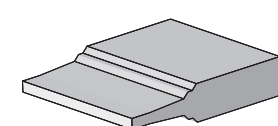

"E" Senior Raised Panel

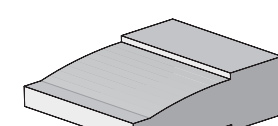

"F" Senior Bevel Panel

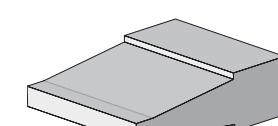



TM Door Collection

The Tru&Modern™ (TM) Door Collection consists of over 100 contemporary door styles. A modern take on classic stile and rail door construction. Clean, strong lines. Custom design options. Bold accents. This collection radically alters the concept of what a door can bring to today's modern and contemporary interiors.



TM Series Door Styles: New Configuration Door Series

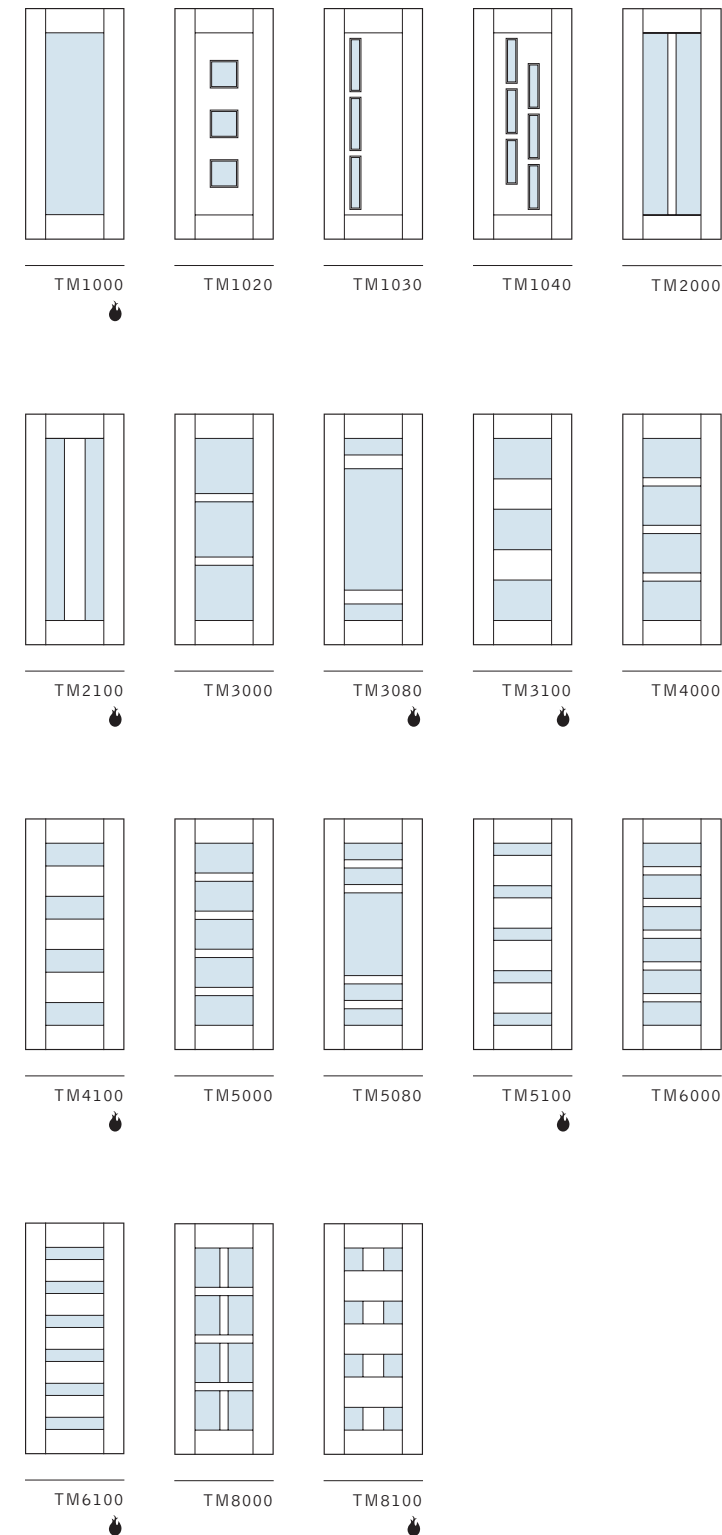

Tru&Modern Profile Options

TM New Configuration door designs are available with two profile options to frame the desired insert:

Square Stick (SS) Compression Fit

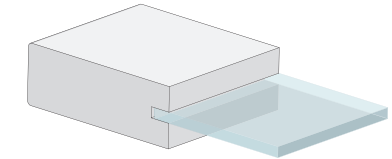

Compression fitting not available for leather inserts. Glass can not be replaced on compression fit doors.

Square Stick (SS) Sash

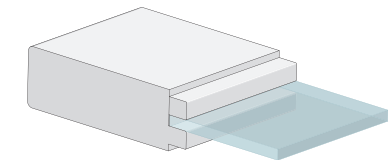

Square Stick sash not available for wood panels. Use One Step (OS) sticking to match Square Stick (SS) sash around wood panels.

Note: Door styles are shown with the new modern wide stile. Shaded panels indicate an insert option: leather, metal, glass, resin or a flat wood panel.

Available TruStile
Product Options

Available as a fire-rated door*
Arch-top option available

Radius-top option available
Common arch pair option available

Bi-fold closet option available
Available in MDF only

*Contact TruStile to confirm exact fire ratings and available sizes

TM Series Door Styles:

9 Stacked Rail Series

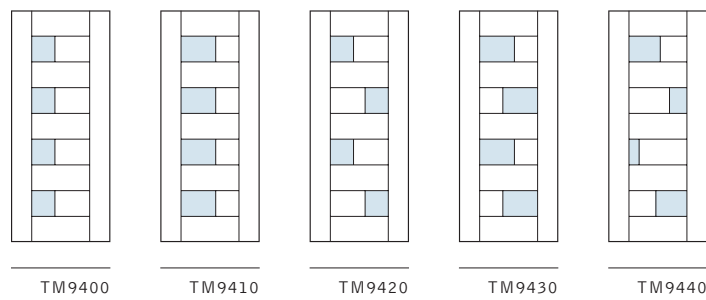
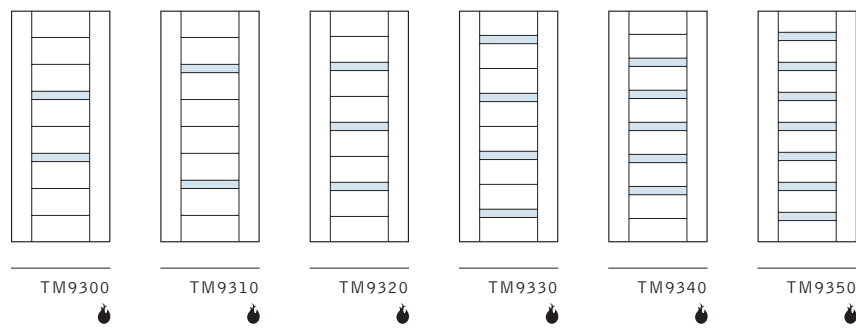
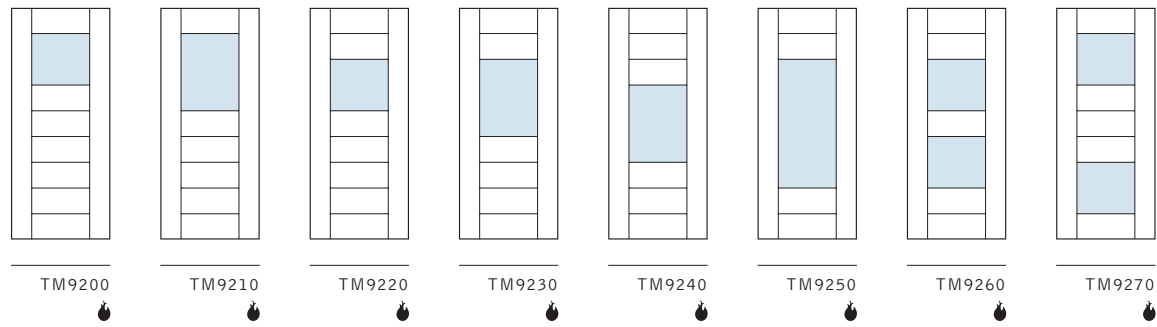
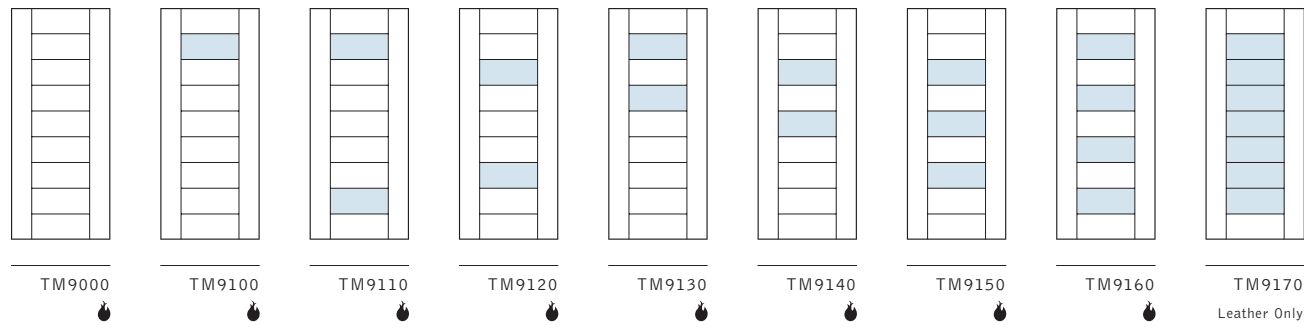

Tru&Modern™ Series Reveals

TM stacked rail door designs are available with two reveal options:

1/8" Radius Reveal

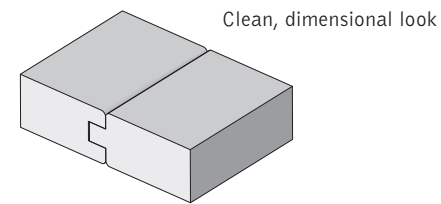

1/4" Kerf Cut Reveal

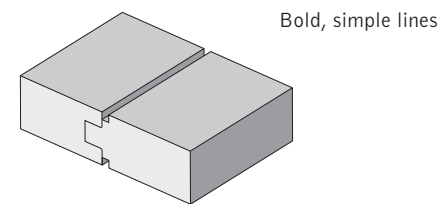

TM Series Door Styles:

13 Stacked Rail Series

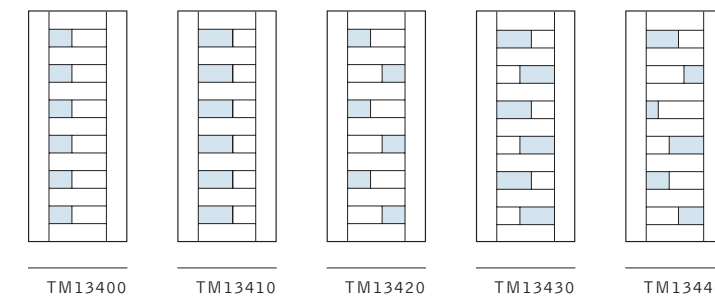
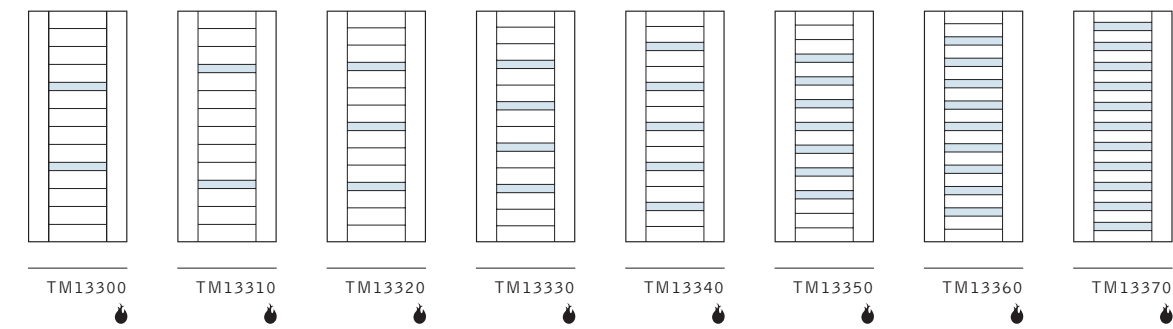
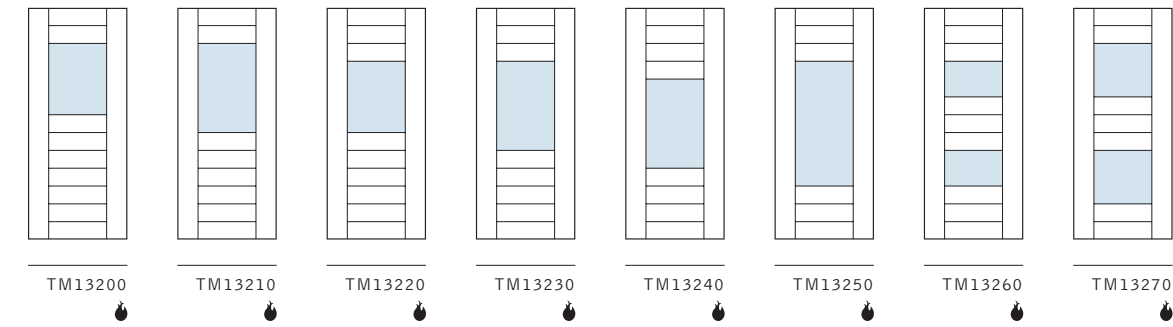
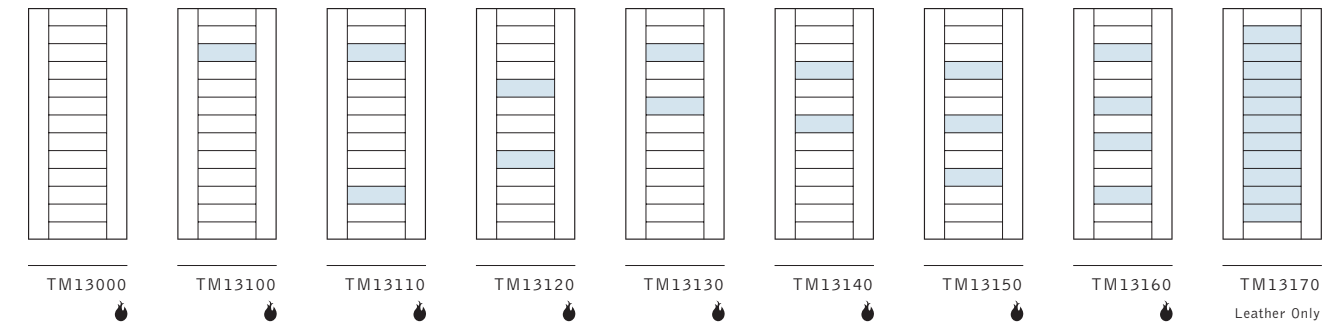

Note: Door styles are shown with the new modern wide stile. Shaded panels indicate an insert option: leather, metal, glass, resin or a flat wood panel.

Available as a fire-rated door*
 Radius-top option available
 Bi-fold closet option available
 Arch-top option available
 Common arch pair option available
 Available in MDF only
 *Contact TruStile to confirm exact fire ratings and available sizes

Available as a fire-rated door*
 Radius-top option available
 Bi-fold closet option available
 Arch-top option available
 Common arch pair option available
 Available in MDF only
 *Contact TruStile to confirm exact fire ratings and available sizes



TMIR6080 in mahogany with Espresso stain and 1/2" bright stainless steel inlay

TMIR Collection

Modern architecture demands exacting specifications. The Tru&Modern

Infinite Rail brings a luxurious level of sophistication with kerf cuts or metal inlays that traverse the complete width of the door.



TMIR6000 in walnut with Nutmeg stain and 1/4" kerf cut reveal

TMIR Series Door Styles

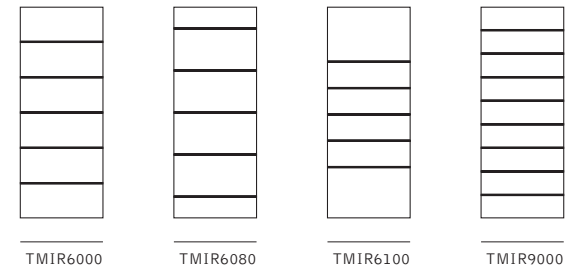
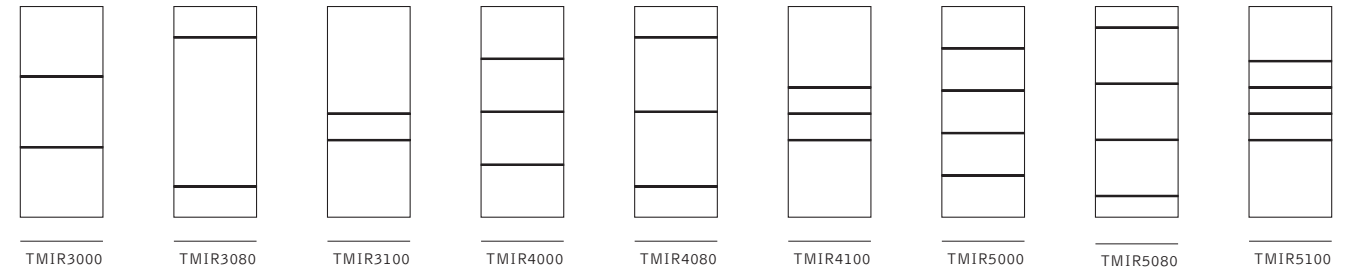

TMIR Series Profiles

TMIR Infinite Rail doors are available with the following profiles:

1/4" Kerf Cut Reveal

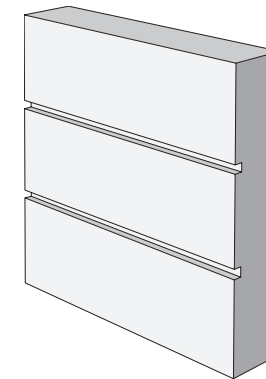

1/2" Stainless Steel Inlay

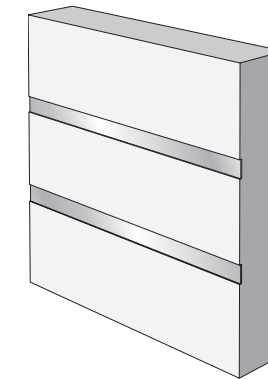

Available with bright or brushed stainless steel



FL300 in MDF with Bevel glass

FL Door Collection

Our French Door (FL) Collection offers 100 classic glass door designs from one- to 18-lite configurations. Our French Doors are crafted with true divided lites. Each individual piece of glass is hand-inserted for maximum architectural detail.



FL840 in Cherry with Groove glass

FL Series Door Styles

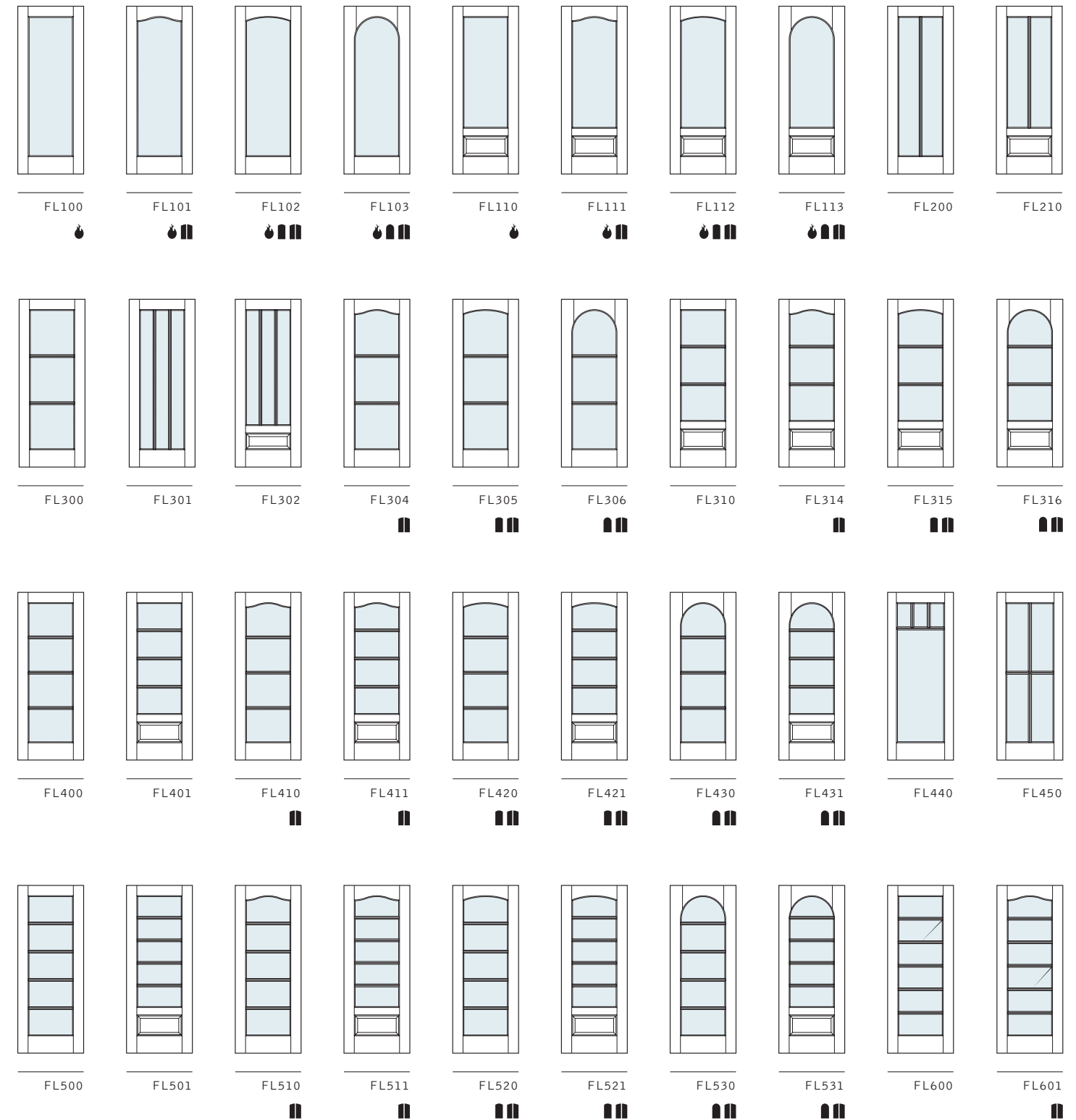

Available TruStyle Product Options	<ul style="list-style-type: none"> Available as a fire-rated door* Arch-top option available 	<ul style="list-style-type: none"> Radius-top option available Common arch pair option available 	<ul style="list-style-type: none"> Bi-fold closet option available Available in MDF only
------------------------------------	--	--	--

*Contact TruStyle to confirm exact fire ratings and available sizes

FL Series Door Styles

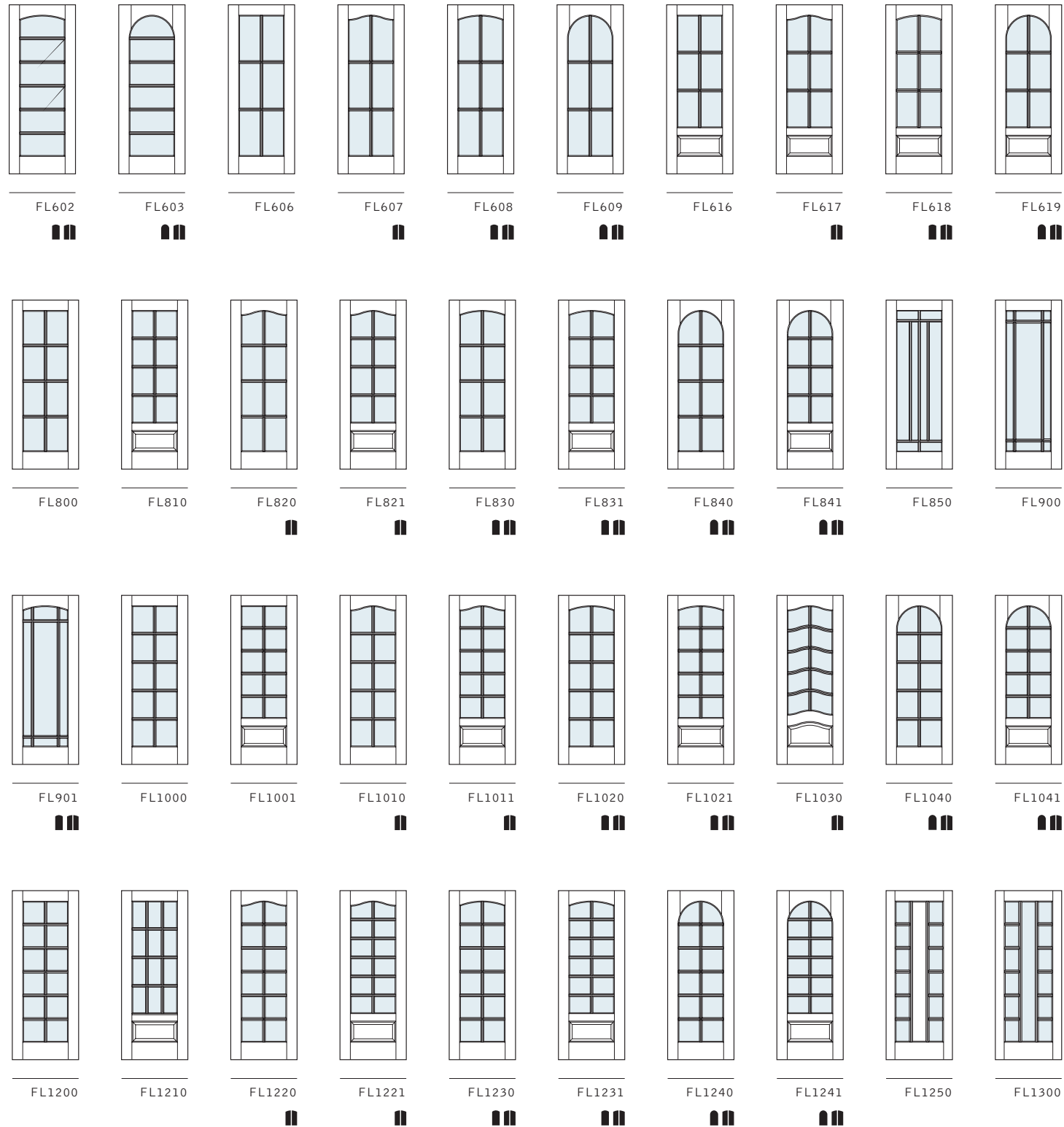

Available TruStile Product Options
 Available as a fire-rated door*
 Arch-top option available
 Radius-top option available
 Common arch pair option available
 Bi-fold closet option available
 Available in MDF only
 *Contact TruStile to confirm exact fire ratings and available sizes

FL Series Door Styles

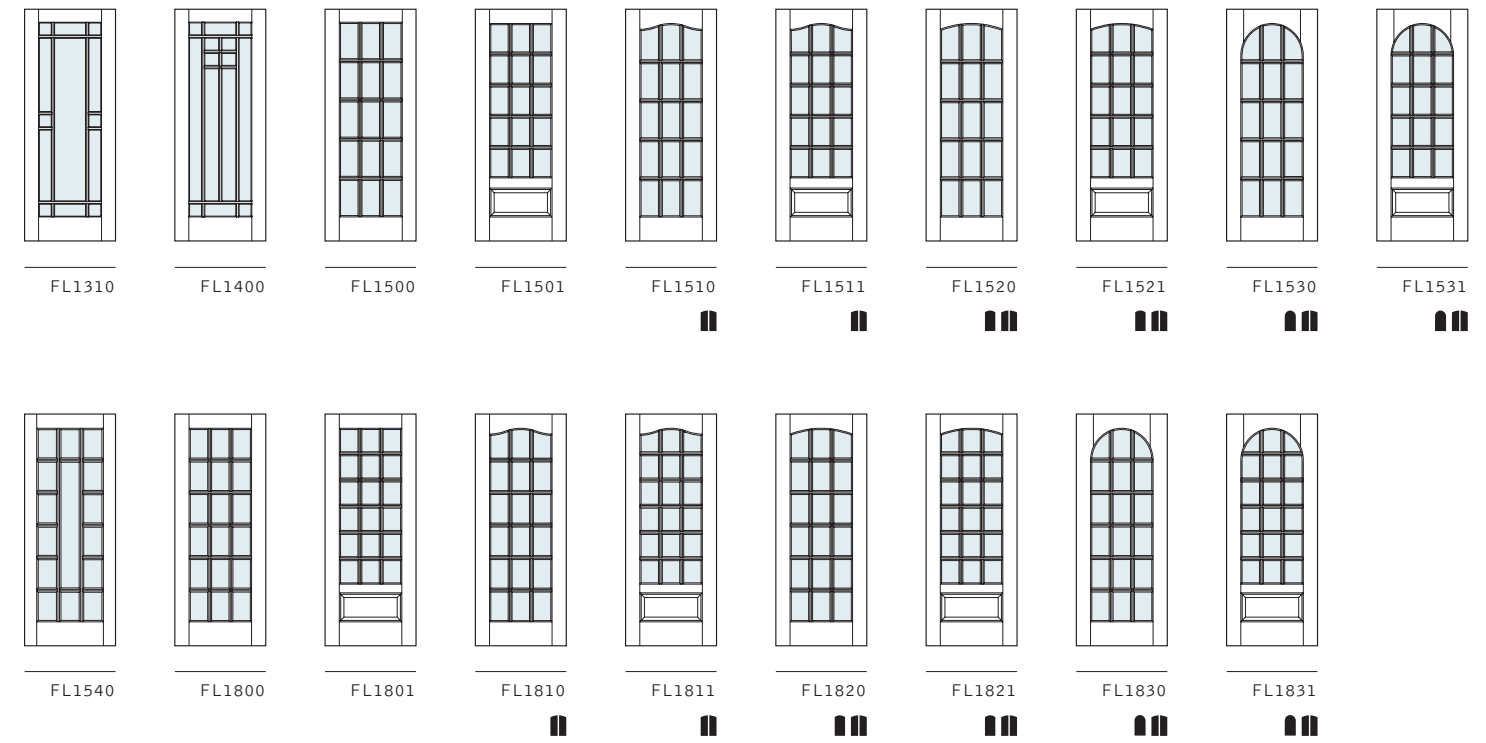

Available TruStile Product Options
 Available as a fire-rated door*
 Arch-top option available
 Radius-top option available
 Common arch pair option available
 Bi-fold closet option available
 Available in MDF only
 *Contact TruStile to confirm exact fire ratings and available sizes



PL Door Collection

Our Panel Lite (PL) Door Collection combines raised panels with glass lites, giving you the best of both styles. A popular selection for pantries, bathrooms and entries, panel lite doors can be used for both interior and exterior applications.



PL Series Door Styles



- Available TruStile Product Options
 - Available as a fire-rated door*
 - Arch-top option available
 - Radius-top option available
 - Common arch pair option available
 - Bi-fold closet option available
 - Available in MDF only
- *Contact TruStile to confirm exact fire ratings and available sizes

PL Series Door Styles



Glass Door Profile Options

The following sash and compression fit options are available to match our panel door profiles.

Glass Door Profile Options

Reverse Roman Ogee (OG) Sash

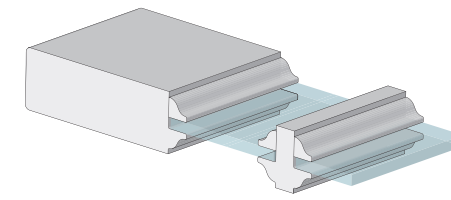

Narrow Reverse Roman Ogee (OG) Sash*

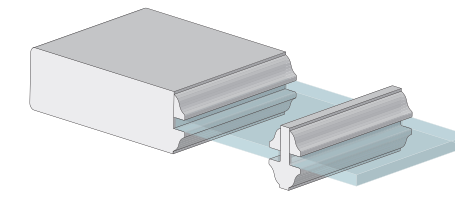

Cove & Bead (CB) Sash

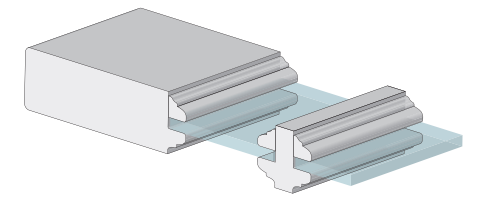

Quarter Bead (QB) Sash

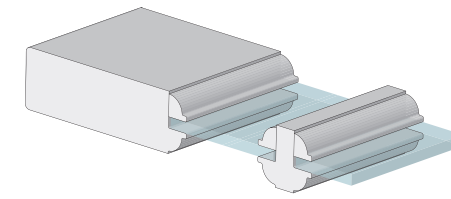

Quarter Round (QR) Sash

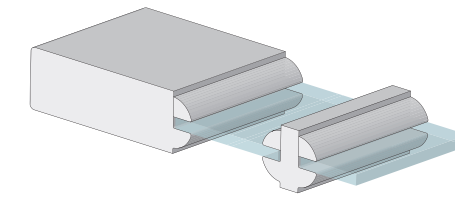

Bevel (BV) Sash

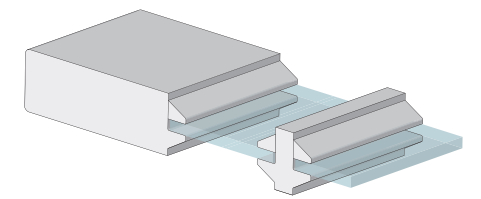

Square Stick (SS) Sash

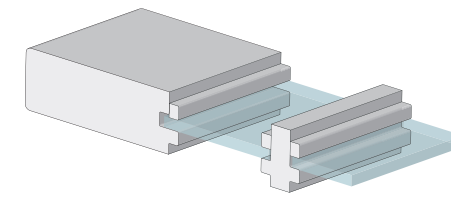

Square Stick (SS) Compression Fit**

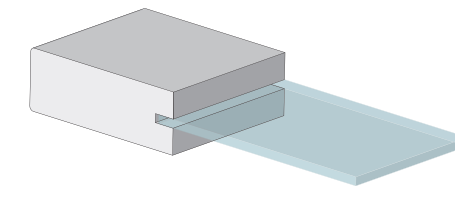

Quirk Moulding (QM) Compression Fit**

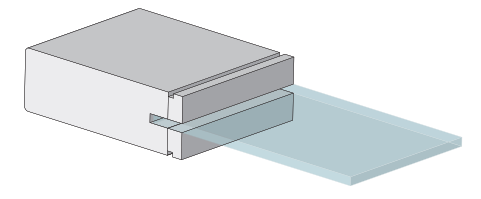

One Step (OS) Sash

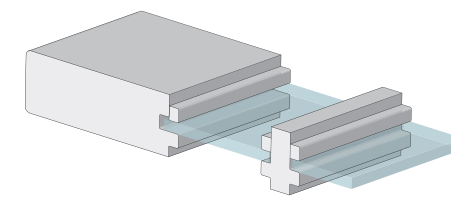

Applied Raised Moulding (ARM)

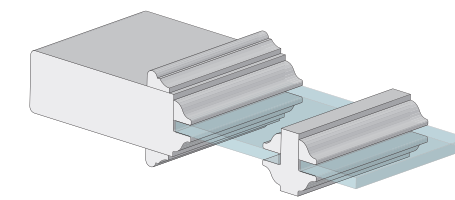

- Available TruStile Product Options
 - Available as a fire-rated door*
 - Radius-top option available
 - Bi-fold closet option available
 - Arch-top option available
 - Common arch pair option available
 - Available in MDF only
- *Contact TruStile to confirm exact fire ratings and available sizes

* Optional 3/8" narrow muntin bars available only on interior doors with 1/4" glass.
 ** On compression fit doors, glass cannot be replaced if broken.

V-Groove Door Collection

Our V-Groove (VG) Door Collection features a tongue-and-groove look that emulates plank doors. Each door is built with genuine stile and rail construction to ensure greater performance than plank doors.

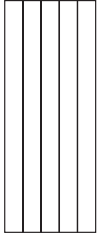
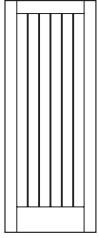
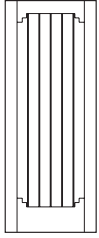
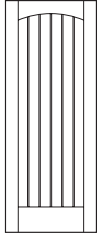
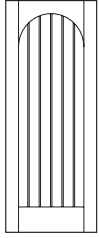
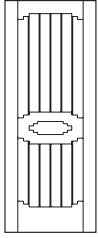
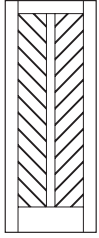
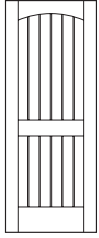
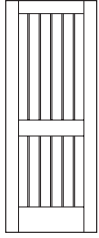
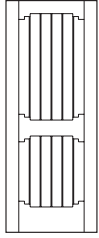
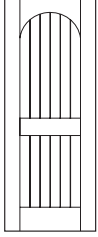
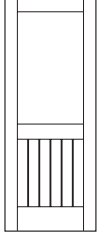
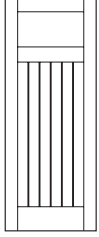
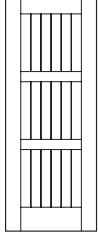
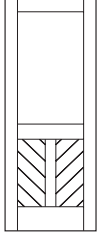
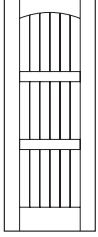
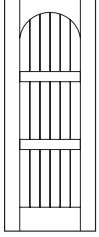
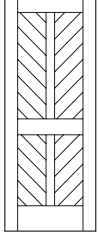
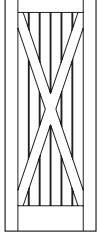
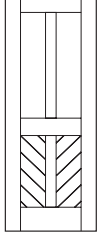
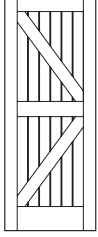
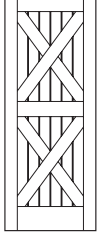
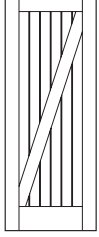
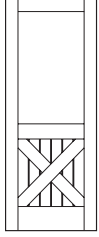
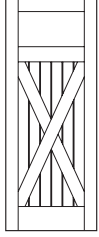

VG Series Door Styles

 VG1000 ☹️	 VG1010 🔥	 VG1020 🔥	 VG1030 🔥	 VG1040 🔥	 VG2000 🔥	 VG2010 🔥	 VG2020 🔥	 VG2030 🔥	 VG2040 🔥
 VG2070 🔥	 VG2100 🔥	 VG2150 🔥	 VG3000 🔥	 VG3010 🔥	 VG3020 🔥	 VG3030 🔥	 VG4000 🔥	 VG4010 🔥	 VG4020 🔥
 VG4030 🔥	 VG4040 🔥	 VG4050 🔥	 VG4100 🔥	 VG4150 🔥					

Plank Door Profiles (VG1000)

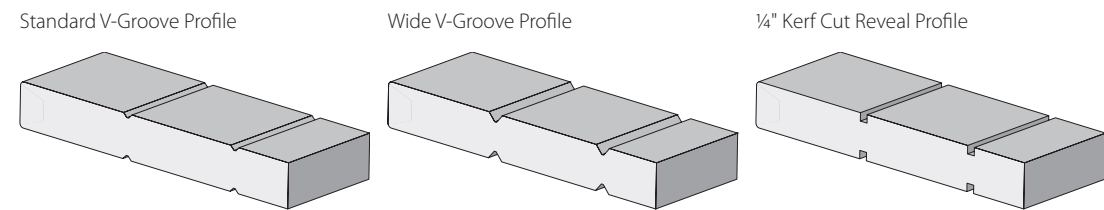

Plank doors are available with standard and wide plank spacing and the following profiles:

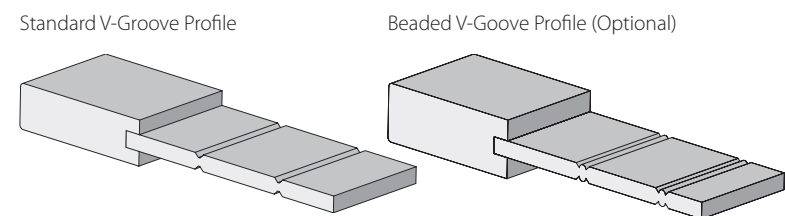

V-Groove Series Profiles

V-Groove doors come with one of the following standard profiles:



 Available TruStile Product Options
  Available as a fire-rated door*
  Radius-top option available
  Bi-fold closet option available
  Arch-top option available
  Common arch pair option available
  Available in MDF only

*Contact TruStile to confirm exact fire ratings and available sizes



Tambour Door Collection

Our Tambour (TMB) Door Collection combines stile and rail construction with state-of-the-art CNC routing technology to create a uniquely contemporary look.

Combine these doors with other styles for design interest and visual variety.

TMB Series Door Styles

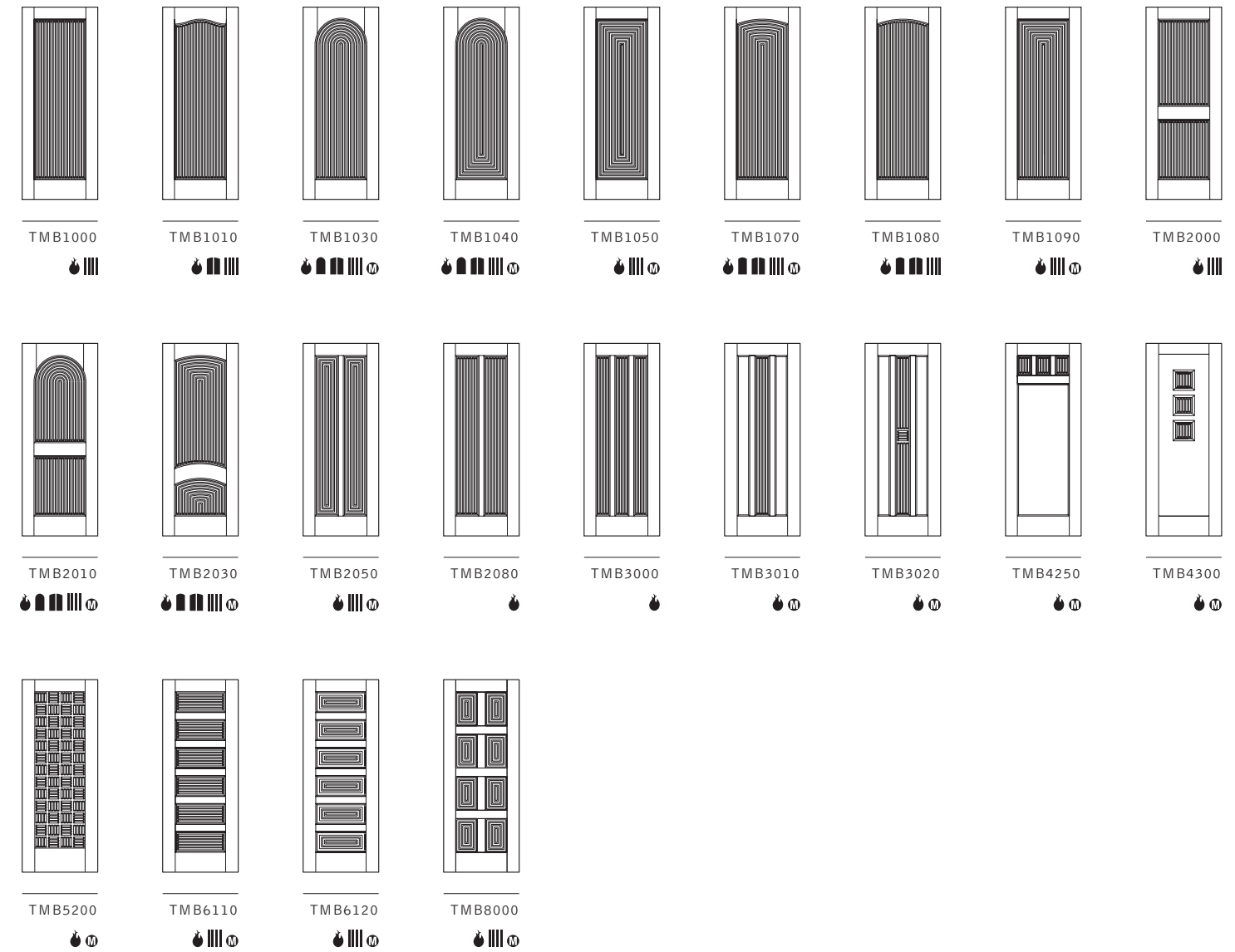

Tambour Door Profile Options

Choose from Half-round and Bevel profile options for Tambour doors in MDF. Half-round is our standard profile for Tambour wood doors.

Half-round

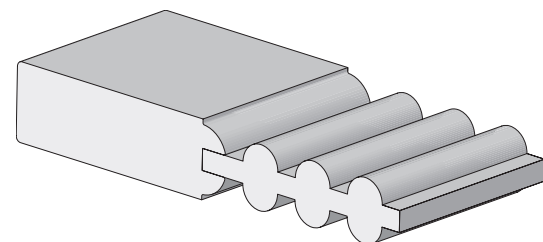

Bevel (MDF Only)

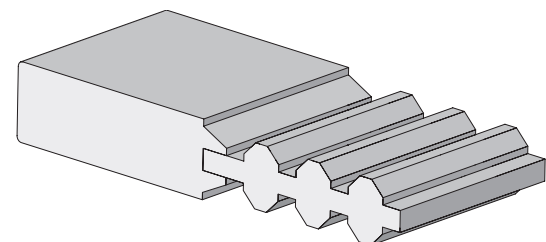

- Available TruStile Product Options
- Available as a fire-rated door*
- Arch-top option available
- Radius-top option available
- Common arch pair option available
- Bi-fold closet option available
- Available in MDF only

*Contact TruStile to confirm exact fire ratings and available sizes

Custom Design Door Collection

Our Custom Design (CD) Collection features an eclectic mix of custom styles from our design team. These exclusive TruStile designs fulfill a variety of architectural styles and are perfect for creating a dramatic visual impact. TruStile's Custom Design Collection proves that doors can be just as exciting as other home design elements.



AD3030 in MDF and White Lami glass with custom star-shaped plant-ons

CD Series Door Styles

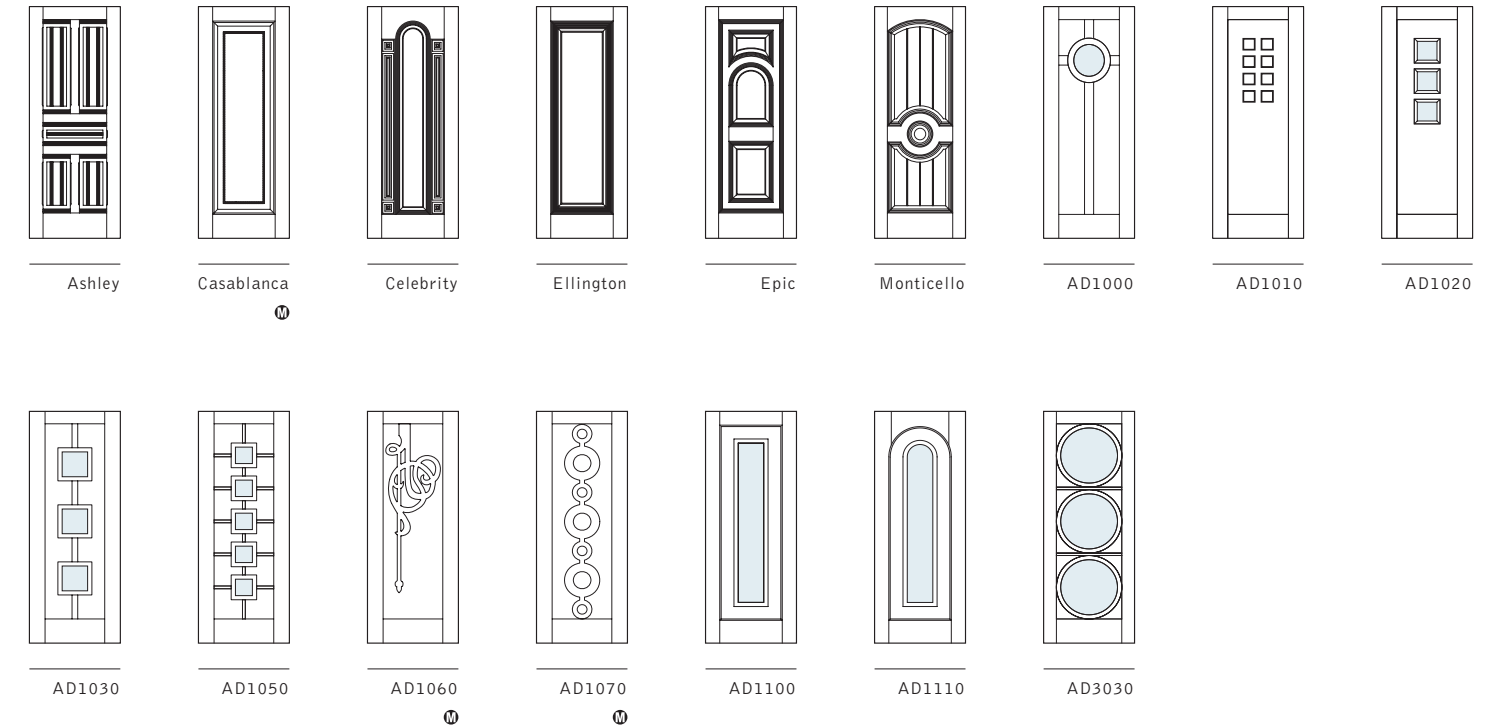

Available in MDF only



LVR2020 in MDF

Louver Door Collection

Our Louver (LVR) Door Collection creates architectural interest and enhances a variety of styles. These plantation-style louver doors feature fixed, over-sized louvers in vented and false configurations.

Vented Louver Doors

Vented louver doors permit air flow making them ideal for closets and laundry rooms where ventilation is preferred.

False Louver Doors

False louver doors are ideal for applications where a louver look is desired, but total privacy is a necessity.

LVR Series Door Styles

Vented Louver

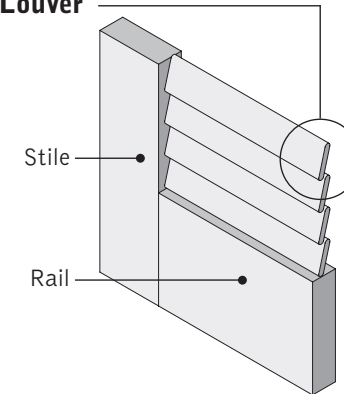

False Louver

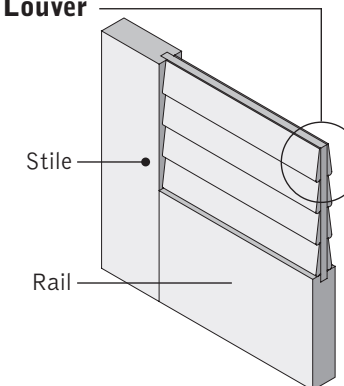

Visible Louver Dimensions

Vented: 2"
False: 2"

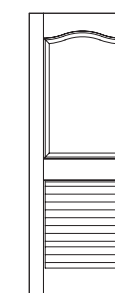
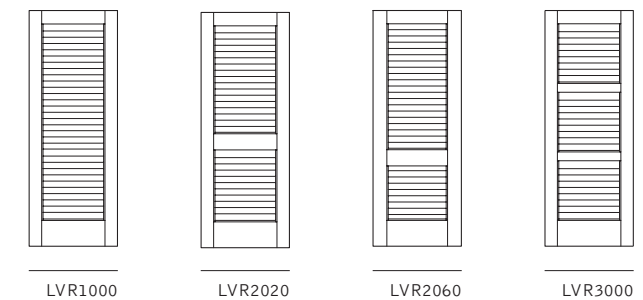

Example of TS2040 with bottom panel replaced with a louver panel.

Our TruCAD®
Door Design Tool
Allows Complete
Customization

With TruStile's exclusive web-based software, you can design your own custom door. Specify the height, width and location of all the stiles, rails and mullions within a door. Make your door your own at www.trustile.com.

TM9420 in MDF with
Satin Barcode glass
(custom horizontal glass
pattern direction)

Customize your door size, and select options from the "Main" tab

TRUSTILE
DRIVEN BY DESIGN™

Print or Save PDF Export DXF Reset Door Image Feedback or Questions Where to Buy

Main Parts

Door Style: VG2020

Opening Type: Single

Door Top: Arch Top

Door Grade: Interior

Panel Substitution: None

Material & Fire Rating

Material: MDF

Fire Rating: Non-rated

Dimensions

Gross Width (In): 36

Pre-Fit Width: None

Gross Width (In): 36

Height (In): 96

Thickness: 1-3/4

Profiles

Sticking: SS-Square Stick

Panel: C-Flat

Groove Type: Standard V-Groove

Construction

LVL Stiles: Yes

Primed:

View Options

Display Dimensions:

Technical drawing showing dimensions: 36" width, 96" height, 5" top rail, 5 1/2" lock rail, 3 31/64" arch drop, 24 1/2" bottom panel, 8 3/4" bottom panel, 1-3/4" LVL Stile, 11/16" detail.

TRUSTILE
DRIVEN BY DESIGN™

Main Parts

Parts

Left Stile (Default: 4-1/2): 5

Right Stile (Default: 4-1/2): 5

Top Rail Height (Default: 4 1/2): 5

Door Arch Top Drop (Default: 3 31/64): 3 31/64

Lock Rail Height (Default: 5 1/2): 5 1/2

Lock Rail Centerline from Bottom of Door (Default: 36): 36

Bottom Panel Height: 8 3/4

Customize individual components from the "Parts" tab

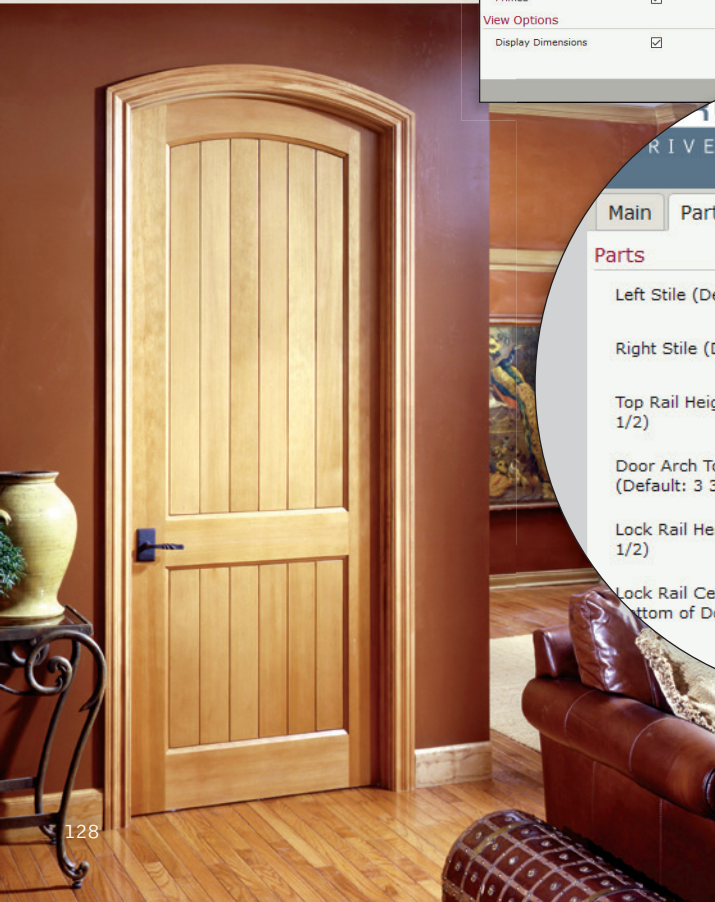



FOLLOW US



www.trustile.com

Front Cover: VG4010 barn door in wire-brushed white oak and TS4240 door in MDF and White Lami glass.

Back Cover: TM13340 in walnut with 1/4" kerf cut reveal and White Lami glass.



Full Line Architectural Catalog 03/14 © 2018 TruStile Doors, LLC. ® and ™ are trademarks of TruStile Doors, LLC. Select hardware provided by Emtek Products, Hafele America and Rocky Mountain Hardware.

TRUSTILE DOORS, LLC

1780 East 66th Avenue
Denver, CO 80229
888.286.3931