

# MiTek®

## USP® PRODUCT CATALOG



59<sup>TH</sup> EDITION-2019

# SPECS. JUST A CLICK AWAY. DOWNLOAD THE ONLINE CATALOG & APP

## Hangers

### KB / KLB Beam & Purlin Hangers

With a top mount design and heavy steel fabrication the KB and KLB hangers can cover medium-to-heavy beam and purlin applications. The top mount design offers high loads with less raftering than comparable face mount hangers.

KLB - 14 gauge.  
KB - 12 gauge.

Materials: See chart  
Finish: G90 galvanizing  
Codes: See page 12 for Code Reference Chart

#### Installation:

- Use all specified fasteners. See Product Notes, page 20.
- NA201D nails are included with hangers where applicable.
- For welded installations, see page 287.
- KB models are not recommended for use with LVL, PSL, or LSL members.

### HDO Heavy-Duty Top Mount Hangers

Primarily used to hang joists or headers in medium load conditions. These hangers provide higher load values with less raftering.

Materials: 12 gauge  
Finish: G90 galvanizing

MiTek



Typical KB installation



Typical KLB installation



HDO standard installation



- Easy navigation to search structural connector products in this catalog
- Access product applications, instructions, fastening schedules and load ratings and reference numbers
- Cross reference product specifications and look up on the fly
- Email pages from the app on any mobile device

FREE DOWNLOAD



## MITEK USP ONLINE CATALOG

### ALWAYS AVAILABLE AND UP TO DATE

View digital version of the printed catalog at [MiTek-US.com/resources/product-catalog](http://MiTek-US.com/resources/product-catalog). Bookmark it for the most current technical information.

Use the [Advanced Product Search function](#) on the home page to find detailed information on any MiTek USP product. Simply enter the product name, SKU number or reference number.



## MiTek® IHFL (18GA) /IHF (16GA) Series Face Mount I-Joist Hangers

These hangers feature speed prongs for temporary placement and seat cleats to grab the bottom flange of the supported I-joist. Diamond holes in header and joist allow for optional Max nailing for customized fastening to match allowable load needed, saving you time and money on the jobsite. See page 185 for details.



## MiTek® Mechanical Anchors

Coming Soon! A new line of Wedge Anchors, Sleeve, Hammer Nail, Drop In Anchors and Wedge Bolts, Concrete Screws, Rod Hangers, and accessories – offering superior loads, and ICC approval for use in cracked concrete. More information will be on our website at [MiTek-US.com](http://MiTek-US.com).



## M&M™ HVAC Duct Systems

High-efficient solutions from the country's largest producers of sheet metal products in the air distribution and ventilation market for residential and commercial construction. Visit [mmmfg.com](http://mmmfg.com) for more details.



## Snappy™ HVAC Pipe and Fittings

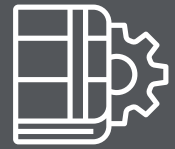
Providing innovative and increasingly efficient HVAC Comfort Distribution Products as the nation's leading supplier of galvanized pipe & fittings for the residential HVAC Industry. For more information visit [snappyco.com](http://snappyco.com).



# MITEK INTEGRATED SOLUTIONS

## SERVICES

MiTek® provides a range of services to support the efficient growth, capability, and profitability of our customers. The MiTek Services Division allows our customers to improve their scalability without adding overhead. Our software consulting and implementation team enables effective transformation to high-performance processes.



## SOFTWARE

MiTek's Enterprise Software systems optimize the business workflow, including the costing, design, and production of homes. Our SAPPHIRE® 3D Structural Modeling Software also expands the capability of every 2D or 3D architectural software platform — by creating an optimized, buildable, structural frame in a virtual world.



MiTek

## SERVICES

### MiTek Engineering Services™

Utilize expert, customized Drafting and Design Services, using structural design software, to guide construction projects from concept to completion. Since 1990.

### Wrightsoft HVAC™ Design Services

Create an HVAC system designed to optimize the home's comfort, efficiency, and indoor air quality, utilizing Wrightsoft's Production Home Design Services.

### Consulting and Implementation Services

Our roadmap, transition and optimization processes enable your teams to transition effectively to our higher-performance software platforms, and maximize your business productivity.

## SOFTWARE

### SAPPHIRE® Build for Home Builders

Optimize operational workflow utilizing this cloud-based, enterprise management suite for builders. Manage all aspects of your business for: marketing, sales, construction operations, product development and customer relationship management.

### SAPPHIRE® Supply for LBM Suppliers

MiTek's SAPPHIRE® Supply is the one stop shop solution for whole-house estimating, framing layout and design. Maximize your productivity and eliminate the guesswork. It's time to digitize the supply chain.

### SAPPHIRE® Structure for Component Manufacturers

SAPPHIRE® Structure delivers powerful structural modeling, editing, and estimating functionality. Gain more efficiency, productivity and more focus on the design process with software that works the way you work.

### MiTek® Builder MT / Sales Simplicity / Options Online™

Best in class enterprise software for residential home builders and their trades. The most award winning technology in home building.

### MiTek® BMT Cloud™ (Coming in 2019)

Leverage the same industry proven platform that underpins BuilderMT, and MiTek's SAPPHIRE® Build, which powers some of the largest-volume home builders today.

### Cubit Estimating Software

Suited to estimators, surveyors, builders and contractors, Cubit delivers a unique and natural solution for estimating your building and construction projects.

### Wrightsoft Right-Suite®

A powerful, fully-integrated residential and commercial 2D/3D CAD solution for HVAC Design and Sales.

# INTEGRATED SOLUTIONS FOR MORE AFFORDABLE, SUSTAINABLE, SAFE, HEALTHY, EFFICIENT AND RESILIENT HOMES.

## OFF-SITE MANUFACTURING

Conquer the labor shortage. Off-site design, prefabrication technology reduces cycle times and offers predictable costs, resulting in higher throughput for you, and consistent, high-quality homes for your customers.

## ENGINEERED STRUCTURAL CONNECTIONS

With constant R&D and new products developed every year, MiTek® has crafted thousands of code-compliant engineered solutions that waste less time, material, labor, steps and costs. Since 1955, our solutions have been built on a tradition of innovation and improving customer performance in everything we do.

## ENGINEERED STRUCTURAL CONNECTIONS

### MiTek® Hardy Frame® Lateral Load Solutions

The only complete line of lateral force resisting products for residential homes – from single family to multi-story, multifamily complexes.

### MiTek® ProSeries® Fasteners

Increase jobsite speed and quality with better performing, structural fasteners. Code compliant. Pro quality. Reduces labor.

### OZCO™ Ornamental Wood Ties

The industry's leading decorative hardware includes the broadest offering in the market – 81 SKUs earmarked by 9 patents.

### USP® Structural Connectors

A complete line of innovative code-compliant construction hardware backed by robust design and placement software, training and technical support.

### M&M™ HVAC Duct Systems

High-efficient solutions from the country's largest producers of sheet metal products in the air distribution and ventilation market.

### MiTek® Anchoring Solutions

Utilize a complete line of high performance epoxies and mechanical anchors for a range of residential applications.

### Z4™ Tie-Down Systems

Save cost, installation and production time with the most economical, uniquely self-adjusting system in the industry to resist wind uplift and seismic forces.

### H&B™ Moisture Barrier Solutions

From foundation barriers to flashings, rely on a superior and complete line of defense against damage caused by moisture.

## OFF-SITE MANUFACTURING

### Roof Trusses

Accelerate cycle times, increase margin, and employ faster, high-quality construction with reduced dependency on framing labor. All-in costs to builders are more competitive and better-controlled than ever.

### Prefabricated Walls

Reduce installation time and all-in cost with precision-designed, precision-produced, code-compliant structural framed assemblies. Components can be produced for even the most custom of homes.

### Floor Trusses

Floor trusses offer an engineered, faster installation, pre-designed floor system with plenty of room for mechanicals. Significantly reduce framing time and eliminate red tags and back-charges.



## Add Beauty and Strength to Outdoor Wood Projects with Ornamental Wood Ties

- Use for Pergolas, pavilions, backyard projects
- Stocked in two styles: Ironwood and Sunset Laredo
- Sold in kits for complete installation
- Galvanized and powder coated for durability
- Structural and load rated for safety
- Patented Timber Bolts are for any application requiring bolts
- Many products are adjustable which limits the number of SKUs in inventory
- Many proprietary products including Timber Bolts, Post Bands and Rafter Seams
- Check out OWT Lite for a more economical option



### MiTek® OZCO Project Explorer App

Free App for iPhone and iPad

The NEW MiTek® OZCO Project Explorer app lets you explore projects for building a variety of pergolas, pavilions, and backyard projects. The app features over 25 projects with materials, cut lists, and part lists included. Engage your customers in a more efficient design process to increase your outdoor project sales.

#### Learn More:

[MiTek-US.com/products/Ornamental-Wood-Ties](http://MiTek-US.com/products/Ornamental-Wood-Ties)

- Code Evaluation Information . . . . . 12
- Corrosion Information . . . . . 13-18
- Design Notes . . . . . 20-21
- Installation Notes . . . . . 21
- New Products . . . . . 3-6
- Product Information . . . . . 19
- Product Notes . . . . . 20
- Reference Number Index . . . . . 10-11
- MiTek index . . . . . 8-9

## Angles & Straps . . . . . 98-121

- Angles . . . . . 98-100, 101-102, 107-108
- Clips . . . . . 100, 105
- Header Hangers . . . . . 105
- Knee Braces . . . . . 121
- Lateral Joist Connectors . . . . . 106
- Ornamental Connectors . . . . . 110
- Straps . . . . . 109-121
- Stud Plate Ties . . . . . 103-104

## Caps & Bases . . . . . 77-97

- Column Bases . . . . . 83-86
- Column Caps . . . . . 81-97
- Post Anchors . . . . . 78-80, 87
- Post Bases . . . . . 77, 81-82, 91
- Post Caps . . . . . 88-91

## Concrete & Masonry . . . . . 41-61

- Anchor Bolts . . . . . 47-49
- Anchor Rod Chairs . . . . . 46
- Anchoring Epoxy . . . . . 41-42
- Beam Seats . . . . . 60
- Bearing Plates . . . . . 49
- Concrete Form Ties & Wedge . . . . . 52
- Coupler Nuts . . . . . 51
- Foundation Anchors . . . . . 53-59
- Hangers . . . . . 61
- Hex Nuts . . . . . 52
- Mechanical Anchors . . . . . 43-45
- Retro Plates . . . . . 59
- Threaded Rods . . . . . 46, 50
- Washers . . . . . 51

## Deck & Fences . . . . . 266-272

- Angles . . . . . 269
- Deck Connectors . . . . . 266-267, 269
- Fence Hardware . . . . . 270-272
- Stair Angles . . . . . 268

## EWP Hangers . . . . . 181-209

- Adjustable Connectors . . . . . 208
- EWP Hanger Selector Guide . . . . . 181
- EWP Installation . . . . . 182-183
- Face Mount Hangers . . . . . 184-194
- Top Mount Hangers . . . . . 195-207
- Slope/Skew Hangers . . . . . 209

## Fasteners . . . . . 22-40

- Bolts . . . . . 26
- Nails . . . . . 22-25
- Screws . . . . . 27-40

## General Hardware . . . . . 273-282

- Bridging . . . . . 278-279
- Corner Tie . . . . . 281
- D.I.Y. Products . . . . . 274
- Drywall Clip . . . . . 273
- Insulation Supports . . . . . 273
- Mending Plates . . . . . 282
- Nail Plates . . . . . 282
- Plywood Clips . . . . . 273
- Protection Plates . . . . . 275
- Shelf Brackets . . . . . 281
- Straps . . . . . 276-277
- Stud Shoes . . . . . 277
- Wall Bracing . . . . . 280
- Wall Ties . . . . . 281

## Glulam Beam Connectors . . . . . 210-218

- Face Mount Hangers . . . . . 210-212
- Hinge Connectors . . . . . 216-217
- Seismic Straps . . . . . 217
- Top Mount Hangers . . . . . 213-215, 218

## Hangers . . . . . 122-180

- Face Mount Hangers . . . . . 123-154
- Hanger Selection Guide . . . . . 122

- Masonry Hangers . . . . . 173-180
- Panel & Purlin Hangers . . . . . 168-172
- Slope/Skew Hangers . . . . . 164-167
- Strap Hangers . . . . . 163
- Top Mount Hangers . . . . . 154-162
- Wall Ties . . . . . 172

## Holdowns . . . . . 62-76

- Concrete Angles . . . . . 76
- Foundation Straps . . . . . 69-73
- Holdowns . . . . . 62, 65-68
- Purlin Anchors . . . . . 74-75
- Tension Ties . . . . . 63-64

## Lateral Systems . . . . . 288-290

## Plated Truss . . . . . 238-265

- Alternate Installations . . . . . 257
- Blocking Supports . . . . . 264
- Drag Strut Connectors . . . . . 252
- Face Mount Hangers . . . . . 238-242
- Field Splice Kits . . . . . 265
- Girder Hangers . . . . . 253-256
- Hip/Jack Connectors . . . . . 251-252
- Hoist Plates . . . . . 264
- Skewed Nail Plate . . . . . 250
- Spacers/Braces . . . . . 258-259
- Strap Hangers . . . . . 243-249
- Supplementary Bearing Plates . . . . . 260
- Truss Clips . . . . . 261-264

## Specialty Options . . . . . 283-287

- Face Mount Hanger . . . . . 284
- Open Top Flange Hanger . . . . . 285
- Solid Top Flange Hanger . . . . . 285-286
- Welded Top Flange Hanger . . . . . 287

## Truss & Rafter . . . . . 219-237

- Angles . . . . . 230-231
- Girder Tiedowns . . . . . 226-229, 232-233
- Hurricane Ties . . . . . 231, 234-236
- Moisture Barrier Plates . . . . . 219
- Strap Connector . . . . . 237
- Truss Anchors . . . . . 219-225

Copyright © 2019 MiTek Industries, Inc. All Rights Reserved

### WARRANTY

MiTek USA, Inc. ("MiTek") warrants its MiTek catalog Products to be free from material defects in manufacture and design, and further warrants that they will perform within the design limitations of its published building code approvals for the applications described, when properly installed and maintained. These warranties do not cover Product deterioration due to environmental conditions, Products that have been modified or damaged, improperly installed or used outside of published design limitations or for other applications. In the event any Product is shown to not conform to these warranties, MiTek's sole obligation, and Customer's sole and exclusive remedy, shall be, at MiTek's option, to replace the non-conforming product or refund the full purchase price paid by Customer to MiTek therefor. MITEK MAKES NO OTHER PRODUCT WARRANTIES,

EXPRESS OR IMPLIED, OF ANY KIND, AND PARTICULARLY EXCLUDES ANY IMPLIED WARRANTY OR MERCHANTABILITY OR FITNESS FOR A PARTICULAR PURPOSE. IN NO EVENT SHALL MITEK BE LIABLE FOR INCIDENTAL, CONSEQUENTIAL OR SPECIAL DAMAGES, REGARDLESS OF THE LEGAL THEORY OF RECOVERY, EVEN IF IT WAS AWARE OF THE POSSIBILITY OF SUCH DAMAGES. IN ANY CASE, MITEK'S MAXIMUM LIABILITY SHALL NOT EXCEED THE PURCHASE PRICE PAID BY CUSTOMER FOR THE NON-CONFORMING PRODUCT. Some states restrict consequential or other liability damage limitations, so some of the above limitations may not apply to you. MiTek reserves the right to change this warranty periodically. Consult MiTek's website MiTek-US.com or contact MiTek for a current warranty statement.

**A** A Angle Clip . . . . .98-99  
**AB** Anchor Bolts . . . . .49  
**AC** Angle Clips . . . . .98-99  
**ADTT** Adj. Deck Tension Tie . . . . .151, 266  
**Alternate Installations** . . . . .257  
**ANJ** Heavy Angles . . . . .107  
**ARC** Anchor Rod Chairs . . . . .46  
**ATR** All Thread Rod . . . . .50

**B** B Bolts . . . . .26  
**B** Corner Braces . . . . .108  
**BC** Post Cap . . . . .89  
**BCS** Post Caps . . . . .89  
**BD** Bolt Down . . . . .272  
**BL** Corner Braces . . . . .108  
**BN** Breakfast Nook Hangers . . . . .252  
**BP** Bearing Plates . . . . .49  
**BPH** Beam & Purlin Hangers . . . . .196, 199, 201-207

**C** C Post Caps . . . . .89  
**CBE** Column Bases . . . . .85  
**CBSQ** Column Bases . . . . .86  
**CIA-GEL** Epoxy . . . . .41-42  
**CIA-EA** Epoxy Acrylate . . . . .42  
**CLPBF** Butterfly Hanger . . . . .238  
**CMST** Coiled Strapping . . . . .111  
**CMSTC** Coiled Strapping . . . . .111  
**CNW** Coupler Nuts . . . . .51  
**CPB** Composite Post Bases . . . . .91  
**CSH** Concealed Stringer Hanger . . . . .154, 267

**D** D Post Anchors . . . . .87  
**DC** Drywall Clip . . . . .273  
**DC** Deck Clip . . . . .269  
**DHTA** Truss Anchors . . . . .223  
**DSC** Drag Strut Connectors . . . . .252  
**DTB** Deck Tie Back . . . . .62, 152, 267  
**DTC** Truss Anchor . . . . .224  
**DTUS** Undersaddle Hanger . . . . .171  
**DUC** Ductile Undercut Anchors . . . . .43

**E** EA Adhesive (CIA-EA) . . . . .42  
**EBG** Elevated Post Base . . . . .82  
**EPB** Elevated Post Bases . . . . .81-82  
**EPBH** Elevated Post Bases . . . . .82  
**EPCM** End Post Caps . . . . .88  
**ERB** Fence Bracket . . . . .153, 271  
**EWP** Hanger Selector Guide . . . . .181  
**EWP** Installation . . . . .182-183

**F** FA Foundation Anchors . . . . .53-54  
**FB** Fence Brackets . . . . .153, 271  
**FHD** Panel Hanger . . . . .172  
**FRB** Fence Brackets . . . . .153, 271  
**FS** Truss Field Splice Kits . . . . .265  
**FSS** Truss Field Splice Kits . . . . .265  
**FT** Concrete Form Ties . . . . .52  
**FTC** Floor Truss Clips . . . . .261  
**FTCF** Floor Truss Clips . . . . .261  
**FWAN** Foundation Wall Anchor . . . . .56  
**FWH** Fire Wall Hangers . . . . .160-161

**FWHBP** Fire Wall Hangers Beam Purlin . . . . .162  
**FWHFM** Face Mount Fire Wall Hangers . . . . .150

**G** **GEL Epoxy** (CIA-GEL Series) . . . . .41-42  
**GHF** Glulam Face Mount Hangers . . . . .211-212  
**GT** Girder Truss Hangers . . . . .255-256  
**GTD** Girder Truss Hangers . . . . .255-256  
**GTQ/GTQM** Girder Truss Hangers . . . . .254  
**GTS** Girder Truss Hangers . . . . .255-256  
**GTWS** Girder Truss Hangers . . . . .253

**H** **Hanger Selector Guide** . . . . .122  
**Hardy Frame® Moment Frames** . . . . .288  
**Hardy Frame® Shear Wall Systems** . . . . .289  
**HBPH** Top Mount Hangers . . . . .196, 201-207  
**HBPS** Bearing Plates . . . . .49  
**HC** Hurricane/Seismic Anchor . . . . .234-236  
**HCPRS** Hurricane/Seismic Anchors . . . . .234-236  
**HD** Face Mount Hangers . . . . .125-149, 173, 186, 191-194  
**HDO** Top Mount Hangers . . . . .155, 157-159  
**HDQIF** Inverted Flange Hangers . . . . .125, 128-136, 140-148, 187, 192-194  
**HFS** Straps . . . . .116, 276  
**HGA** Hurricane Gusset Angles . . . . .231  
**HGAM** Hurricane Gusset Angles . . . . .230  
**HGU** Girder Hanger . . . . .210  
**HGUM** Masonry Girder Hangers . . . . .174  
**HH** Header Hangers . . . . .105  
**HHC** Hip/Hip Connectors . . . . .251  
**HHCP** Hurricane/Seismic Anchors . . . . .234-236  
**HHTA** Truss Anchors . . . . .221-222  
**HJC** Hip/Jack Connectors . . . . .251  
**HJHC** Hip/Jack Connectors . . . . .251  
**HL** Light Gauge Purlin Hangers . . . . .154, 157  
**HLBH** Beam Hangers . . . . .197, 201-203, 205-207  
**HLPTA** Truss Anchor . . . . .220  
**HN** Hex Nuts . . . . .52  
**HPA** Purlin Anchors . . . . .74-75  
**HPAHD** Foundation Straps . . . . .69-70  
**HRS** Strap Ties . . . . .112-114  
**HTA/HTAR** Truss Anchors . . . . .221-222  
**HTC** Heavy Truss Clip . . . . .264  
**HTHJ** Hip/Jack Connectors . . . . .251  
**HTP** Strap Ties . . . . .112-114  
**HTT** Tension Ties . . . . .64  
**HTW** Twist Straps . . . . .117-118  
**HTWM** Twist Straps . . . . .120  
**HUGT** Girder Tiedowns . . . . .229, 233  
**HUS** Slant Nail Hangers . . . . .124, 126-129, . . . . .133-134, 138-141, 145-146, 187, 192, 238  
**HWUH** Top Flange Hangers . . . . .175-176

**I** **IB** Incredi-Bond® Epoxy . . . . .42  
**ICPL** Protection Plates . . . . .275  
**IHF** Face Mount Hangers . . . . .185, 189-191  
**IHFL** Face Mount Hangers . . . . .185, 189-191  
**IS** Insulation Supports . . . . .273

**J** **JA** Joist Angles . . . . .98-99  
**JDS** Purlin Hangers . . . . .170  
**JH** Multi-Purpose Joist Hangers . . . . .163

**JL** Face Mount Joist Hangers . . . . .123, 126-127, 138-139  
**JLIF** Inverted Flange Hangers . . . . .123, 126-127, 138-139  
**JNP** Mending Plates . . . . .282  
**JPF** Purlin Hangers . . . . .169  
**JUS** Slant Nail Joist Hangers . . . . .124, 126-134, 138-146

**K** **KB** Beam & Purlin Hangers . . . . .155, 158-159  
**KCB** Column Base . . . . .84  
**KCBQ** Column Bases . . . . .83  
**KCC** Column Caps . . . . .95-96  
**KCCC** Column Caps . . . . .97  
**KCCO** Column Caps . . . . .97  
**KCCOB** Column Caps . . . . .97  
**KCCT** Column Caps . . . . .97  
**KCCQC** Column Caps . . . . .94  
**KCCQO** Column Caps . . . . .94  
**KCCQOB** Column Caps . . . . .94  
**KCCQ** Column Caps . . . . .92-94  
**KCCQT** Column Caps . . . . .94  
**KECC** End Column Caps . . . . .95-96  
**KECCL** End Column Caps . . . . .97  
**KECCQL** End Column Caps . . . . .94  
**KECCQO** End Column Caps . . . . .94  
**KECCO** End Column Caps . . . . .97  
**KECCQ** End Column Caps . . . . .92-94  
**KEG** Glulam Beam Hangers . . . . .213  
**KEGQ** Glulam Beam Hangers . . . . .212  
**KF** Panel Hangers . . . . .168  
**KGB** Glulam Hangers . . . . .214  
**KGH** Floor Girder Hangers . . . . .61  
**KGLB** Laminated Beam Seats . . . . .60  
**KGLBT** Laminated Beam Seats . . . . .60  
**KGLS** Glulam Saddle Hangers . . . . .218  
**KGLST** Glulam Saddle Hangers . . . . .218  
**KGLT** Glulam Beam Hangers . . . . .215  
**KHC** Hinge Connectors . . . . .216-217  
**KHCCT** Hinge Connectors . . . . .216  
**KHCST/KHCSTR** Seismic Straps . . . . .217  
**KHCT** Hinge Connectors . . . . .216  
**KHGB** Glulam Hangers . . . . .214  
**KHGLB** Laminated Beam Seats . . . . .60  
**KHGLS** Glulam Saddle Hangers . . . . .218  
**KHGLST** Glulam Saddle Hangers . . . . .218  
**KHGLT** Glulam Beam Hangers . . . . .215  
**KHHB** Glulam Hangers . . . . .214  
**KHL** Heavy Angles . . . . .108  
**KHSA** Connector Straps . . . . .120-121  
**KHST** Strap Ties . . . . .115  
**KHW** Top Flange Hangers . . . . .156, 158-159  
**KLB** Beam & Purlin Hangers . . . . .155, 157  
**KLCC** Lally Column Caps . . . . .92  
**KLEG** Glulam Beam Hangers . . . . .213  
**KMEG** Glulam Beam Hangers . . . . .213  
**KNS** Protection Plate . . . . .275  
**KRPS** Strap Ties . . . . .115, 277  
**KSA** Connector Straps . . . . .120-121  
**KSCT** Corner Tie . . . . .281  
**KST** Strap Ties . . . . .112-114  
**KSTI** Strap Ties . . . . .112-114



**KTS** Twist Straps . . . . . 117-118  
**KVB** Knee Braces . . . . . 121  
**KVBI** Knee Braces . . . . . 121

**L**  
**L** Straps . . . . . 110  
**LBP** Bearing Plates . . . . . 49  
**LBPS** Bearing Plates . . . . . 49  
**LDSC** Drag Strut Connectors . . . . . 252  
**LFTA** Strap . . . . . 117-118, 234-236  
**LGU** Girder Hanger . . . . . 210  
**LGUM** Masonry Girder Hangers . . . . . 174  
**LH** Straps . . . . . 110  
**LJC** Lateral Joist Connector . . . . . 106  
**LJQ** Lateral Joist Connectors . . . . . 106  
**LL** LumberLok Screws . . . . . 39-40  
**LPTA** Embedded Truss Anchors . . . . . 219  
**LS** Light Slope Rafter Hangers . . . . . 164  
**LSSH** Slope/Skew Hangers . . . . . 165, 209  
**LSTA** Strap Ties . . . . . 112-113  
**LSTAD** Foundation Straps . . . . . 71-72  
**LSTI** Strap Ties . . . . . 112-113  
**LTS** Tension Ties . . . . . 63  
**LTTI** Tension Tie . . . . . 63  
**LTW** Twist Straps . . . . . 117-118  
**LUGT** Girder Tiedowns . . . . . 228, 232

**M**  
**MB** Bridging . . . . . 279  
**MBG** Bridging . . . . . 279  
**MGU** Girder Hanger . . . . . 210  
**ML** Angles . . . . . 100, 269  
**MP** Framing Angles . . . . . 98-99, 101-102  
**MPF** Multi-Lateral Plate Ties . . . . . 101-102  
**MPA** Framing Angles . . . . . 101-102  
**MPH** Masonry Hangers . . . . . 177-178  
**MSH** Strap Hangers . . . . . 243-245  
**MSHL/R** Skewed Truss Hanger . . . . . 246  
**MSHA** Adjustable Strap Skewed Hangers . . . . . 248-249  
**MSSHL/R** Skewed Hanger . . . . . 247  
**MSTA** Strap Ties . . . . . 112-113  
**MSTAM** Masonry Straps . . . . . 119  
**MSTC** Strap Ties . . . . . 112-114  
**MSTCB** Pre-Bent Strap . . . . . 116  
**MSTCM** Masonry Straps . . . . . 119  
**MTW** Twist Straps . . . . . 117-118  
**MUGT** Girder Tiedown . . . . . 229, 233  
**MUS** Slant Nail Joist Hangers . . . . . 124, 126-127, 138-139, 238

**N**  
**N** Bridging . . . . . 278  
**N** Nails . . . . . 22-25  
**NA** Nails . . . . . 22-25  
**NFM** Masonry Hangers . . . . . 179-180  
**NOP** Moisture Barrier Plates . . . . . 219  
**NP** Mending Plates . . . . . 282

**O**  
**O** Bridging . . . . . 278  
**Ornamental** series . . . . . 110  
**Ornamental Wood Ties** . . . . . 6

**P**  
**PA** Post Anchors . . . . . 78-79  
**PA** Purlin Anchors . . . . . 74-75

**PAE** Post Anchors . . . . . 78-79  
**PAHD** Foundation Strap . . . . . 69-70  
**PAI** Purlin Anchors . . . . . 74-75  
**PAU** Post Anchors . . . . . 78-79  
**PB** Post Caps . . . . . 90  
**PBC** Post Beam Corner . . . . . 91  
**PBES** Post Caps . . . . . 90  
**PBS** Post Caps . . . . . 90  
**PC** Plywood Clips . . . . . 273  
**PCM** Post Caps . . . . . 88  
**PCP** Plastic Post Caps . . . . . 272  
**PFM** Concrete Screw Anchors . . . . . 44  
**PHD** Preflexed Holdowns . . . . . 62  
**PHG** Panel Hangers . . . . . 168  
**PHM** Top Flange Hangers . . . . . 198-207  
**PHXU** Top Flange Hangers . . . . . 198-199, 201-203, 205-207  
**PL** Protection Plate . . . . . 275  
**Power-Stud® HD5** Anchors . . . . . 45  
**Power-Stud® SD1** Anchors . . . . . 45  
**PRT** Pipe Rail Ties . . . . . 270  
**PS** Strap Ties . . . . . 115

**R**  
**RBC** Roof Boundary Clip . . . . . 100  
**RC** Plywood Clips . . . . . 273  
**RFUS** Uplift Girder Tie . . . . . 226  
**RP** Retro Plate . . . . . 59  
**RPB** Retrofit Post Base . . . . . 77  
**RR** Ridge Rafter . . . . . 164  
**RS** Coiled Strapping . . . . . 111  
**RSPT** Stud Plate Ties . . . . . 103  
**RT** Hurricane/Seismic Anchors . . . . . 234-236  
**RTM** Hurricane Retrofit Connector . . . . . 231  
**RUSC** Strap Connector . . . . . 237  
**RW** Round Washers . . . . . 51  
**RWB** Wall Bracing . . . . . 280

**S**  
**SB** Shelf Bracket . . . . . 281  
**SBP** Bearing Plates . . . . . 260  
**SCA** Stair Angles . . . . . 107, 268  
**SDJT** Joist Tie . . . . . 109  
**SDPT** Strap Post Ties . . . . . 109  
**SFA** Foundation Anchor . . . . . 59  
**SFC** Framing Clip . . . . . 105  
**SFJA** Foundation Anchor . . . . . 59  
**SFP** Fence Post Connectors . . . . . 272  
**SHA** Masonry Uplift Connectors . . . . . 230  
**SKH** Skewed 45° Hangers . . . . . 166-167  
**SKHH** Skewed 45° Hangers . . . . . 166-167  
**SMP** Fence Post Connectors . . . . . 272  
**SNP** Skewed Nail Plate . . . . . 250  
**Specialty Options** . . . . . 283-287  
**SPT** Stud Plate Ties . . . . . 103-104  
**SPTH** Stud Plate Ties . . . . . 104  
**SPTHW** Stud Plate Ties . . . . . 104  
**SRCP** Sill Retrofit Connector Plate . . . . . 57  
**SRC** Sill Retro Connector . . . . . 58  
**ST** Foundation Anchors . . . . . 55  
**ST** Strap Ties . . . . . 112-114  
**Stabilizer** . . . . . 258  
**STAD** Foundation Straps . . . . . 71-72

**STB** Anchor Bolts . . . . . 47-48  
**STBL** Anchor Bolts . . . . . 47-48  
**STC** Scissor Truss Clips . . . . . 263  
**STS** Stud Shoes . . . . . 277  
**SUH** Joist Hangers . . . . . 123, 126-135, 137-147, 149  
**SW** Top Flange Hangers . . . . . 156-158  
**SWH** Top Flange Hangers . . . . . 156-159

**T**  
**T** Hoist Plates . . . . . 264  
**T** Straps . . . . . 110  
**TA** Foundation Straps . . . . . 73  
**TA** Truss Anchors . . . . . 225  
**TAR** Truss Anchors . . . . . 225  
**TD** Holdowns . . . . . 65-66  
**TDL** Concrete Angles . . . . . 76  
**TDX** Holdowns . . . . . 65-66  
**TFI** Top Mount Hangers . . . . . 195, 199-200, 202-203  
**TFL** Top Mount Hangers . . . . . 195, 199-200  
**TH** Straps . . . . . 110  
**THD** Face Mount Truss Hangers . . . . . 188, 193-194, 239  
**THDH** Face Mount Hangers . . . . . 188, 192-194, 240-241  
**THDQ** Girder Truss Hangers . . . . . 242  
**THF** Face Mount Hangers . . . . . 186, 191  
**THFI** Face Mount Hangers . . . . . 184, 190  
**THO** Top Mount Hangers . . . . . 195, 199-204  
**THR** Threaded Rods . . . . . 46  
**TMP** Rafter-To-Plate Connectors . . . . . 208  
**TMPH** Rafter-To-Plate Connectors . . . . . 208  
**TPP** Mending Plates . . . . . 282  
**TR** Roof Truss Ties . . . . . 263  
**TS** Truss Spacer . . . . . 259  
**TSP** Stud Plate Tie . . . . . 103, 234-236  
**TSX** Truss Spacers . . . . . 259  
**TT** D.I.Y. Products . . . . . 274  
**TUS** Undersaddle Hanger . . . . . 171

**U**  
**UGTS** Uplift Girder Ties . . . . . 227  
**UMH** Universal Masonry Hangers . . . . . 179  
**UPHD** Holdowns . . . . . 67  
**USC** Uplift Girder Ties . . . . . 227

**V**  
**VTT** Valley Truss Tie . . . . . 262

**W**  
**WAS** Wet Post Anchors . . . . . 80  
**WB** Wall Bracing . . . . . 280  
**WBC** Wall Bracing . . . . . 280  
**WBT** Wall Bracing . . . . . 280  
**WE** Wet Post Anchors . . . . . 80  
**WG** Concrete Form Wedge . . . . . 52  
**WS** Hex Head Screws . . . . . 27-29, 33  
**WSBH** Bugle Head Screws . . . . . 32  
**WSWH** Washer Head Screws . . . . . 30-31, 33-38  
**WT** Wall Ties . . . . . 172, 281

**Z**  
**Z4™** Tie-Down Systems . . . . . 290  
**ZC** Blocking Supports . . . . . 264

## About the Reference Numbers

Reference numbers shown throughout the charts in this catalog are part numbers which may be more familiar to customers in various regions of the United States. These are included for the convenience of our new customers who have recently switched from a competitor's product line to MiTek.

The reference numbers in this catalog are for general application comparison only and should not be used as a substitution tool. The user is responsible to compare specific load values, fastener schedules, material specifications, and other factors to determine suitability of use for any particular product.

<b>A</b> Angle	76, 99, 108
<b>A34/A35</b> Anchor	102
<b>ABA/ABU</b> Post Base	79
<b>ABL</b> Anchor Bolt Locator	46
<b>AC</b> Post Cap	90
<b>ATR</b> All Thread Rod	50
<b>BA</b> Hanger	158, 199-204
<b>BC</b> Base	87
<b>BC</b> Cap	89
<b>BP</b> Bearing Plate	49
<b>BPS</b> Bearing Plate	49
<b>BT</b> Brick Tie	172, 281
<b>CB</b> Column Base	84
<b>CBSQ</b> Column Base	86
<b>CC</b> Column Cap	95-96
<b>CCQ</b> Column Cap	93
<b>CHC</b> Component Hoist Clip	264
<b>CMST</b> Coiled Strap	111
<b>CMSTC</b> Coiled Strap	111
<b>CNW</b> Coupler Nut	51
<b>CPS</b> Composite Standoff	91
<b>CS</b> Coiled Strap	111
<b>DBTZ</b> Deck Tie	269
<b>DETAL</b> Truss Anchor	223
<b>DGHF</b> Drywall Hanger	161
<b>DJT</b> Deck Tie	109
<b>DPPC</b> Decorative Post Cover	272
<b>DPT</b> Deck Tie	109
<b>DS</b> Drywall Stop	273
<b>DSC</b> Drag Strut Connector	252
<b>DSP</b> Double Stud Plate	103
<b>DTC</b> Roof Truss Clip	263
<b>DTT</b> Deck Tension Tie	151-152, 266-267
<b>ECC/ECCU</b> Column Cap	96
<b>ECCQ</b> Column Cap	93
<b>EG</b> Hanger	213
<b>EGQ</b> Hanger	212
<b>EPB</b> Post Base	82
<b>EPC</b> Post Cap	88
<b>F</b> Hanger	168

<b>FB</b> Fence Bracket	153, 271
<b>FBR</b> Fence Bracket	153, 271
<b>FGTR</b> Girder Tiedown	226
<b>FJA</b> Anchor	59
<b>FPBB44</b> E-Z Base™	272
<b>FPBM44</b> E-Z Mender™	272
<b>FPBS44</b> E-Z Spike™	272
<b>FRFP</b> Foundation Plate	57
<b>FSC</b> Strap	152, 267
<b>FWANZ</b> Foundation Wall Angle	56
<b>GA</b> Angle	99
<b>GBC</b> Gable Bracing	235
<b>GH</b> Hanger	61
<b>GLB</b> Beam Seat	60
<b>GLS</b> Hanger	218
<b>H</b> Hurricane Ties	233, 235
<b>HB</b> Hanger	201-207
<b>HCA</b> Hinge Connector	216-217
<b>HCP</b> Hip Corner Plate	235
<b>HCSTR</b> Strap	217
<b>HD</b> Holdown	66
<b>HDB</b> Holdown	66
<b>HDQ</b> Holdown	67
<b>HDU</b> Holdown	62, 67
<b>HETA</b> Truss Anchor	221-222
<b>HETAL</b> Truss Anchor	224
<b>HFN</b> Hanger	168
<b>HGA</b> Gusset Angle	231
<b>HGAM</b> Gusset Angle	230
<b>HGLB</b> Beam Seat	60
<b>HGLS</b> Hanger	218
<b>HGLT</b> Hanger	202-203, 215
<b>HGLTV</b> Hanger	201-202, 205-207, 215
<b>HGT</b> Girder Tiedown	229, 233
<b>HGU</b> Girder Hanger	210
<b>HGUM</b> Girder Hanger	174
<b>HGUS</b> Hanger	193-194, 240-241
<b>HH</b> Hanger	105
<b>HHQ</b> Holdown	67
<b>HHETA</b> Truss Anchor	222
<b>HHUS</b> Hanger	193-194, 239
<b>HIT</b> Hanger	200, 202-203
<b>HL</b> Heavy Angle	108
<b>HL</b> Strap Tie	110
<b>HM</b> Hurricane Tie	231
<b>HPA</b> Purlin Anchor	75
<b>HRS</b> Strap Tie	114
<b>HS</b> Hurricane Tie	235
<b>HST</b> Strap	115
<b>HSULC/HSURC</b> Hanger	167
<b>HSUR/HSUL</b> Hanger	167
<b>HT</b> Strap Tie	110
<b>HTC</b> Heavy Truss Clip	264
<b>HTPZ</b> Strap Tie	113

<b>HTS</b> Twist Strap	118
<b>HTSM</b> Twist Strap	120
<b>HTT</b> Tension Tie	64
<b>HTU</b> Hanger	239
<b>HU</b> Hanger	126-149, 191-194
<b>HUC</b> Hanger	127-137, 139-149
<b>HUCQ</b> Hanger	128-136, 140-148, 192-194
<b>HUITF</b> Hanger	158
<b>HUS</b> Hanger	126-129, 133-134, 138-141, 145-146, 192, 238
<b>HUSC</b> Concealed Hanger	128-129, 133-134, 140-141, 145-146, 158
<b>HUSTF</b> Hanger	157-158
<b>HUTF</b> Hanger	157-159
<b>HWP</b> Hanger	201-203, 205-207
<b>HWPH</b> Hanger	202-203, 205-207
<b>IS</b> Insulation Supports	273
<b>ITS</b> Hanger	199-202
<b>IUS</b> Hanger	189-191
<b>JB</b> Hanger	157
<b>JBA</b> Hanger	157
<b>L</b> Angle	99
<b>L</b> Strap Tie	110
<b>LB</b> Hanger	157
<b>LBP</b> Bearing Plate	49
<b>LBV</b> Hanger	199-204
<b>LCC</b> Lally Column Cap	92
<b>LCE</b> Post Cap	90
<b>LEG</b> Hanger	213
<b>LGT</b> Girder Tiedown	228, 232
<b>LGU</b> Girder Hanger	210
<b>LGUM</b> Girder Hanger	174
<b>LPCZ</b> Post Cap	90
<b>LS</b> Angle	99
<b>LSC</b> Light Stair Stringer Connector	154, 267
<b>LSSJ</b> Hanger	165, 209
<b>LSSR</b> Hanger	165, 209
<b>LSTA</b> Strap Tie	113
<b>LSTI</b> Strap Tie	113
<b>LSTHD</b> Holdown	72
<b>LTA</b> Truss Anchor	219
<b>LTB</b> Bridging	278
<b>LTHJA</b> Hanger	251
<b>LTP</b> Framing Anchor	102
<b>LTS</b> Twist Strap	118
<b>LTT/LTTI</b> Tension Tie	63
<b>LU</b> Hanger	126-127, 137-139, 149
<b>LUC</b> Hanger	126-127, 138-139
<b>LUS</b> Hanger	126, 128-134, 138, 140-146
<b>MAB</b> Mudsill Anchor	55
<b>MASA</b> Mudsill Anchor	54
<b>MBHA</b> Masonry Hanger	180
<b>MBHU</b> Masonry Beam Hanger	179
<b>MEG</b> Hanger	213

<b>META</b> Truss Anchor . . . . .	222	<b>SS</b> Stud Shoe . . . . .	277
<b>MGT</b> Girder Tiedown . . . . .	229, 233	<b>SSP</b> Single Stud Plate . . . . .	103
<b>MGU</b> Girder Hanger . . . . .	210	<b>SSTB</b> Anchor Bolt . . . . .	48
<b>MIT</b> Hanger . . . . .	199-204	<b>ST</b> Strap Tie . . . . .	113
<b>MIU</b> Hanger . . . . .	189-193	<b>STC</b> Roof Truss Clip . . . . .	263
<b>ML</b> Angles . . . . .	100, 269	<b>STCT</b> Roof Truss Clip . . . . .	263
<b>MP</b> Mending Plate . . . . .	282	<b>STHD</b> Holdown . . . . .	72
<b>MST</b> Strap Tie . . . . .	114	<b>SUR/SUL</b> Hanger . . . . .	166-167
<b>MSTA</b> Strap Tie . . . . .	113	<b>T</b> Strap Tie . . . . .	110
<b>MSTAM</b> Strap Tie . . . . .	119	<b>TA</b> Staircase Angle . . . . .	107, 268
<b>MSTC</b> Strap Tie . . . . .	113-114	<b>TB</b> Tension Bridging . . . . .	278
<b>MSTCB</b> Strap Tie . . . . .	116	<b>TBE</b> Truss Enhancer . . . . .	260
<b>MSTCM</b> Strap Tie . . . . .	119	<b>TBP</b> Truss Seat . . . . .	219
<b>MSTI</b> Strap Tie . . . . .	114	<b>TC</b> Truss Connector . . . . .	263
<b>MTS</b> Twist Strap . . . . .	118	<b>THA</b> Hanger . . . . .	244-245
<b>MTSM</b> Twist Strap . . . . .	120	<b>THAC</b> Hanger . . . . .	244-245
<b>MUS</b> Hanger . . . . .	126-127, 138-139, 238	<b>THAI</b> Hanger . . . . .	244-245
<b>Nails</b> . . . . .	23, 25	<b>THAL/R</b> Hanger . . . . .	246
<b>NCA</b> Nailless Bridging . . . . .	279	<b>THASR/L</b> Truss Hanger . . . . .	249
<b>NS</b> Nail Stopper . . . . .	275	<b>THD</b> Titen HD® Anchor . . . . .	44
<b>NUT</b> . . . . .	52	<b>THGB/THGBH</b> Hanger . . . . .	255-256
<b>OHA</b> Hanger . . . . .	110	<b>THGQ/THGQH</b> Hanger . . . . .	254
<b>OL/OT/OHL/OHT</b> Hangers . . . . .	110	<b>THJA</b> Hanger . . . . .	251
<b>OS/OHS</b> Hangers . . . . .	110	<b>THJM</b> Hanger . . . . .	252
<b>PA</b> Holdown . . . . .	73	<b>THJU</b> Hanger . . . . .	251
<b>PA</b> Purlin Anchor . . . . .	75	<b>TJC</b> Truss Connector . . . . .	250
<b>PAI</b> Purlin Anchor . . . . .	75	<b>TP</b> Tie Plate . . . . .	282
<b>PB/PBS</b> Post Base . . . . .	80	<b>TS</b> Twist Strap . . . . .	118
<b>PC</b> Post Cap . . . . .	88	<b>TSBR</b> Truss Spacer . . . . .	258
<b>PF</b> Hanger . . . . .	169-170	<b>TSF</b> Truss Spacer . . . . .	259
<b>PFB/PFDB</b> Hanger . . . . .	170	<b>TSS</b> Truss Seat . . . . .	219
<b>PFDS</b> Hanger . . . . .	172	<b>TSP</b> Stud Plate Tie . . . . .	103, 235
<b>PGT</b> Pipe GripTie . . . . .	270	<b>TWB</b> Wall Bracing . . . . .	280
<b>PGTIC</b> Pipe GripTie . . . . .	270	<b>U</b> Hanger . . . . .	126-135, 137-147, 149, 190-192
<b>PS</b> Strap . . . . .	115	<b>URFP</b> Foundation Anchor . . . . .	58
<b>PSCA</b> Sheathing Clip . . . . .	273	<b>VB</b> Knee Brace . . . . .	121
<b>PSCL</b> Sheathing Clip . . . . .	273	<b>VPA</b> Connector . . . . .	208
<b>PSPNZ</b> Protective Plate . . . . .	275	<b>VTCR</b> Valley Truss Clip . . . . .	262
<b>RBC</b> Roof Boundary Clip . . . . .	100	<b>W</b> Wedge . . . . .	51
<b>RCWB</b> Wall Bracing . . . . .	280	<b>WA Wedge-All®</b> Anchor . . . . .	45
<b>RFB</b> Retrofit Bolt . . . . .	46	<b>WASHER</b> . . . . .	51
<b>RP</b> Retro Plate . . . . .	59	<b>WB/WBC</b> Wall Bracing . . . . .	280
<b>RPBZ</b> Retrofit Post Base . . . . .	77	<b>WMU</b> Hanger . . . . .	177-178
<b>RPS</b> Strap Tie . . . . .	115, 277	<b>WP</b> Hanger . . . . .	157-159, 199-204
<b>RR</b> Connector . . . . .	164	<b>WT</b> Wedge Form Tie . . . . .	52
<b>RSP</b> Stud Plate Tie . . . . .	103	<b>Z</b> Clip . . . . .	264
<b>RTA/RTB/RTC/RTF/RTR/RTU</b> Rigid Tie® . . . . .	274		
<b>SA</b> Strap Connector . . . . .	121		
<b>SBV</b> Shelf Bracket . . . . .	281		
<b>SD</b> Connector Screw . . . . .	39		
<b>SDS</b> Heavy-Duty Connector Screw . . . . .	28-29		
<b>SDW</b> Multi-Ply Wood Screw . . . . .	30-31		
<b>SP/SPH</b> Stud Plate Tie . . . . .	103-104		
<b>SPECANGLE</b> . . . . .	108		

## Code Reference Column Chart Listing

Most structural products shown in this catalog are listed in a current code evaluation report from the code evaluation agencies listed.

The load values shown in this catalog were current at the time of printing but we are continually improving our products through better engineering design and development so some of the evaluation reports may have been updated with better load values after the catalog was printed.

In a few cases, we have submitted a formal independent test report from an approved lab to the code evaluation agency and are awaiting on an evaluation report.

We recommend visiting our web site: **MiTek-US.com** or, the specified code evaluation agency's web site, shown below, to obtain the latest load values from the most current evaluation report.

- ICC-ES (ESR), [icc-es.org](http://icc-es.org)
- IAPMO Uniform-ES (ER), [iapmoes.org](http://iapmoes.org)
- City of Los Angeles (RR), [netinfo.ladbs.org](http://netinfo.ladbs.org)
- Florida (Florida Product Approval No.), [floridabuilding.org](http://floridabuilding.org)

Some code jurisdictions may require additional load reductions and/or use limitations for some products listed in this catalog. In those cases, the products may not be approved or may need further review for approval.

We recommend contacting the code jurisdiction having authority for your project to confirm they accept the evaluation reports, or contact our Engineering Department for further assistance.

## Code Reference Chart

Code Reference	Code Evaluation Agency	Building Code Coverage
IBC	ICC-ES IAPMO UES	International Building Code (IBC) International Residential Code (IRC)
FL	State of Florida Product Approvals	Florida Building Code
LA	LA City - City of Los Angeles, California	Los Angeles Building Code Los Angeles Residential Code <b>Products may have either a City of LA Research Report or a City of LA Supplement to their ICC-ES or IAPMO UES evaluation report</b>
PC	Prescriptive Code	Prescriptive construction requirements
--	None	No Code Listing

## Code Evaluation Labeling Requirements:

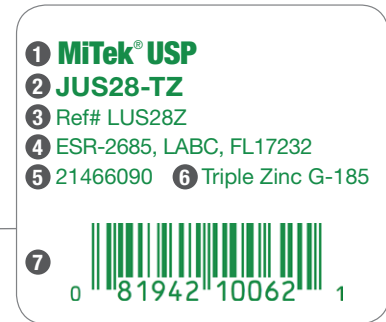
Labeling products for field identification is part of our quality assurance program. Code evaluation agencies require that the label include the manufacturer's name or trademark, the model number, and code evaluation identification number. In addition, there must also be a number to trace the product back to the steel used in manufacturing.

The primary intent of this labeling is to allow you to confirm that the connector you are looking at on the jobsite is code approved. This can be verified by checking that code evaluation identification number on the code evaluation agencies website or MiTek-US.com.

## Product Identification and Labeling



Labels are positioned on products so they can be seen after installation



Typical Product Label

Each MiTek connector is identified with the following information:

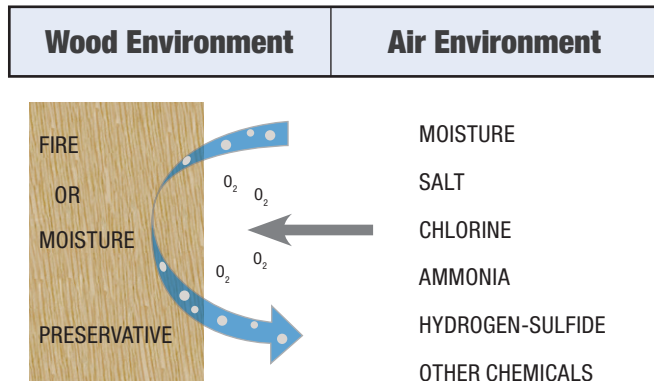
- 1 **Product Brand:** MiTek® USP
- 2 **MiTek Stock Number:** Shows stock number as it appears in MiTek's literature and code evaluation reports.
- 3 **Reference Number:** Product number of a competitor that may be specified.
- 4 **Code Evaluation Identification Number:** The code evaluation identification number(s) are listed here. ESR-2685 is a general index report from ICC Evaluation Service, Inc. (ICC-ES) and provides a convenient cross-reference to many of our ESR reports.
- 5 **Work Order Number:** For structural product traceability.
- 6 **Corrosion Information:** Shows the corrosion resistant finish of the product.
- 7 **UPC Code**

**Color Coding:** Black print indicates standard G90 finish. Green print indicates corrosion resistant finish.

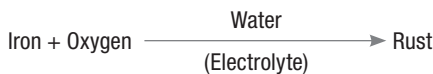
For the majority of applications, metal hangers and connectors are used in interior, above ground, dry service conditions. They are typically not being exposed to corrosive environments which can significantly reduce their strength and longevity.

### What is Corrosion?

Corrosion is the destructive degradation of steel due to its interaction with the environment. Here the steel is the connector and the environment is whatever the connector interacts with, namely wood and air. Each environment may contain one or more corrodents (substances that cause corrosion) acting independently or in combination to degrade the strength of the connectors.



Electrochemical oxidation is the most common type of corrosion affecting metal connectors. It is a process in which iron (Fe) reacts with oxygen (O<sub>2</sub>) in the presence of an electrolyte such as water (H<sub>2</sub>O) to form iron oxide (Fe<sub>2</sub>O<sub>3</sub>), a brown and flaky by-product commonly known as rust.



Steel is an iron-based metal alloy which is susceptible to this type of corrosion, even when exposed to normal atmospheric air, since air contains oxygen and water as part of its normal composition. While steel is very strong, rust is not. Over time, the continuous formation of rust eats away the base metal and reduces the strength of the connector. The rate of oxidation generally increases with increasing moisture content, the presence of salt, or when galvanic corrosion is a contributing factor.

Galvanic Series (Abbreviated)	
More Active (Anodic-)	
↑	Zinc
	Aluminum
	Steel
	Brass
	Copper Nickel
	Stainless Steel - Type 304
Stainless Steel - Type 316	
More Passive (Cathodic +)	

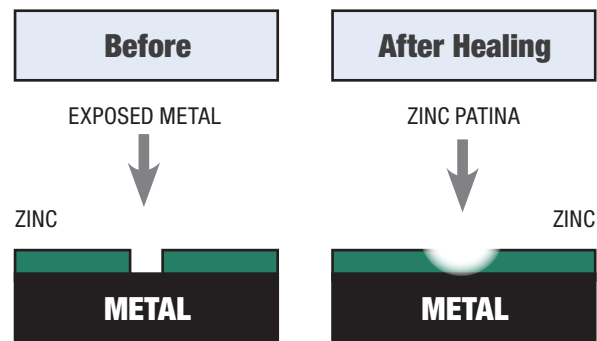
Galvanic corrosion occurs when there is an interaction between dissimilar metals that are in contact with one another. The degree of corrosion depends on where the metals reside in the galvanic series, which is a compilation of known metals and their relative reactivity. The more active metal (anode) will corrode preferentially while shielding the more

passive metal (cathode) from further degradation. For example, with galvanized steel, zinc is used as a coating on the steel because it sacrificially corrodes to protect the steel substrate underneath. The coupling between zinc and steel is said to have a lower galvanic potential than the coupling between zinc and stainless steel because zinc and steel are closer to each other in the galvanic series. In general, the coupling with a lower galvanic potential would result in a slower corrosion rate.

### Corrosion Protection Options

#### Zinc Galvanizing:

Most connectors are manufactured from pre-galvanized sheet steel or coiled steel, which is typically made by the hot-dip process in accordance with ASTM-A653 and ASTM-A924 standards. Fasteners are galvanized in accordance with ASTM-A153. In the manufacturing of the connectors, the punching and shearing processes create exposed bare metal surfaces. Thankfully, zinc has an incredible ability to 'heal' itself; the zinc around the exposed metal corrodes and deposits a layer of zinc corrosion by-product called zinc patina (white powdery appearance) over the exposed metal to further protect it.



By being more reactive than steel, zinc sacrificially corrodes at a steady rate over time to shield the steel from the effect of corrosion. The protection ability of zinc is proportional to its thickness, which is proportional to the amount of zinc applied. Zinc coating is specified as the total weight on both sides of the sheet steel, measured in ounces per square foot (oz/ft<sup>2</sup>). For example, G90 means that there are 0.90 oz/ft<sup>2</sup>; G185 has 1.85 oz/ft<sup>2</sup> and would last about two times longer than G90. G90 is the minimum protection for connectors and is standard in MiTek connectors.

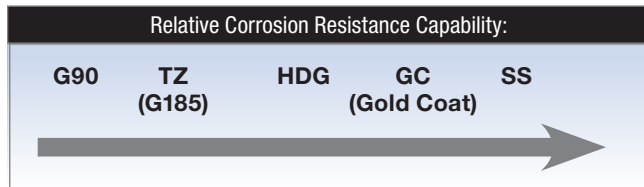
#### Design Guidelines:

Where there are governing national or local building code requirements, they should be used in the selection of the connectors and their protection against corrosion. In the absence of such requirements, the decision rests on the experience and judgment of the building designer/engineer. Design guidelines are presented in this section to aid the building designer/engineer in this selection process, but it is the responsibility of the building designer/engineer to determine the most viable solution based on an evaluation of the connectors to the specific corrosive environment(s). The guidelines consist of best practices, recommended protection levels for the connectors, and strength modification factors for the lumber/connectors.

Where there are multiple options suggested, do not automatically default to the lowest protection level. The lower protection level is intended to address less severe conditions while the higher protection level is meant to address more severe conditions. Select the option that eliminates or adequately reduces the vulnerability of the connectors to the corrodents. When in doubt, use a higher level of protection than anticipated or seek professional consultation.

## Relative Corrosion Resistance Capability:

The chart below ranks the available options in terms of their relative effectiveness against corrosion. As expected, the ability to resist corrosion increases with increasing zinc thickness, so G185 is the most durable pre-galvanized product available. Gold Coat offers enhanced protection compared to G185 while stainless steel offers the best protection for most applications.



## Galvanic Corrosion:

The simplest and most practical solution to minimize galvanic corrosion is to make sure that the components that are in direct contact with each other are made of the same material or coating. Once this is achieved, there is no net galvanic potential between the components and galvanic corrosion is eliminated or significantly reduced. For example, use galvanized nails for galvanized connectors and stainless steel nails for stainless steel connectors.

## Wet Service Condition:

For lumber, this refers to any service condition in which the average equilibrium moisture content is 15% or more over a year or may exceed 19% at any time. For lumber to get above 19% moisture, the relative humidity in the air needs to reach above 80%. Unfortunately, this is above the critical humidity level for the electrochemical oxidation of steel, which is around 70%. Beyond 70%, the rate of corrosion in the connectors increases rapidly due to the abundant availability of moisture.

G90 may not be suitable for use in wet service condition.

## Preservative (Pressure) Treated Wood:

There are many preservative wood treatment formulations available on the market today. The element that is common to most of them is the presence of copper in the formulation which can contribute to the corrosion of steel connectors and fasteners.

Of the copper based preservatives, the two types are micronized copper and soluble copper. Micronized copper formulations MCA (micronized copper azole) and MCQ (micronized copper quat) are sold under different brand names and are the most predominant formulation in today's preservative treated wood industry. Soluble copper formulations CA (copper azole) and ACQ (alkaline copper quat) have also been very popular since they replaced CCA (chromated copper arsenate) which was phased out in 2004. Other "metal free" preservatives are still used for above ground and sill plate applications, but are not as common. One of the main criterion affecting the selection of one preservative treatment over another is the type of wood being treated and how well it can be penetrated by the treatment.

While many of the advanced wood treatment formulations containing copper used today have proven to be less corrosive to steel, especially micronized copper, MiTek recommends a higher level of corrosion protection for connectors in contact with copper based wood treatments.

Connectors and fasteners in contact with metal free wood preservatives do not require additional corrosion protection due to the preservative itself, however all factors that can create the corrosive environment should be considered when selecting the appropriate finish. If unsure as to whether a particular treatment is corrosive to steel fasteners, check with the supplier of the preservative treated wood product for their recommendation.

## Fire Retardant Treated (FRT) Wood:

Although most common FRT products are not corrosive to metal connectors, not all products are non-corrosive. Additionally, they typically require proprietary strength reductions applied to the lumber in accordance with the manufacturer's specifications. Since the lumber strength is lower, the lateral and withdrawal resistance of nails must also be reduced accordingly. It is important to note that some fire retardants cause the wood to absorb more moisture from the air than untreated lumber. Consequently, the connector may be exposed to a higher level of moisture, resulting in more corrosion.

## Swimming Pools:

This is one of the most hazardous environments for steel connectors due to continuous exposure to high temperature, high moisture content, and corrosive chemicals such as chlorine, bromine, and other disinfectants. The combination of all these factors can lead to accelerated corrosion and premature structural failure. This environment is so corrosive that all possible preventive measures should be employed to prevent the hanger from being exposed to the pool water. These include the use of a vapor barrier and a ventilation system that does not take the air from the pool environment.

Additionally, it has been known that certain grades of stainless steel (316 and others) are susceptible to a mode of structural failure known as stress corrosion cracking (SCC) when exposed to a swimming pool environment. SCC is usually localized near areas of high residual stress and small cracks can rapidly propagate and cause catastrophic failures. See warning below.

### WARNING

Stainless steel connectors and fasteners shall not be used for metal hangers over swimming pools due to stress corrosion cracking. SCC has been known to occur under the following conditions:

- Use of certain grades of stainless steel (grades 316 and others).
- Structural members subjected to high tensile stress.
- Presence of certain chemicals, including chlorine and bromine.

Gold Coat may be the best choice in this environment.

The **Structural Connectors Coating Recommendations** chart below was developed by reviewing field service performance and accelerated corrosion test results. They are offered as general guidelines and are not intended to cover all possible service conditions. Additional consideration may also be needed for:

- wet service conditions
- preservative treated lumber
- fire retardant treated lumber
- strength reducing chemicals
- building near salt water coastal areas.

Additionally, the **Corrosion Protection Guidelines** to the right may also be used to assist in making the proper choice of corrosion protection.

The building designer/engineer has the ultimate responsibility of selecting the most viable protective coating based on knowledge of project specific corrosive environments and local building code requirements.

### Corrosion Protection Guidelines:

- MiTek recommends stainless steel connectors for the highest level of corrosion protection. As an economical alternative to stainless steel our new Gold Coat connectors are specifically designed for exterior application when in contact with preservative treated wood.
- For connectors in contact with preservative treated wood, the Triple Zinc option provides the minimum G-185 coating thickness required by code and is an economical alternative for exterior applications.
- The use of correct fastener with the connector is critical. Stainless steel connectors require stainless steel fasteners. For exterior applications, hot-dip galvanized fasteners (HDG) or exterior coat (EXT) must be used with both Triple Zinc and hot-dip galvanized finishes. Gold Coat connectors require gold coat or hot-dip galvanized fasteners.
- MiTek's zinc dichromate WS Wood Screws are not recommended for use with preservative or fire-retardant treated wood. Some wood screws are available in Gold Coat or exterior coat.
- MiTek clearly differentiates standard interior G90 connectors from the corrosion resistant connectors. Gold Coat connectors are distinguishable from other connectors due to their gold color.

### Structural Connectors Coating Recommendations

AWPA <sup>9</sup> Use Category	Service Conditions	Use Environment	Example Applications	Preservatives and Retentions <sup>6,7,10</sup>	Minimum Coating Requirements <sup>1,2,3,4</sup>
<b>UC1</b> Interior/Dry	Interior construction, Above ground, Dry	Continuously protected from weather or other sources of moisture	General framing, interior construction	Untreated	G90
<b>UC2</b> Interior/Damp	Interior construction, Above ground, Damp	Protected from weather, but may be subject to sources of moisture	Sill plates	SBX-DOT, Organic ACQ-D (0.15), CA-B (0.10), CA-C (0.06), MCQ (0.06), µCA-C (0.05)	G90 Triple Zinc (G-185) <sup>8,9</sup> , HDG (post hot dipped), Exterior Coat <sup>12</sup>
<b>UC3A</b> Above Ground Protected	Exterior construction, Above ground, Rapid water runoff	Exposed to all weather cycles, not exposed to prolonged wetting	Exposed exterior beams or columns in an open, covered structure	ACQ-D (0.25), MCQ (0.15), CA-B (0.10), CA-C (0.06), µCA-C (0.05), Organic	Triple Zinc (G-185), HDG (post hot dipped), Exterior Coat <sup>12</sup> or MiTek Gold Coat
<b>UC3B</b> Above Ground Exposed	Exterior construction, Above ground, Poor water runoff	Exposed to all weather cycles, including prolonged wetting	Deck beams and joists	ACQ-D (0.25), MCQ (0.15), CA-B (0.10), CA-C (0.06), µCA-C (0.05), Organic	Triple Zinc (G-185), HDG (post hot dipped), or MiTek Gold Coat
<b>UC4A</b> Ground Contact General Use	Ground contact, Fresh water; includes above ground applications	Ground contact or fresh water exposed to all weather cycles, Normal exposure	Deck posts, beams and joists. Fresh water docks <sup>11</sup>	ACQ-D (0.40), MCQ (0.23), CA-B (0.21), CA-C (0.15), µCA-C (0.14)	Triple Zinc (G-185), HDG (post hot dipped), or MiTek Gold Coat <sup>5</sup>
<b>UC4B</b> Ground Contact Heavy Duty	Exterior construction, Ground contact, Critical components	Ground contact, fresh/salt water water splash exposed to all weather cycles	Permanent wood foundations, critical structural members	ACQ-D (0.60), MCQ (0.23), CA-B (0.31), CA-C (0.25), µCA-C (0.23)	Stainless Steel

- 1) G90 and G-185 refer to galvanization requirements for ASTM A653 material.
- 2) Connectors galvanized to ASTM A123 may be used in place of either G90 or G185 coatings.
- 3) Other coating may be suitable for a given environment if the conditions are known and predictable.
- 4) For G185 connectors use fasteners galvanized per ASTM A153. For Gold Coat connectors, use Gold Coat fasteners and for stainless steel connectors, use stainless steel fasteners.
- 5) If the environment has the potential to contain elements which may make it more corrosive, the use of stainless steel is recommended.
- 6) MCQ is a micronized copper treatment such as *Micro Pro* by Koppers. µCA-C is a dispersed copper treatment manufactured by Arch Treatment Technologies. Organic preservatives include L<sup>3</sup> from Arch Treatment Technologies and EcoLife II from Viance, LLC.
- 7) For wood treatments not shown, contact MiTek or the wood preservative manufacturer for recommended coatings.
- 8) Testing by MiTek has found that in interior applications where the treated wood will remain relatively dry during its service life the use of G90 connectors with MCQ or µCA-C treated wood is appropriate.
- 9) American Wood Protection Association Standard U1-16.
- 10) SBX/DOT= Sodium Borate; ACQ-D = Alkaline Copper Quat Type D; CA-B = Copper Azole Type B; CA-C = Copper Azole Type C; MCQ = Micronized Copper Quat; µCA-C = Dispersed Copper Azole Type C. The number listed in the parenthesis is the required retention level in pounds per cubic foot, or PCF.
- 11) Deck joists and beams must be treated to Use Category UCA4 when they are difficult to maintain, repair or replace and are critical to the performance and safety of the deck.
- 12) Users must perform periodic inspection and provide regular maintenance to ensure the satisfactory performance of the structure.

## Corrosion Resistant Finishes

MiTek offers several corrosion resistant finishes to cover a range of corrosion performance. For products available in corrosion resistant finishes, reference the “Corrosion Finish” column in the charts and Corrosion Key located by the chart footnotes or pages 17-18 for a complete listing of corrosion resistant products.

Corrosion Protection Level	Finish / Material	Description	Required Fastener	Ordering
<b>CONNECTORS</b>				
	Primer	Primer paint is used to protect steel during shipping and installation but is not considered a corrosion protection method when installed in corrosive environments.	Bright fasteners	Stock number as listed in the chart
	G90 Galvanizing	Galvanizing provides a prefabrication coating of 0.90 ounces of zinc per square foot of surface area (both sides) measured in accordance with ASTM A 653.	Bright fasteners	Stock number as listed in the chart
	Triple Zinc (TZ) (G-185 Galvanizing)	TZ galvanizing provides a prefabrication coating of 1.85 (G-185) ounces of zinc per square foot of surface area (both sides) measured in accordance with ASTM A 653.	Hot-dip galvanized or Exterior Coat fasteners	To order, add TZ to stock number, as in C44-TZ
	Hot-Dip Galvanized (HDG)	HDG coating provides an after-fabrication hot-dipped zinc coating. The coating thickness is dependent on the connector material, but generally ranges from 1.2 to 2.3 ounces of zinc per square foot of surface area (both sides). Hot-dip products meet requirements set forth in ASTM A 123.	Hot-dip galvanized or Exterior Coat fasteners	To order, add HDG to stock number, as in KCC44-HDG
	Gold Coat (GC)	Gold Coat is a proprietary multi-layer protection system. It is comprised of an organic top coat barrier layer and a zinc layer placed over a steel substrate.	Gold Coat or Hot-dip galvanized fasteners	To order, add GC to stock number, as in AC7-GC
	Stainless Steel (SS)	Best option for corrosion protection. Quality stainless steel (316SS grade steel) is used to fabricate connectors. Although costs are higher, some applications may need the virtual corrosion proof quality of stainless steel.	Stainless Steel fasteners	To order, add SS to stock number, as in PBES44-SS
<b>FASTENERS</b>				
	Yellow Zinc	Zinc yellow chromate finish		Stock number as listed in the chart
	Hot-Dip Galvanized (HDG)	HDG coating provides an after-fabrication hot-dipped zinc coating. The coating thickness is dependent on the connector material, but generally ranges from 1.2 to 2.3 ounces of zinc per square foot of surface area (both sides). Hot-dip products meet requirements set forth in ASTM A 123.		Stock number as listed in the chart
	Exterior Coat (EXT)	EXT finish is a double barrier coating over zinc.		Stock number as listed in the chart
	Gold Coat (GC)	Gold Coat is a proprietary multi-layer protection system. It is comprised of an organic top coat barrier layer and a zinc layer placed over a steel substrate.		Stock number as listed in the chart
	Stainless Steel (SS)	Best option for corrosion protection.		Stock number as listed in the chart

**DISCLAIMER** – The general information and guidelines provided in this MiTek Product Catalog shall not be used as a substitute for competent professional examination and verification. It is the responsibility of the building designer/engineer to determine the applicability and suitability of the information provided. Anyone making use of this information assumes all responsibility and liability arising from such use.



## Corrosion Resistant Product Offering

MiTek USP Stock No.	Triple Zinc G-185 (TZ)	Hot-Dip Galv. (HDG)	Exterior Coat (EXT)	Gold Coat (GC)	Stain-less Steel (SS)	MiTek USP Stock No.	Triple Zinc G-185 (TZ)	Hot-Dip Galv. (HDG)	Gold Coat (GC)	Stain-less Steel (SS)	MiTek USP Stock No.	Triple Zinc G-185 (TZ)	Hot-Dip Galv. (HDG)	Gold Coat (GC)	Stain-less Steel (SS)
<b>Fasteners / Anchors</b>						<b>Holdowns / Foundation Anchors</b>					<b>Column / Post Caps</b>				
AB1212-HDG						STB24					PB66-6TZ				
AB126-HDG						STB28					PBC44-TZ				
AB128-HDG						STB34					PBC66-TZ				
AB5812-HDG						STB36					PBES44				
BP12						STBL24					PBES66				
BP583						STBL28					PBS44				
HBPS12						TA51					PBS66				
HBPS58						TA71					PBS66R				
LBP12-TZ						TDL5					PCM44				
LBP58-TZ						TDX2-TZ					PCM4416				
LBPS12-TZ						<b>Column / Post Caps</b>					PCM46				
LBPS58-TZ						BC400-TZ					PCM4616				
LL915						BCS22-4					PCM4816				
LL930						BCS23-6					PCM66				
N10C						C44					PCM6616				
N10-GC						C46					<b>Column / Post Bases</b>				
N16C						C46R					CBSQ44-TZ				
N8-GC						C66					CBSQ46-TZ				
NA11						C66R					CBSQ66-TZ				
NA16D						EPCM4416					D44-TZ				
NA20D						EPCM4616					D46				
NA9D						EPCM6616					D46R-TZ				
NA8DHDGPT						EPCM66					D66				
N8CHDGPT						KCC325-4					D66R				
NA10DHDGPT						KCC325-6					EBG44-TZ				
N10CHDGPT						KCC44					EBP44T-TZ				
NA16DHDGPT						KCC46					EPB4408				
SSN10C						KCC48					EPB4608				
SSN16C						KCC525-4					EPB6608				
SSN8C						KCC525-6					EPBH44				
SSNA10D						KCC64					EPBH46R				
SSNA8D						KCC66					EPBH66				
THR1218-HDG						KCC68					EPBH66R				
THR1224-HDG						KCC88					KCB44				
THR1236-HDG						KCCQ325-4					KCB46				
THR125-HDG						KCCQ325-6					KCB48				
THR126-HDG						KCCQ44					KCB66				
THR128-HDG						KCCQ46					KCB68				
THR5812-HDG						KCCQ48					KCB88				
THR5816-HDG						KCCQ525-4					KCB1010				
THR588-HDG						KCCQ525-6					KCB1212				
WS15						KCCQ525-8					KCBQ44				
WS2						KCCQ64					KCBQ46				
WS25						KCCQ66					KCBQ66				
WS3						KCCQ71-4					KCBQ88				
WS35						KCCQ71-6					PA44E				
WS45						KCCQ74					PA44				
WS6						KCCQ76					PA46E				
WS8						KECC325-4					PA46				
WSBH25-EXT						KECC325-6					PA55R-TZ				
WSBH4-EXT						KECC44					PA66E				
WSBH6-EXT						KECC46					PA66ER-TZ				
WSBH8-EXT						KECC525-4					PA66R				
WSBH10-EXT						KECC525-6					PA66				
WSWH278						KECC64					PAU44				
WSWH358-EXT						KECC66					PAU46				
WSWH45						KECC68					PAU66				
WSWH5						KECC88					PAU66R-TZ				
WSWH6						KECCQ325-4					PAU88				
WSWH8-EXT						KECCQ325-6					PAU1010				
<b>Holdowns / Foundation Anchors</b>						<b>Holdowns / Foundation Anchors</b>					<b>Framing Plates &amp; Angles</b>				
FA3						KECCQ44					A3				
FA4						KECCQ46					AC5				
FWAN-TZ						KECCQ48									
LTS19-TZ						KECCQ525-4									
PA18						KECCQ525-6									
PA23						KECCQ525-8									
PA28						KECCQ64									
RP6						KECCQ66									
ST1-TZ						KECCQ71-4									
ST2-TZ						KECCQ71-6									
STB16						KECCQ74									
STB20						KECCQ76									
						PB44-6TZ									

**Corrosion Finish**  
■ Stainless Steel  
■ Gold Coat  
■ Exterior Coat  
■ HDG  
■ Triple Zinc

Copyright © 2019 MiTek Industries, Inc. All Rights Reserved

## Corrosion Resistant Product Offering

MiTek USP Stock No.	Triple Zinc G-185 (TZ)	Hot-Dip Galv. (HDG)	Gold Coat (GC)	Stainless Steel (SS)	MiTek USP Stock No.	Triple Zinc G-185 (TZ)	Hot-Dip Galv. (HDG)	Gold Coat (GC)	Stainless Steel (SS)	MiTek USP Stock No.	Triple Zinc G-185 (TZ)	Hot-Dip Galv. (HDG)	Gold Coat (GC)	Stainless Steel (SS)
<b>Framing Plates &amp; Angles</b>					<b>Straps</b>					<b>Hangers</b>				
AC7					MSTAM36					SKH28R				
AC9					PS218-HDG					SKHH210L-2				
ANJ44S-HDG					PS418-HDG					SKHH210L-2IF				
JA1					PS720-HDG					SKHH210R-2				
KHL33					RS150					SKHH210R-2IF				
KHL35					RS16-R					SKHH410L				
KHL37					T6					SKHH410LIF				
KHL43					TH12-HDG					SKHH410R				
KHL46					<b>Hangers</b>					SKHH410RIF				
KHL55					HD210-2IF					SKHH414LIF				
KHL57					HD210-3IF					SKHH414RIF				
KHL76					HD28-2IF					SKHH46L				
ML24-TZ					HD410					SKHH46LIF				
ML26-TZ					HD410IF					SKHH46R				
MP3					HD412					SKHH46RIF				
MP34					HD412IF					SUH210				
MP4F					HD44IF					SUH210-2				
MP5					HD46					SUH210-3				
MP6F					HD46IF					THD28-2				
MP7					HD48					THD410				
MP9					HD48IF					THD46				
MPA1					HD610					THD48				
<b>Stud Plate Ties</b>					HD610IF					THDH412				
RSPT6					HD612					THDH610				
RSPT6-2					HD612IF					<b>Hurricane Ties</b>				
SPT22					HD68					HHCP2				
SPT24					HD68IF					HHCP4-TZ				
SPT4					HDQ210-2IF					LFTA6				
SPT6					HDQ210-3IF					RT10				
SPT8					HDQ310IF					RT15				
SPTH4					HDQ410IF					RT16-2				
SPTH6					HDQ412IF					RT16A				
SPTH8					HDQ610IF					RT20				
TSP					HDQ612IF					RT3A				
<b>Lateral Joist Connectors</b>					HUS210					RT4				
LJC-TZ					HUS210-2IF					RT5				
LJQ15-TZ					HUS212-2					RT7				
LJQ17-TZ					HUS26					RT7A				
LJQ20-TZ					HUS28					RT8A				
LJQ23-TZ					HUS28-2IF					<b>Embedded Truss Anchors</b>				
LJQ25-TZ					JL210IF-TZ					HTA20				
LJQ35-TZ					JL24IF-TZ					<b>Deck &amp; Fences</b>				
<b>Twist Straps</b>					JL26IF-TZ					ADTT-TZ				
HTW20					JL28IF-TZ					CSH-TZ				
LTW12					JPF24					DC50-TZ				
LTW18					JPF26					DTB-TZ				
MTW12					JUS210					ERB24-TZ				
MTW16					JUS210-2					FB14-TZ				
MTW20					JUS210-3					FB23-TZ				
MTW30					JUS24					FB24-TZ				
<b>Straps</b>					JUS24-2					FB26-TZ				
HRS416-TZ					JUS26					FRB24-TZ				
HTP37-TZ					JUS26-2					PRT15-TZ				
KHST2					JUS28					PRT2H-TZ				
KHST3					JUS28-2					PRT2-TZ				
KRPS22					JUS28-3					PRTIC2-TZ				
KRPS28					JUS36					SCA10-TZ				
KST227					JUS410					SCA9-TZ				
KST237					JUS44					SDJT14-TZ				
KST248					JUS46					SDPT5-TZ				
KST260					JUS48					SDPT7-TZ				
L6					KLB210					<b>General Hardware</b>				
LH12					LSSH15-TZ					ICPL516-TZ				
LSTA36					LSSH210					ICPL58				
MSTA12					LSSH31					TTA12-TZ				
MSTA15					MSH422					TTA2-TZ				
MSTA18					SKH210L					TTB22-TZ				
MSTA21					SKH210L-2					TTC24-TZ				
MSTA24					SKH210R					TTC42-TZ				
MSTA30					SKH210R-2					TTF22-TZ				
MSTA36					SKH26L					TTR-TZ				
MSTA9					SKH26R					TTU2-TZ				
MSTAM24					SKH28L					WT22				

**Corrosion Finish**  
■ Stainless Steel  
■ Gold Coat  
■ Exterior Coat  
■ HDG  
■ Triple Zinc

## U.S. Standard Steel Gauge Equivalents in Nominal Dimensions

Gauge	Approximate Dimensions		Decimals (inches)		
	Inches	Millimeters	Uncoated Steel	Galvanized Steel (G90)	Triple Zinc (G-185)
3	1/4	6.0	0.238	--	--
7	3/16	4.5	0.171	0.186	--
10	9/64	3.4	0.129	0.138	0.140
11	1/8	3.0	0.114	0.123	0.125
12	7/64	2.7	0.099	0.108	0.110
14	5/64	2.0	0.070	0.078	0.080
16	1/16	1.5	0.055	0.063	0.065
18	3/64	1.2	0.044	0.052	0.054
20	1/32	1.0	0.033	0.040	0.042
22	1/32	0.8	0.029	0.033	0.036

\*Actual steel dimensions will vary from nominal dimensions according to industry tolerances.

## Maximum Shear Capacity of Joist or Rafter

The table below indicates the calculated shear capacity of different dimensional lumber sizes for various wood species.

Wood Species	Allowable Shear on Bending Member <sup>1,2,3</sup>											
	Joist or Rafter											
	2 x 4			2 x 6			2 x 8			2 x 10		
	100%	115%	125%	100%	115%	125%	100%	115%	125%	100%	115%	125%
DF	630	725	788	990	1139	1238	1305	1501	1631	1665	1915	2081
SP	613	704	766	963	1107	1203	1269	1459	1586	1619	1862	2023
S-P-F	473	544	590	743	854	928	979	1126	1223	1249	1436	1561
Hem Fir	525	604	656	825	949	1031	1088	1251	1359	1388	1596	1734

- 1) Applies to nominally dimensioned joists as listed, where moisture content < 19% and temperature < 100° F.
- 2) Loads apply to: DF: Douglas Fir-Larch (G=0.50), Fv=180 psi; SP: Southern Pine (G=0.55), Fv=175psi; S-P-F: Spruce-Pine-Fir (G=0.42), Fv=135psi; Hem Fir (G=0.43), Fv=150psi.
- 3) 115% and 125% loads are increased for short-term loading in accordance to the code.

## Roof Pitch

If common Rafter Roof Pitch is . . .		Then Hip/Valley Rafter Roof Pitch becomes . . .		Slope Conversion Table	
Rise / Run (inches)	Slope (degrees)	Rise / Run (inches)	Slope (degrees)	Rise / Run (inches)	Slope (degrees)
1/12	5	1/17	3	0/12	Flat
2/12	10	2/17	7	1/12	5
3/12	14	3/17	10	2/12	10
4/12	18	4/17	13	3/12	14
5/12	23	5/17	16	4/12	18
6/12	27	6/17	19	5/12	23
7/12	30	7/17	22	6/12	27
8/12	34	8/17	25	7/12	30
9/12	37	9/17	28	8/12	34
10/12	40	10/17	30	9/12	37
11/12	42	11/17	33	10/12	40
12/12	45	12/17	35	11/12	42
				12/12	45

- 1) Use this conversion table only for hip/valley rafters that are skewed 45° right or left. All other skews or dual pitch roofs will cause the slope to change from that listed above.

## Special & Custom Connectors

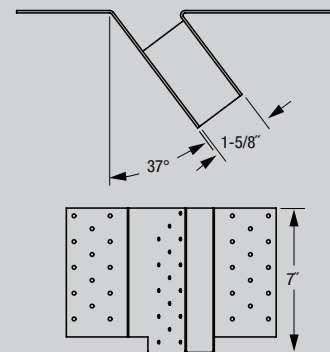
MiTek is committed to meeting every need you have and we understand that stock connectors will not meet all application or design requirements. Our Technical Assistance Representatives will work with you to develop and fabricate the Special or Custom connector you need.

### What is the difference between a “Special” and a “Custom” connector?

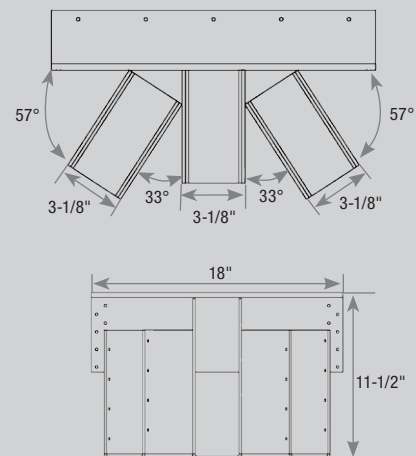
A “Special” is a stock MiTek connector that is modified within the limits listed in the Specialty Options chart for that connector. A summary of Specialty Options can be found on page 283 of this catalog.

A “Custom” is a connector that does not closely resemble a stock or special part offered in our catalog. Also, a “Custom” connector may be a stock connector that is modified outside of the limits listed in the Specialty Options charts or is not listed in the catalog as having a specialty option available. Product drawings must be provided by the customer and will be manufactured by MiTek in accordance to customer specifications. Customs should be verified prior to ordering and are not refundable.

See page 283-286 for additional information.



Special Order EXAMPLE: Skewed HD < 45°



Custom Order EXAMPLE: HLBH 3 pocket Girder Truss Hanger

## Product Notes

- 1) This catalog reflects the most current information available at the time of printing. However, we are continually improving our products through better engineering design and development and recommend visiting our website for the latest on-line version of the catalog at MiTek-US.com. MiTek reserves the right to change specifications, designs, and models at any time without notice and liability for such changes. This catalog may not be reproduced in whole or in part without the prior written approval of MiTek.
- 2) This catalog reflects changes to product design and allowable loads to some MiTek USP products. The information presented in this publication supersedes all previously published Product Catalogs.
- 3) This Product Catalog was designed as a general reference for the MiTek Product Line. Various specialized publications have also been developed for design professionals, truss manufacturers, contractors, and building material distributors. Consequently, product information may vary from one publication to another due to product development testing and revisions to code evaluation report upgrades. We recommend visiting our website for the latest on-line version of these specialized publications.
- 4) The type and quantity of fasteners used to install MiTek USP products is critical to connector performance. To achieve the allowable loads presented in this catalog, all specified fasteners must be used and proper installation procedures observed (refer to footnotes under Allowable Loads tables in the product's ICC-ES ESR code evaluation report for possible substitution of TECO brand pneumatic nails). Verify that the dimensions of the supporting members are sufficient to receive the specified fasteners. All product modifications will void the warranty unless prior written consent from MiTek has been obtained.
- 5) Some connector models are listed more than once to indicate installation and/or fastener options.
- 6) New products or updated product information are designated in **blue**.
- 7) Throughout this catalog, dimensions are expressed in inches and loads in pounds unless specifically noted otherwise.
- 8) Some MiTek USP products show both nail fastening and bolt schedules. In those cases, specific loads for each has been identified. Nail and bolt values cannot be combined unless noted otherwise.
- 9) Load values for 8d, 10d, 16d, and 20d designations in the fastener schedules throughout this catalog refer to common wire nails unless noted otherwise. Nails shall conform to a recognized national standard, such as ASTM F1667, as prescribed by the model building codes.
- 10) Diamond holes are for optional nailing for maximum listed capacity or for temporary hanger fastening during installation.
- 11) Fastener installation may cause wood to split and reduce a fastener's ability to transfer loads into the supporting member. **If wood splitting occurs, consider pre-drilling holes not exceeding 75% of the nail diameter (per the National Design Specification for Wood Construction (NDS) Section 12.1.5.3).**
- 12) Bolts specified in this catalog are through-bolts and must conform to requirements for ASTM A 307 Grade A, or ASME SAE Grade 2, or better unless noted otherwise.
- 13) Anchor Bolts must conform to ASTM F 1554.

- 14) MiTek USP connectors listed in this catalog are manufactured for specific sizes of standard dimensional lumber, plated trusses, or structural composite lumber. **For applications involving unusual supporting conditions environments, contact MiTek. Wood shrinkage or expansion, caused by lack of moisture or excessive moisture, may adversely affect connector installation. Evaluate potential shrinkage or expansion to ensure proper connector installation and performance.**
- 15) The load values listed in this catalog are based on installation to wood with a moisture content of less than 19%, and used in dry service conditions. Load reductions, in accordance with the applicable local Building Code, shall be taken where wood moisture content is greater than 19% at the time of installation or where used in wet service conditions.
- 16) Unless otherwise noted, MiTek USP products may not be bent or cut for any reason unless prior written consent from MiTek has been obtained. **Field alterations may significantly reduce the published allowable load values in this catalog.**

## Design Notes

- 1) Some products have allowable loads that can be applied in several directions (F1, F2, and uplift is a common example). When these products have F1, F2 and/or uplift loads applied simultaneously, it is necessary to make the following check:
 
$$\frac{F_1 \text{ applied}}{F_1 \text{ allowable}} + \frac{F_2 \text{ applied}}{F_2 \text{ allowable}} + \frac{\text{Uplift applied}}{\text{Uplift allowable}} \leq 1.0$$

As an alternative check for simultaneous loads in more than one direction for embedded truss anchors (pages 219-225), LUGT girder tiedowns (pages 228 and 232), hurricane angles and connectors (pages 230-231), and hurricane ties (pages 234-236); the applied load in each direction shall not exceed 75% of the listed allowable load in the corresponding direction.
- 2) Unless otherwise noted, the allowable loads shown in this catalog are based on Allowable Stress Design methodology. **Multiply seismic and wind ASD load values by 1.4 or 1.6 respectively to obtain LRFD values.**
- 3) Connector capacities may exceed the allowable capacity of the wood members involved in the connection. A qualified designer should verify that all wood members (supporting and supported) have been properly designed for the connector.
- 4) Verify that the size of the supporting member can accommodate the connector's specified fasteners.
- 5) Some illustrations in this catalog may not reflect additional mechanical reinforcements which may be required to reduce cross grain tension or wood member bending under loading. The design professional is responsible for determining if additional mechanical reinforcement is required during construction.
- 6) MiTek recommends the hanger height be 60% of the joist height for stability during construction.

### 2015 NDS® Standards

Unless otherwise noted, the allowable load values presented in this catalog reflect the calculation criteria set forth in the 2015 National Design Specification for Wood Construction (NDS®) published by the American Forest and Paper Association; with the methodology prescribed in ICC-ES AC13 or other relevant acceptance criteria applied.

## Material

MiTek selects steel for its various products in accordance with application needs and steel properties, including tensile strength, ductility, corrosion resistance, gauge, and weldability. See specific code evaluation reports or consult MiTek for additional steel information on specific products. USP products are manufactured from steel which meets ASTM A 653, ASTM A 1011, or ASTM A 36, ASTM A1018 or ASTM A666 standards.

## Testing and Product Design Loads

On all structurally-rated products, MiTek performs calculations and full-scale testing in accordance with ICC-ES AC13, ASTM D 1761, and other applicable ICC-ES acceptance criteria and standards recognized by model code agencies. All testing is conducted or verified by an approved LAS accredited third-party testing laboratory which generates an independent test report. In accordance to these standards the design loads for joist hangers and similar devices listed are the lowest results obtained from one of the following methods:

- 1) The lowest ultimate tested load divided by three.
- 2) Average load producing 1/8" deflection.
- 3) Calculations based 2015 NDS® and applicable Standards.

The allowable loads for some products have been increased in accordance with the NDS® by applying a Load Duration Factor,  $C_D$ , for fasteners in wood. Stress increases have not been applied to steel components of the products.

Floor / Design Load ..... 100% (no increase).

Roof Snow ..... 115% of design load for 2-month duration of load

Roof Non-Snow ..... 125% of design load for 7-day duration of load.

Uplift ..... 160% of design load for wind/seismic loading

## Spruce-Pine-Fir or Hem Fir Equivalent Capacity

Unless otherwise noted, the published design loads in this catalog apply to Douglas Fir-Larch or Southern Pine lumber. When Spruce-Pine-Fir or Hem Fir lumber is used with face mount hangers or straps, the allowable load capacity may be adjusted according to the chart below.

Allowable Load Adjustment Factor		
Wood Species	Specific Gravity	Adjustment Factor
Douglas Fir-Larch (DF)	0.50	1.00
Southern Pine (SP)	0.55	1.00
Douglas Fir (S) Hem Fir (N)	0.46	0.88
Spruce-Pine-Fir (S-P-F)	0.42	0.86

- 1) Allowable loads must be adjusted according to the applicable wood species.
- 2) When using structural composite lumber, verify wood species and use above listed adjustment factors.

## Installation Notes

- 1) Use proper safety equipment during connector installations. Always wear gloves when handling connectors.
- 2) All welding should be done in accordance with the American Welding Society (AWS) Standard by a certified welder. **Caution: Welding galvanized steel may produce harmful fumes and should only be performed in well-ventilated environments.**
- 3) The proper type and quantity of fasteners must be used to install MiTek products. To achieve the published allowable loads, install with the fasteners specified for that particular product. Some products allow for alternate nail installations. Refer to the "Optional Nails for Face Mount Hangers" chart on page 22 of this catalog for load adjustments when using alternate nailing. All specified fasteners must be properly installed prior to applying load to the connection.
- 4) Drill bolt holes a minimum of 1/32" and a maximum of 1/16" larger than the diameter of the bolt to be installed (per the 2015 NDS®, Section 11.1.3).
- 5) Washers should always be used under the head or nut of a bolt when not in contact with the connector unless noted otherwise.
- 6) It may be permissible to install some connectors with TECO pneumatic nails provided the nail length and diameter are the same and are installed through all pre-punched nail holes. MiTek recommends the use of nail guns featuring hole-locating mechanisms. Please note that many nail guns use fasteners that are shorter than the common nail size and load reductions will result. Contact MiTek Engineering. **Caution: Always follow nail gun manufacturer's safety guidelines.**
- 7) Joists installed in hangers should bear fully on the connector seat and shall be cut to fit against the header with a gap no greater than 1/8" between the joist end and header face.
- 8) Multiple-ply members must be properly fastened together to distribute loads as a single member.
- 9) Top mount hangers shall be installed with the back of the hanger tight to the face of the header.
- 10) Top mount hangers installed in floor systems may produce unevenness. This will vary based on thickness of the top flange and nail heads. **If a problem is anticipated, the effects can be mitigated by dapping or notching the beam or cutting the subfloor at hanger locations. Face mount hangers will eliminate this problem.**

### THIS IS A REQUIREMENT ONLY FOR THE STATE OF CALIFORNIA.

Based on our experience, we do not believe that our products when used as intended present an exposure risk of ingestion, inhalation or by absorption through the skin to any of Prop 65's current list of chemicals. Nonetheless, out of an abundance of caution, and in the event our MiTek products are misused or used in ways we do not foresee, we are taking the precaution of placing a short-form Prop 65 warning on the labels of our retail packaged products, and in some instances, on signs posted in the California retail locations where our products are sold to consumers without labels.

MiTek manufactures and supplies some products that are not intended as consumer products, and are sold through professional construction supply channels and/or delivered directly to job sites. These products will not carry the Prop 65 warning. To learn more about the California Proposition 65, visit [www.P65Warning.ca.gov](http://www.P65Warning.ca.gov). For MiTek specific questions please contact MiTek Customer Service at 800-328-5934 with any questions or visit our website, [MiTek-US.com](http://MiTek-US.com).

Proper fasteners are a critical component in a sound wood frame structure. To ensure successful installations of its connectors, MiTek offers a full range of structurally-rated nails. All galvanized nails supplied by MiTek are Hot-dipped for greater corrosion resistance. Any MiTek connector requiring a NA16D-RS or NA20D nail is shipped with the nails attached to the connector in convenient poly bags.

**Finish:** See Nail Specification Table on page 23.

**Materials:** ASTM A 123; ASTM A 153 (HDG)

**Installation:**

- Allowable shear values assume nail embedment into the wood of the entire nail or 10 nail diameters (whichever is less). Otherwise, the nail must be embedded at least 6 nail diameters, with the load reduced using the equation below:

$$\text{Reduced Load} = \frac{\text{Published Load} \times \text{Actual Penetration}}{\text{Nail Diameter} \times 10}$$

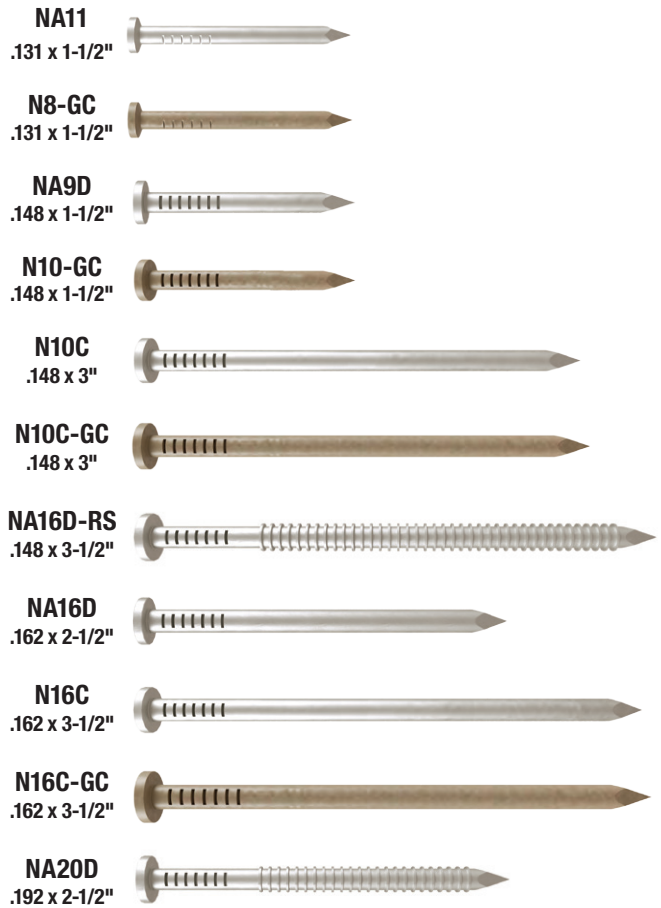
- Load reductions may occur if nails are used other than those specified. See the chart [Optional Nails for Face Mount Hangers](#) below for load reduction factors regarding nail substitutions.
- For pneumatic nail use, see Installation Notes on page 21 and reference MiTek's technical bulletins.

**Optional Nails for Face Mount Hangers and Straight Straps**

(excludes slant nail hangers)

Catalog Nail	Replacement Fastener <sup>1</sup>	Allowable Load Adjustment Factor		
		DF	SP	S-P-F
8d x 1-1/2 (0.131" x 1-1/2")	8d x 1-1/2 (0.131" x 1-1/2")	1.00	1.00	0.87
	No. 8 (0.164") x 1-1/2 Wood Screw	0.96	1.00	0.83
8d common (0.131" x 2-1/2")	8d Box (0.113" x 2-1/2")	0.77	0.83	0.67
	8d x 1-1/2 (0.131" x 1-1/2")	1.00	1.00	0.87
	No. 8 (0.164") x 1-1/2 Wood Screw	0.96	1.00	0.83
10d x 1-1/2 (0.148" x 1-1/2")	8d x 1-1/2 (0.131" x 1-1/2")	0.83	0.90	0.72
	No. 8 (0.164") x 1-1/2 Wood Screw	0.80	0.87	0.69
10d common (0.148" x 3")	8d Box (0.113" x 2-1/2")	0.64	0.69	0.55
	10d Sinker (0.120" x 2-7/8")	0.71	0.76	0.61
	8d common (0.131" x 2-1/2")	0.83	0.90	0.72
	10d Box (0.128" x 3")	0.80	0.87	0.69
	8d x 1-1/2 (0.131" x 1-1/2")	0.83	0.90	0.72
	10d x 1-1/2 (0.148" x 1-1/2")	1.00	1.00	0.87
	16d Sinker (0.148" x 3-1/4")	1.00	1.00	0.87
12d common (0.148" x 3-1/4")	No. 8 (0.164") x 1-1/2 Wood Screw	0.80	0.87	0.69
	10d x 1-1/2 (0.148" x 1-1/2")	1.00	1.00	0.87
	16d Sinker (0.148" x 3-1/4")	1.00	1.00	0.87
16d common (0.162" x 3-1/2")	No. 8 (0.164") x 1-1/2 Wood Screw	0.80	0.87	0.69
	8d common (0.131" x 2-1/2")	0.70	0.76	0.61
	10d Box (0.128" x 3")	0.67	0.73	0.58
	10d common (0.148" x 3")	0.84	0.91	0.73
	12d common (0.148" x 3-1/4")	0.84	0.91	0.73
	10d x 1-1/2 (0.148" x 1-1/2")	0.84	0.91	0.73
	10d Sinker (0.148" x 2-7/8")	0.60	0.65	0.52
	16d Box (0.135" x 3-1/2")	0.74	0.80	0.65
	16d Sinker (0.148" x 3-1/4")	0.84	0.91	0.73
	16d x 2-1/2 (0.162" x 2-1/2")	1.00	1.00	0.86
No. 8 (0.164") x 1-1/2 Wood Screw	0.67	0.73	0.58	

1) No. 8 x 1-1/2 Wood Screw shall conform to ANSI/ASME Standard B18.6.1-1981.  
 2) This chart does not apply to HUS, JDS, JH, JPF, JUS, MSH, MUS or THDH slant nail hangers.



**How to Use:**

The base value is the catalog listed nail in Douglas Fir-Larch and the adjustment factor is the multiplier for the applicable replacement nail and wood combination.

- Adjustment factors may vary with some custom hangers or steel thicker than 10 gauge. Contact MiTek for exceptions.
- Roofing nails shall not be substituted for any nail size or type.



**Optional Nails Example:**

**JL210** – listed load is 1650 lbs. @ 100% for 10d common nails.

If substituting:

8d common nails with DF-L or LVL:  
 1650 lbs. x .83 = 1369 lbs.

8d common nails with SP:  
 1650 lbs. x .90 = 1485 lbs.

8d common nails with S-P-F:  
 1650 lbs. x .72 = 1188 lbs.

**No further reductions are required.**

**Nail Specification Table**

Finish <sup>3,7</sup>	Size	MiTek USP Stock No. <sup>7</sup>	Ref. No.	Dimensions (in)			DF/SP Allowable Shear per Nail (Lbs.) <sup>1,2,4,5</sup>								Withdrawal Load <sup>6</sup>	Corrosion Finish	
				Nail Diameter	Length	Nails Per Lb.	Steel Gauge										
							3	7	10	12	14	16	18	20			22
HDG	8d x 1-1/2	NA11	N8	0.131	1-1/2	152	--	--	--	--	--	96	95	94	94	32	
	10d x 1-1/2	NA9D	N10	0.148	1-1/2	100	--	--	139	127	119	116	114	114	113	36	
	10d Common	N10C	10DHDG	0.148	3	70	--	158	139	127	119	116	114	114	113	36	
	16d x 2-1/2	NA16D	N16, N16EG	0.162	2-1/2	66	194	181	161	149	141	138	137	136	--	40	
	16d Common	N16C	16DHDG	0.162	3-1/2	48	194	181	161	149	141	138	137	136	--	40	
	20d x 2-1/2	NA20D	--	--	0.192	2-1/2	41	234	207	187	175	168	--	--	--	47	
GC	8d x 1-1/2	N8-GC	--	0.131	1-1/2	152	--	--	--	--	--	96	95	94	94	32	
	10d x 1-1/2	N10-GC	--	0.148	1-1/2	100	--	--	139	127	119	116	114	114	113	36	
	10d Common	N10C-GC	--	0.148	3	70	--	158	139	127	119	116	114	114	113	36	
	16d Common	N16C-GC	--	0.162	3-1/2	48	194	181	161	149	141	138	137	136	--	40	
SS	8d x 1-1/2	SSNA8D	SSN8	0.131	1-1/2	147	--	--	--	--	--	96	95	94	94	32	
	10d x 1-1/2	SSNA10D	SSN10	0.148	1-1/2	126	--	--	139	127	119	116	114	114	113	36	
	8d Common	SSN8C	SS8D	0.131	2-1/2	94	--	--	--	--	99	96	95	94	94	32	
	10d Common	SSN10C	SS10D	0.148	3	67	--	158	139	127	119	116	114	114	113	36	
	16d Common	SSN16C	SS16D	0.162	3-1/2	44	194	181	161	149	141	138	137	136	136	40	
Bright	8d Common	8d Common	--	0.131	2-1/2	126	--	--	--	--	99	96	95	94	94	32	
	10d Common	10d Common	--	0.148	3	70	--	158	139	127	119	116	114	114	113	36	
	16d Sinker	16d Sinker	--	0.148	3-1/4	60	162	158	139	127	119	116	114	114	--	36	
	16d Ring Shank	NA16D-RS	--	0.148	3-1/2	57	183	168	150	--	--	--	--	--	--	36	
	16d Common	16d Common	--	0.162	3-1/2	48	194	181	161	149	141	138	137	136	--	40	
	20d Common	20d Common	--	0.192	4	29	234	207	187	175	168	--	--	--	--	47	

- 1) Loads are calculated to specifications of Part 11 of the National Design Specifications for Wood Construction (NDS®), 2015 Edition.
- 2) Loads apply to Douglas Fir (G=0.50) and Southern Pine (G=0.55). For Spruce-Pine-Fir (G=0.42) multiply above values by 0.86, for other wood types refer to NDS® or consult MiTek.
- 3) HDG = Hot-Dip Galvanized; SS = Stainless Steel; GC = Gold Coat; Bright = No Finish.
- 4) For 3 gauge steel with Fu=58,000 psi and 7 gauge thru 22 gauge steel with Fu=45,000 psi. Shear values assumes full penetration of at least 10 nail diameters.
- 5) Fastener values may be increased for duration of load.
- 6) Withdrawal loads are in pounds (lbs) per linear inch of embedment into main member.
- 7) Bright finish common and sinker nails are listed in table for reference only. MiTek does not stock these type nails.

**Corrosion Finish** ■ Stainless Steel ■ Gold Coat ■ HDG ■ Triple Zinc

**Minimum Fastener Penetration Table**

Nail Penny	Wire Gauge	Shank Diameter (inches)	Minimum Penetration for Full Shear Load (inches)	Minimum Penetration for Reduced Shear Load <sup>2</sup> (inches)
6d	11-1/2	.113	1.13	0.68
8d	10-1/4	.131	1.31	0.79
10d	9	.148	1.48	0.89
12d	9	.148	1.48	0.89
16d Sinker	9	.148	1.48	0.89
16d	8	.162	1.62	0.97
20d	6	.192	1.92	1.15

- 1) Less than the specified nail penetration shall be multiplied by the applicable adjustment factor.
- 2) For penetration less than this distance, the nail has no value.
- 3) Penetrations are derived according to the 2018 NDS®.



**Reduced Fastener Penetration Example**  
(See chart above):

**HD210 (Min)** – listed load is 1540 lbs. @ 100% for 16d common nails.

**Reduced HD210 capacity if using a 2x DF-L or SP header:**

$$\frac{1540 \text{ lbs.} \times 1.5}{1.62} = 1425 \text{ lbs. @ 100\%}$$



## Fastening Identification / Features



**Round Holes:**  
 Always fill all (normal-size) round nail holes, unless otherwise noted.



**Diamond Holes:**  
 Optional nailing for maximum listed capacity or for temporary hanger fastening during installation.

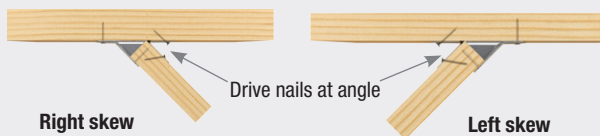
When there are **MIN** and **MAX** values:  
**MIN:** fill all round nail holes  
**MAX:** fill all round and diamond holes



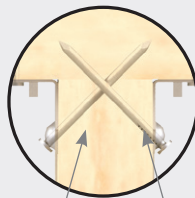
**Large Round Holes:**  
 For concrete/masonry installation; no need to be filled when connected to wood. Large round holes may be used for manufacturing which do not require a fastener. Verify fastener schedule in catalog.



**Obround Holes:**  
 For ease of nailing at a tight location; always fill.

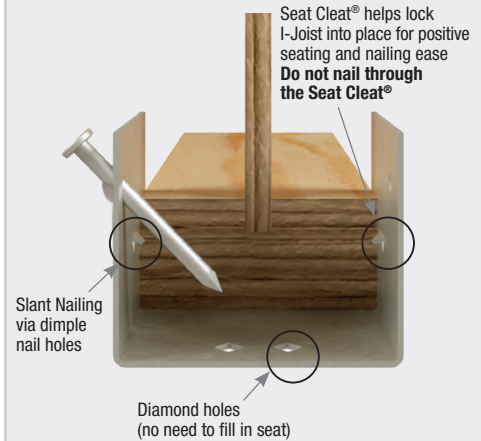


**Dimple Holes:**  
 Guide double shear nails into the joist and header at a 30° to 45° angle



Use specified standard length common nails. 16d common and 10d common nails are 3-1/2" and 3" long respectively.

### Typical I-Joist Nailing



### Common Nailing Errors



#### Wrong Angle

When a nail is driven into the bottom flange of the wood I-Joist parallel to the glue lines, separation of veneers can occur which substantially reduces the design loads of the connection.



#### Nail Too Long

When using nails longer than MiTek's recommended nails, bottom flange splitting may occur. Also, this can raise the wood I-Joist off the seat, resulting in uneven surfaces and squeaky floors along with reduced design load.



# MiTek® TECO™ 33° Collated Nails



MiTek® TECO™ 33° collated pneumatically driven nails feature a color coded head-ID stamp system that makes it easy to verify the proper nail has been used. The 33° collated nails can serve as an alternate to hand-driven installation of the following nails and may be used with many MiTek products.

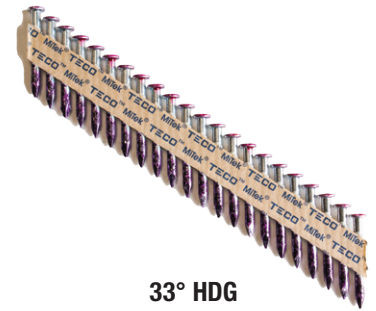
**Materials:** ASTM A580 (Bright) and ASTM A153 (HDG)

**Finish:** Bright, Hot-dip galvanized

**Codes:** See page 12 for Code Reference Chart

**Installation:**

- Can be used in a wide variety of pneumatic nail guns with nail locating ability.
- Follow manufacturer's instructions for proper use of gun and proper safety equipment.
- Install all specified fasteners per catalog.
- Do not overdrive nails.



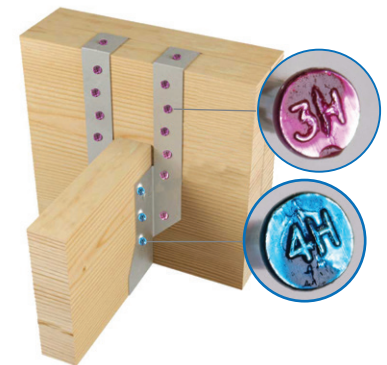
**33° HDG Collated Nails**



**33° Bright Collated Nails**

Finish <sup>1</sup>	Size	MiTek USP Stock No.	Ref. No.	Head ID	Dimensions (in)		Code Ref.
					Nail Diameter	Length	
HDG	8d x 1-1/2	NA8DHDGPT	N8HDGPT	A3	0.131	1-1/2	IBC, FL
	8d Common	N8CHDGPT	--	E3	0.131	2-1/2	
	10d x 1-1/2	NA10DHDGPT	--	A4	0.148	1-1/2	
	10d Common	N10CHDGPT	N10DHDGPT	E4	0.148	2-1/2	
	16d x 2-1/2	NA16DHDGPT	N16HDGPT	E6	0.162	2-1/2	
Bright	8d x 1-1/2	NA8DRPT	--	3H	0.131	1-1/2	
	8d Common	N8CRPT	--	3H	0.131	2-1/2	
	10d x 1-1/2	NA10DRPT	--	4H	0.148	1-1/2	
	10d Common	N10CRPT	--	4H	0.148	2-1/2	
	16d x 2-1/2	NA16DRPT	--	6H	0.162	2-1/2	

1) HDG = Hot-Dip Galvanized; Bright = No Finish.



**Typical MiTek hanger installation using TECO 33° Collated Nails**



Available in packs of 250, 800 & Bulk Packs

**Packaging Table**

Finish	Size	250-count Pack		800-count Pack		Bulk Offering	
		MiTek USP Stock No.	Box/Ctn Qty	MiTek USP Stock No.	Box/Ctn Qty	MiTek USP Stock No.	Box Qty
HDG	8d x 1-1/2	NA8DHDGPT250	4-pack/250-ea	NA8DHDGPT800	2-pack/800-ea	NA8DHDGPT4000	4000-ea
	8d Common	N8CHDGPT250	4-pack/250-ea	N8CHDGPT800	2-pack/800-ea	N8CHDGPT2500	2500-ea
	10d x 1-1/2	NA10DHDGPT250	4-pack/250-ea	NA10DHDGPT800	2-pack/800-ea	NA10DHDGPT3000	3000-ea
	10d Common	N10CHDGPT250	4-pack/250-ea	N10CHDGPT800	2-pack/800-ea	N10CHDGPT2500	2500-ea
	16d x 2-1/2	NA16DHDGPT250	4-pack/250-ea	NA16DHDGPT800	2-pack/800-ea	NA16DHDGPT2000	2000-ea
Bright	8d x 1-1/2	NA8DRPT250	4-pack/250-ea	NA8DRPT800	2-pack/800-ea	NA8DRPT4000	4000-ea
	8d Common	N8CRPT250	4-pack/250-ea	N8CRPT800	2-pack/800-ea	N8CRPT2500	2500-ea
	10d x 1-1/2	NA10DRPT250	4-pack/250-ea	NA10DRPT800	2-pack/800-ea	NA10DRPT3000	3000-ea
	10d Common	N10CRPT250	4-pack/250-ea	N10CRPT800	2-pack/800-ea	N10CRPT2500	2500-ea
	16d x 2-1/2	NA16DRPT250	4-pack/250-ea	NA16DRPT800	2-pack/800-ea	NA16DRPT2000	2000-ea

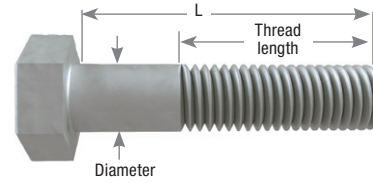
For customer convenience, we offer a wide range of bolts specified for the MiTek product line. Each bolt is shipped with two washers and one hex nut.

**Materials:** Bolts and nuts are standard hex head conforming to ASTM A 307 Grade A or SAE Grade 2 or better. Washers conform to American National Standard Type A plain steel, ANSI B.22.1.

**Finish:** Zinc plated

**Installation:**

- For installation into connectors in general, install with both washers unless otherwise directing in this catalog.



**Bolt Specification Table**

MiTek USP Stock No.	Description	Thread Length (in)
	Dia. x L (in)	
B384	3/8 x 4	1
B125	1/2 x 5	1-1/4
B126	1/2 x 6	1-1/4
B127	1/2 x 7	1-1/2
B128	1/2 x 8	1-1/2
B583	5/8 x 3	1-1/2
B584	5/8 x 4	1-1/2
B585	5/8 x 5	1-1/2
B586	5/8 x 6	1-1/2
B587	5/8 x 7	1-3/4
B588	5/8 x 8	1-3/4
B589	5/8 x 9	1-3/4
B5810	5/8 x 10	1-3/4
B343	3/4 x 3	1-3/4
B344	3/4 x 4	1-3/4
B345	3/4 x 5	1-3/4
B346	3/4 x 6	1-3/4
B347	3/4 x 7	2
B348	3/4 x 8	2
B349	3/4 x 9	2
B3410	3/4 x 10	2
B3411	3/4 x 11	2
B785	7/8 x 5	2
B786	7/8 x 6	2
B787	7/8 x 7	2-1/4
B788	7/8 x 8	2-1/4
B7810	7/8 x 10	2-1/4
B103	1 x 3	2-1/4
B104	1 x 4	2-1/4
B105	1 x 5	2-1/4
B106	1 x 6	2-1/4
B107	1 x 7	2-1/2
B108	1 x 8	2-1/2

**Metric Conversion**

Bolt Diameter Conversion	
Inches	Millimeters
3/8	9.50
1/2	12.70
5/8	15.90
3/4	19.10
7/8	22.20
1	25.40
1-1/8	28.58
1-1/4	31.75

The Gold Coat Hex Head can be used with a number of MiTek connectors as well as wood-to-wood and steel-to-wood connections. Head stamped to indicate length for easy inspection.

### Features and Benefits:

- 1/4" diameter
- No predrilling
- Comparable to 1/2" Lag Screw
- Type 17 point reduces installation torque and splitting
- 3/8" Hex Drive
- Length identification stamps on all heads

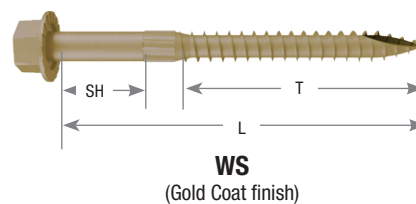
**Materials:** 1/4" diameter Grade 5 steel

**Finish:** Gold Coat

**Codes:** See page 12 for Code Reference Chart

### Installation:

- Screws are self-drilling.
- Install using a low speed clutch drill with 3/8" hex head driver. The washer head should be flat to the surface and the serrations will oppose turning and release the clutch. Do not over-tighten the screws.
- Installing the screw at an angle may introduce additional bending and tension forces into the fastener if the screw head is not flat on the bearing surface. Care should be given to ensure the fastener is installed perpendicular to the plane of the side plate.



**EXTENDED LIFE**  
**GOLD COAT**

### Specification Table

Size (in)	MiTek USP Stock No.	Ref. No.	Dimensions (in)				DF/SP Allowable Loads (Lbs.) <sup>2,4</sup>				S-P-F Allowable Loads (Lbs.) <sup>2,4</sup>				Code Ref.				
			L	SH	T	Finish <sup>1</sup>	Shear (100%)		Withdrawal Capacity (Lbs/in. of thread)	Steel to Wood Withdrawal Capacity (Lbs.) <sup>5</sup>	Shear (100%)		Withdrawal Capacity (Lbs/in. of thread)	Steel to Wood Withdrawal Capacity (Lbs.) <sup>5</sup>					
							Steel to Wood <sup>5</sup>				Steel to Wood <sup>5</sup>								
							Gauge				Gauge								
14	10	7	3	100%	100%	14	10	7	3	100%	100%								
1/4 x 1-1/2	WS15-GC	--	1-1/2	1/4	1-1/4	GC	230	261	259	266	164	206	188	211	190	217	103	129	IBC, FL, LA

1) GC = Gold Coat over Clear Zinc Trivalent.

2) Allowable shear loads assume a side plate tensile strength of 45 ksi for 14 gauge and 10 gauge, 52 ksi for 7 gauge and 58 ksi for 3 gauge.

3) Shear loads for wood-to-wood connections assume a side member thickness of 1-1/2".

4) Loads are for 100% duration of load factors, and may be increased for other duration factors in accordance with the NDS.

5) Withdrawal loads for steel-to-wood connections assume a side plate thickness of 1/4" or less.

### Packaging Table

Use	Size (in)	Retail Box Offering	
		MiTek USP Stock No.	Box/Ctn Qty
Exterior for Deck Ledgers & other wood-to-wood connections	1/4 x 1-1/2	WS15-GCR25	10-pack/25-ea

# WS Hex Head Interior Structural Wood Screws

The WS Wood Screw is a self-drilling screw used for numerous interior framing applications. For use in wood-to-wood and steel-to-wood applications. Head stamped to indicate length for easy inspection.

**Features and Benefits:**

- 1/4" diameter
- No predrilling
- Type 17 point reduces installation torque and splitting
- 3/8" Hex Drive
- Length identification stamps on all WS heads

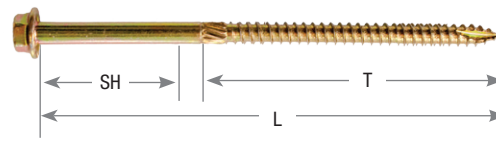
**Materials:** 1/4" diameter Grade 5 steel

**Finish:** Yellow Zinc

**Codes:** See page 12 for Code Reference Chart

**Installation:**

- Screws are self-drilling.
- Install using a low speed clutch drill with 3/8" hex head driver. The washer head should be flat to the surface and the serrations will oppose turning and release the clutch. Do not over-tighten the screws.
- Care should be given to ensure the fastener is installed perpendicular to the plane of the side plate.



**WS**  
(Yellow Zinc finish)



**Specification Table**

Size (in)	MiTek USP Stock No.	Ref. No.	Dimensions (in)				DF/SP Allowable Loads (Lbs.) <sup>2,4</sup>							S-P-F Allowable Loads (Lbs.) <sup>2,4</sup>							Code Ref.
			L	SH	T	Finish <sup>1</sup>	Shear (100%)				Wood to Wood <sup>3</sup>	Steel to Wood <sup>6</sup>	Withdrawal Capacity (Lbs/in of thread)	Steel to Wood Withdrawal Capacity (Lbs.) <sup>5</sup>	Shear (100%)				Withdrawal Capacity (Lbs/in. of thread)	Steel to Wood Withdrawal Capacity (Lbs.) <sup>5</sup>	
							Gauge								Gauge						
							14	10	7	3					14	10	7	3			
1/4 x 1-1/2	WS15	SDS1/4X1.5, SDS1/4X11/2	1-1/2	1/4	1-1/4	Zinc	--	230	261	259	266	164	206	--	188	211	190	217	103	129	IBC, FL, LA
1/4 x 2	WS2	SDS1/4X2	2	1/4	1-3/4	Zinc	--	306	307	289	316	160	281	--	215	244	249	248	117	204	
1/4 x 2-1/2	WS25	SDS1/4X2.5	2-1/2	1/4	2	Zinc	--	362	352	338	369	199	398	--	256	292	286	294	141	281	
1/4 x 3	WS3	SDS1/4X3	3	3/4	2	Zinc	268	418	396	387	457	199	398	227	297	340	322	365	141	281	
1/4 x 3-1/2	WS35	SDS1/4X3.5, SDS1/4X31/2	3-1/2	3/4	2-1/2	Zinc	400	451	460	454	481	208	520	311	338	380	356	370	154	385	
1/4 x 4-1/2	WS45	SDS1/4X4.5, SDS1/4X41/2	4-1/2	1-1/4	3	Zinc	415	516	588	589	531	214	642	364	421	460	425	379	163	489	
1/4 x 5	WS5	--	5	1-3/4	3	Zinc	415	516	588	589	531	214	642	364	421	460	425	379	163	489	
1/4 x 6	WS6	SDS1/4X6	6	1-3/4	4	Zinc	415	516	588	589	531	214	642	364	421	460	425	379	163	489	
1/4 x 8	WS8	--	8	4-3/4	3	Zinc	415	516	588	589	531	214	642	364	421	460	425	379	163	489	

1) Zinc = Yellow Zinc Dichromate.  
 2) Allowable shear loads assume a side plate tensile strength of 45 ksi for 14 gauge and 10 gauge, 52 ksi for 7 gauge and 58 ksi for 3 gauge.  
 3) Shear loads for wood-to-wood connections assume a side member thickness of 1-1/2".  
 4) Loads are for 100% duration of load factors, and may be increased for other duration factors in accordance with the NDS.  
 5) Withdrawal loads for steel-to-wood connections assume a side plate thickness of 1/4" or less.

**Packaging Table**

Use	Size (in)	Retail Box Offering		Mini Bulk Offering		Bulk Offering	
		MiTek USP Stock No.	Box/Ctn Qty	MiTek USP Stock No.	Box/Ctn Qty	MiTek USP Stock No.	Box/Ctn Qty
Interior for wood-to-wood connections	1/4 x 1-1/2	WS15-R25	12-pack/25-ea	WS15-MB	3-box/300-ea	WS15-BP	1500-ea
	1/4 x 2	WS2-R25	12-pack/25-ea	WS2-MB	3-box/250-ea	WS2-BP	1300-ea
	1/4 x 2-1/2	WS25-R25	12-pack/25-ea	WS25-MB	3-box/200-ea	WS25-BP	1100-ea
	1/4 x 3	WS3-R25	12-pack/25-ea	WS3-MB	3-box/150-ea	WS3-BP	950-ea
	1/4 x 3-1/2	WS35-R10	12-pack/10-ea	WS35-MB	3-box/125-ea	WS35-BP	900-ea
	1/4 x 4-1/2	WS45-R10	12-pack/10-ea	WS45-MB	3-box/100-ea	WS45-BP	800-ea
	1/4 x 5	WS5-R10	12-pack/10-ea	WS5-MB	3-box/100-ea	WS5-BP	500-ea
	1/4 x 6	WS6-R10	12-pack/10-ea	WS6-MB	3-box/100-ea	WS6-BP	600-ea
1/4 x 8	WS8-R10	12-pack/10-ea	--	--	WS8-BP	400-ea	

# WS Hex Head Exterior Structural Wood Screws

The MiTek Pro Series Hex Head is the ideal screw for numerous framing applications. It can be used in wood-to-wood and steel-to-wood applications.

**Features and Benefits:**

- 1/4" diameter
- No predrilling
- Type 17 point reduces installation torque and splitting
- 3/8" hex drive
- Length identification stamps on all WS heads

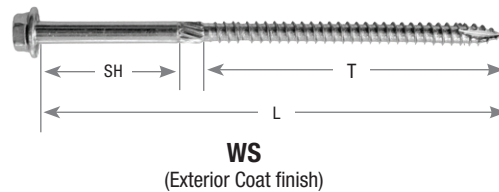
**Materials:** 1/4" diameter Grade 5 steel

**Finish:** Exterior Coat

**Codes:** See page 12 for Code Reference Chart

**Installation:**

- Screws are self-drilling.
- Install using a low speed clutch drill with 3/8" hex head driver. The washer head should be flat to the surface and the serrations will oppose turning and release the clutch. Do not over-tighten the screws.
- Care should be given to ensure the fastener is installed perpendicular to the plane of the side plate.
- Refer to WS series Technical Bulletin for attaching deck ledger to rim board.



**Specification Table**

Size (in)	MiTek USP Stock No.	Ref. No.	Dimensions (in)				Finish <sup>1</sup>	DF/SP Allowable Loads (Lbs.) <sup>2,4</sup>						S-P-F Allowable Loads (Lbs.) <sup>2,4</sup>						Code Ref.	
			L	SH	T	EXT		Shear (100%)				Withdrawal Capacity (Lbs./in. of thread)	Steel to Wood Withdrawal Capacity (Lbs.) <sup>5</sup>	Shear (100%)				Withdrawal Capacity (Lbs./in. of thread)	Steel to Wood Withdrawal Capacity (Lbs.) <sup>5</sup>		
								Steel to Wood <sup>6</sup>						Wood to Wood <sup>3</sup>	Steel to Wood <sup>6</sup>						
								Gauge							Wood to Wood <sup>3</sup>	Gauge					
14	10	7	3	100%	100%	14	10	7	3	100%	100%										
1/4 x 1-1/2	WS15-EXT	SDS25112	1-1/2	1/4	1-1/4	EXT	--	230	261	259	266	164	206	--	188	211	190	217	103	129	IBC, FL, LA
1/4 x 2	WS2-EXT	SDS25200	2	1/4	1-3/4	EXT	--	306	307	289	316	160	281	--	215	244	249	248	117	204	
1/4 x 2-1/2	WS25-EXT	SDS25212	2-1/2	1/4	2	EXT	--	362	352	338	369	199	398	--	256	292	286	294	141	281	
1/4 x 3	WS3-EXT	SDS25300	3	3/4	2	EXT	268	418	396	387	457	199	398	227	297	340	322	365	141	281	
1/4 x 3-1/2	WS35-EXT	SDS25312	3-1/2	3/4	2-1/2	EXT	400	451	460	454	481	208	520	311	338	380	356	370	154	385	
1/4 x 4-1/2	WS45-EXT	SDS25412	4-1/2	1-1/4	3	EXT	415	516	588	589	531	214	642	364	421	460	425	379	163	489	
1/4 x 5	WS5-EXT	SDS2500	5	1-3/4	3	EXT	415	516	588	589	531	214	642	364	421	460	425	379	163	489	
1/4 x 6	WS6-EXT	SDS25600	6	1-3/4	4	EXT	415	516	588	589	531	214	642	364	421	460	425	379	163	489	
1/4 x 8	WS8-EXT	SDS25800	8	4-3/4	3	EXT	415	516	588	589	531	214	642	364	421	460	425	379	163	489	

1) EXT = Exterior Coat.  
 2) Allowable shear loads assume a side plate tensile strength of 45 ksi for 14 gauge and 10 gauge, 52 ksi for 7 gauge and 58 ksi for 3 gauge.  
 3) Shear loads for wood-to-wood connections assume a side member thickness of 1-1/2".  
 4) Loads are for 100% duration of load factors, and may be increased for other duration factors in accordance with the NDS.  
 5) Withdrawal loads for steel-to-wood connections assume a side plate thickness of 1/4" or less.

**Packaging Table**

Use	Size (in)	Retail Box Offering		50-count Pack		Mini Bulk Offering		Bulk Offering	
		MiTek USP Stock No.	Box/Ctn Qty	MiTek USP Stock No.	Box/Ctn Qty	MiTek USP Stock No.	Box/Ctn Qty	MiTek USP Stock No.	Box Qty
Exterior for Deck Ledgers & other wood-to-wood connections	1/4 x 1-1/2	WS15-EXTR25	10-pack/25-ea	--	--	WS15-EXTMB	2-box/200-ea	WS15-EXTBP	1500-ea
	1/4 x 2	WS2-EXTR25	10-pack/25-ea	--	--	WS2-EXTMB	2-box/200-ea	WS2-EXTBP	1300-ea
	1/4 x 2-1/2	WS25-EXTR25	10-pack/25-ea	--	--	WS25-EXTMB	2-box/200-ea	WS25-EXTBP	1100-ea
	1/4 x 3	WS3-EXTR25	10-pack/25-ea	WS3-EXTR50	5-box/50-ea	WS3-EXTMB	200-ea	WS3-EXTBP	950-ea
	1/4 x 3-1/2	WS35-EXTR12	10-pack/12-ea	WS35-EXTR50	5-box/50-ea	WS35-EXTMB	200-ea	WS35-EXTBP	900-ea
	1/4 x 4-1/2	WS45-EXTR12	10-pack/12-ea	WS45-EXTR50	5-box/50-ea	WS45-EXTMB	200-ea	WS45-EXTBP	800-ea
	1/4 x 5	WS5-EXTR12	10-pack/12-ea	WS5-EXTR50	5-box/50-ea	WS5-EXTMB	200-ea	WS5-EXTBP	600-ea
	1/4 x 6	WS6-EXTR12	10-pack/12-ea	WS6-EXTR50	5-box/50-ea	WS6-EXTMB	200-ea	WS6-EXTBP	500-ea
1/4 x 8	WS8-EXTR12	10-pack/12-ea	WS8-EXTR50	5-box/50-ea	WS8-EXTMB	200-ea	--	--	

The MiTek Pro Series Washer Head is the ideal screw for interior Multi-Ply EWP and dimensional wood connections. The specific lengths of the WSWH allow for one-sided connections on multi-ply beams and girder trusses.

**Features and Benefits:**

- 1/4" diameter
- No predrilling
- Flat head style allows for less interference after installation
- Type 17 point reduces installation torque and splitting
- T30\* drive eliminates cam-out.
- Nibs under head seat head flush to wood surface
- Length identification stamps on all WSWH heads

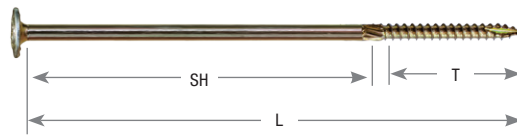
**Materials:** 1/4" diameter Grade 5 steel

**Finish:** Yellow zinc

**Codes:** See page 12 for Code Reference Chart

**Installation:**

- For best results, install the MiTek Pro Series Washer Head using a high torque, 1/2" variable speed drill (minimum 18v if cordless).
- Bring the washer portion of head flush to the surface of the wood.  
**Do not overdrive.**



**WSWH**  
(Yellow Zinc finish)



**Specification Table**

Size (in)	MiTek USP Stock No.	Ref. No.	Dimensions (in)			Finish <sup>1</sup>	DF/SP		SPF		LVL		Code Ref.
			L	SH	T		Allowable Loads (Lbs.) <sup>4</sup>		Allowable Loads (Lbs.) <sup>4</sup>		Allowable Loads (Lbs.) <sup>4</sup>		
							Wood-to-Wood	Wood-to-Wood	Wood-to-Wood	Wood-to-Wood	Wood-to-Wood	Wood-to-Wood	
<b>Wood-to-Wood Connections</b>													
1/4 x 2-7/8	WSWH278	SDW22300	2-7/8	5/8	2	Zinc	268	274	227	194	--	--	IBC, FL, LA
1/4 x 4-1/2	WSWH45	SDW22458	4-1/2	2-1/4	2	Zinc	415	398	364	282	358	382	
1/4 x 5	WSWH5	SDW22500	5	2-3/4	2	Zinc	415	398	364	282	358	382	
1/4 x 6	WSWH6	SDW22600	6	3-3/4	2	Zinc	415	398	364	282	358	382	
<b>Multi-Ply EWP Connections</b>													
1/4 x 3-3/8	WSWH338	SDW22338	3-3/8	1-1/8	2	Zinc	268	373	227	264	319	310	IBC, FL, LA
1/4 x 5	WSWH5	SDW22500	5	2-3/4	2	Zinc	415	398	364	282	358	382	
1/4 x 6-3/4	WSWH634	SDW22634	6-3/4	4-1/2	2	Zinc	415	398	364	282	358	382	
<b>Multi-Ply Dimensional Connections</b>													
1/4 x 2-7/8	WSWH278	SDW22300	2-7/8	5/8	2	Zinc	268	274	227	194	--	--	IBC, FL, LA
1/4 x 4-1/2	WSWH45	SDW22458	4-1/2	2-1/4	2	Zinc	415	398	364	282	358	382	
1/4 x 6	WSWH6	SDW22600	6	3-3/4	2	Zinc	415	398	364	282	358	382	
1/4 x 6-3/8	WSWH638	SDW22638	6-3/8	4-1/8	2	Zinc	415	398	364	282	358	382	

1) Zinc = Yellow Dichromate.  
 2) Shear load for wood-to-wood connections assume a side member thickness of 1-1/2" for DF/SP and SPF allowable loads and 1-3/4" for LVL Allowable Loads.  
 3) Withdrawal loads are derived from the minimum of head pull through tests and withdrawal capacity of threaded portion in main member.  
 4) Load are for 100% duration of load, and may be increased for the other duration factors in accordance the NDS.  
 New products or updated product information are designated in **blue font**.

**Packaging Table**

Use	Size (in)	50-count Pack		Mini Bulk Offering		Bulk Offering	
		MiTek USP Stock No.	Box/Ctn Qty	MiTek USP Stock No.	Box/Ctn Qty	MiTek USP Stock No.	Box Qty
Interior for Multi-Ply EWP & Multi-Ply Truss Girders	1/4 x 2-7/8	WSWH278-R50	5-box/50-ea	--	--	WSWH278-BP	500-ea
	1/4 x 3-3/8	WSWH338-R50	5-box/50-ea	WSWH338-MB	200-ea	--	--
	1/4 x 4-1/2	WSWH45-R50	5-box/50-ea	--	--	WSWH45-BP	400-ea
	1/4 x 5	WSWH5-R50	5-box/50-ea	WSWH5-MB	200-ea	--	--
	1/4 x 6	WSWH6-R50	5-box/50-ea	--	--	WSWH6-BP	300-ea
	1/4 x 6-3/8	WSWH638-R50	5-box/50-ea	--	--	WSWH638-BP	300-ea
	1/4 x 6-3/4	WSWH634-R50	5-box/50-ea	WSWH634-MB	200-ea	--	--

\* T30 is a trademark of Acument

The WSWH is an ideal alternative for the Pro or DIYer to traditional lag screws and through-bolts. It is easy to install and reduces labor on the jobsite. The large, flat washer head maximizes bearing area and allows for less interference after installation. Ideal for deck ledgers and more.

### Features and Benefits:

- 1/4" diameter
- No predrilling
- Flat head style allows for less interference after installation
- Type 17 point reduces installation torque and splitting
- T30\* drive eliminates cam-out.
- Large washer maximizes bearing area
- Nibs under head seat head flush to wood surface
- Length identification stamps on all WSWH heads

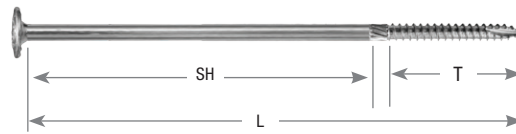
**Materials:** 1/4" diameter Grade 5 steel

**Finish:** Exterior Coat

**Codes:** See page 12 for Code Reference Chart

### Installation:

- For best results, install the MiTek Pro Series Washer Head using a high torque, 1/2" variable speed drill (minimum 18v if cordless). Bring the washer portion of head flush to the surface of the wood. Do not overdrive. For attaching Deck Ledger, Ledger-to-Studs, Multi-Ply Dimensional or EWP members see pages 33-38.



### Specification Table

Size (in)	MiTek USP Stock No.	Ref. No.	Dimensions (in)			Finish <sup>1</sup>	DF/SP		SPF		LVL		Code Ref.
			L	SH	T		Allowable Loads (Lbs.) <sup>4</sup>		Allowable Loads (Lbs.) <sup>4</sup>		Allowable Loads (Lbs.) <sup>4</sup>		
							Wood-to-Wood	Wood-to-Wood	Wood-to-Wood	Wood-to-Wood	Wood-to-Wood	Wood-to-Wood	
						Shear <sup>2</sup> 100%	Withdrawal <sup>3</sup> 100%	Shear <sup>2</sup> 100%	Withdrawal <sup>3</sup> 100%	Shear <sup>2</sup> 100%	Withdrawal <sup>3</sup> 100%		
<b>Deck Ledger and Other Wood-to-Wood Connections</b>													
1/4 x 2-7/8	WSWH278-EXT	SDW22300	2-7/8	5/8	2	EXT	268	274	227	194	--	--	IBC, FL, LA
1/4 x 3-5/8	WSWH358-EXT	--	3-5/8	1-3/8	2	EXT	400	398	311	282	319	358	
1/4 x 4-1/2	WSWH45-EXT	SDW22458	4-1/2	2-1/4	2	EXT	415	398	364	282	358	382	
1/4 x 5	WSWH5-EXT	SDW22500	5	2-3/4	2	EXT	415	398	364	282	358	382	
1/4 x 6	WSWH6-EXT	SDW22600	6	3-3/4	2	EXT	415	398	364	282	358	382	
1/4 x 8	WSWH8-EXT	SDWS22800	8	5-3/4	2	EXT	415	398	364	282	358	382	

1) EXT = Exterior Coat.

2) Shear load for wood-to-wood connections assume a side member thickness of 1-1/2" for DF/SP and SPF allowable loads and 1-3/4" for LVL Allowable Loads.

3) Withdrawal loads are derived from the minimum of head pull through tests and withdrawal capacity of threaded portion in main member.

4) Load are for 100% duration of load, and may be increased for the other duration factors in accordance the NDS.

New products or updated product information are designated in **blue font**.

### Packaging Table

Use	Size (in)	Retail Box Offering		50-count Pack		Mini Bulk Offering	
		MiTek USP Stock No.	Box/Ctn Qty	MiTek USP Stock No.	Box/Ctn Qty	MiTek USP Stock No.	Box/Ctn Qty
Exterior for Deck Ledgers & other wood-to-wood connections	1/4 x 2-7/8	WSWH278-EXTR25	10-pack/25-ea	WSWH278-EXTR50	5-box/50-ea	WSWH278-EXTMB	200-ea
	1/4 x 3-5/8	WSWH358-EXTR12	10-pack/12-ea	WSWH358-EXTR50	5-box/50-ea	WSWH358-EXTMB	200-ea
	1/4 x 4-1/2	WSWH45-EXTR12	10-pack/12-ea	WSWH45-EXTR50	5-box/50-ea	WSWH45-EXTMB	200-ea
	1/4 x 5	WSWH5-EXTR12	10-pack/12-ea	WSWH5-EXTR50	5-box/50-ea	WSWH5-EXTMB	200-ea
	1/4 x 6	WSWH6-EXTR12	10-pack/12-ea	WSWH6-EXTR50	5-box/50-ea	WSWH6-EXTMB	200-ea
	1/4 x 8	WSWH8-EXTR12	10-pack/12-ea	WSWH8-EXTR50	5-box/50-ea	WSWH8-EXTMB	200-ea

\* T30 is a trademark of Acument

The WSBH is a multi-purpose structural wood screw ideal for a low profile appearance in wood-to-wood connections. This structural wood screw allows the Pro Contractor or DIYer to drive the head flush or countersink it below the wood surface. The WSBH is easy to install and a high strength alternative to traditional lags, bolts and pole barn nails.

### Features and Benefits:

- 1/4" diameter
- No predrilling
- Comparable to 1/2" Lag Screw
- Low profile head style can be driven flush or countersunk
- Type 17 point reduces installation torque and splitting
- T30\* drive eliminates cam-out.
- Length identification stamps on all WSBH heads

**Materials:** 1/4" diameter Grade 5 steel

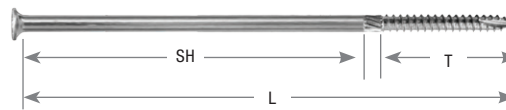
**Finish:** Exterior Coat

**Options:** See chart for Corrosion Finish Options

**Codes:** See page 12 for Code Reference Chart

### Installation:

- For best results, install the MiTek Pro Series Bugle Head using a high torque, 1/2" variable speed drill (minimum 18v if cordless). Bring the washer portion of head flush to the surface of the wood or countersink.



**WSBH**  
(Exterior Coat Finish)



### Specification Table

Size (in)	MiTek USP Stock No.	Ref. No.	Dimensions (in)			Finish <sup>1</sup>	DF/SP		SPF		LVL		Code Ref.
			L	SH	T		Allowable Loads (Lbs.) <sup>4</sup>		Allowable Loads (Lbs.) <sup>4</sup>		Allowable Loads (Lbs.) <sup>4</sup>		
							Wood to Wood	Wood to Wood	Wood to Wood	Wood to Wood			
							Shear <sup>2</sup> 100%	Withdrawal <sup>3</sup> 100%	Shear <sup>2</sup> 100%	Withdrawal <sup>3</sup> 100%	Shear <sup>2</sup> 100%	Withdrawal <sup>3</sup> 100%	
1/4 x 2-1/2	WSBH25-EXT	--	2-1/2	1/4	2	EXT	179	199	151	141	--	--	
1/4 x 4	WSBH4-EXT	--	4	1-3/4	2	EXT	316	282	246	208	252	339	IBC, FL, LA
1/4 x 6	WSBH6-EXT	--	6	3-3/4	2	EXT	328	282	288	208	283	339	
1/4 x 8	WSBH8-EXT	--	8	5-3/4	2	EXT	328	282	288	208	283	339	
1/4 x 10	WSBH10-EXT	--	10	7-3/4	2	EXT	328	282	288	208	283	339	

1) EXT = Exterior Coat.

2) Shear load for wood-to-wood connections assume a side member thickness of 1-1/2" for DF/SP and SPF allowable loads and 1-3/4" for LVL Allowable Loads.

3) Withdrawal loads are derived from the minimum of head pull through tests and withdrawal capacity of threaded portion in main member.

4) Load are for 100% duration of load, and may be increased for the other duration factors in accordance the NDS.

### Packaging Table

Use	Size (in)	Retail Box Offering		50-count Pack		Mini Bulk Offering	
		MiTek USP Stock No.	Box/Ctn Qty	MiTek USP Stock No.	Box/Ctn Qty	MiTek USP Stock No.	Box/Ctn Qty
Exterior for General Purpose wood-to-wood connections	1/4 x 2-1/2	WSBH25-EXTR25	10-pack/25-ea	WSBH25-EXTR50	5-box/50-ea	WSBH25-EXTMB	2-box/200-ea
	1/4 x 4	WSBH4-EXTR12	10-pack/12-ea	WSBH4-EXTR50	5-box/50-ea	WSBH4-EXTMB	200-ea
	1/4 x 6	WSBH6-EXTR12	10-pack/12-ea	WSBH6-EXTR50	5-box/50-ea	WSBH6-EXTMB	200-ea
	1/4 x 8	WSBH8-EXTR12	10-pack/12-ea	WSBH8-EXTR50	5-box/50-ea	WSBH8-EXTMB	200-ea
	1/4 x 10	WSBH10-EXTR12	10-pack/12-ea	WSBH10-EXTR50	5-box/50-ea	WSBH10-EXTMB	200-ea

\* T30 is a trademark of Acument

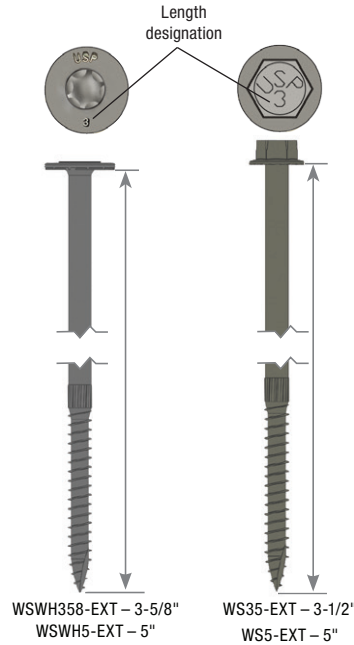


**Attaching Deck Ledger to Rim Board Using MiTek USP WS Series Wood Screws**

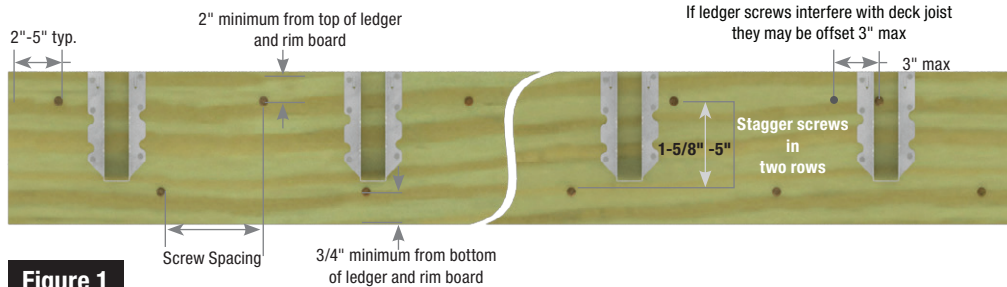
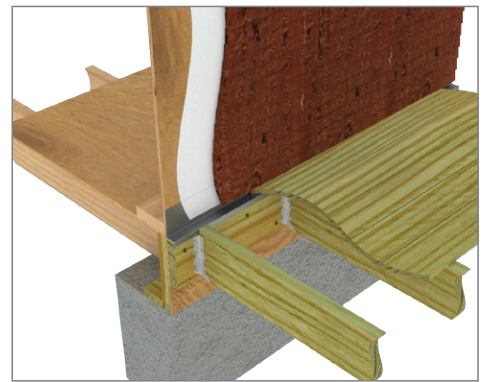
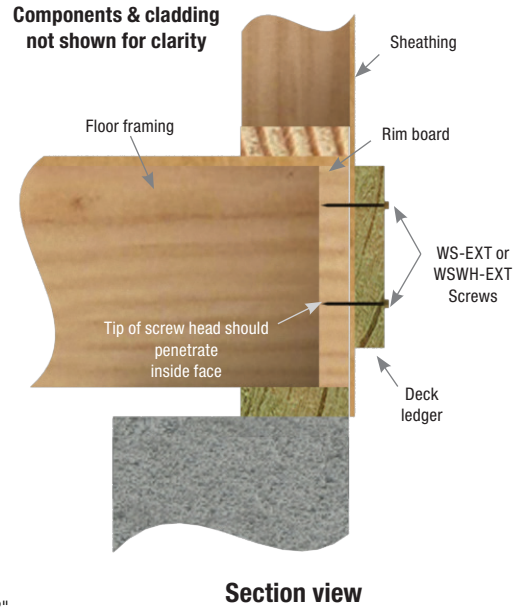
The MiTek USP WS series wood screws can be used to fasten deck ledgers to the rim board (AKA band/rim joist) of structures to meet the connection requirements of the International Residential Building Code (IRC). Both the standard hex head (WS-EXT) and washer head (WSWH-EXT) styles may be used for this purpose. Table R507.2 of the 2015 IRC calls out lag screws for deck ledger attachment and the WS-EXT and WSWH-EXT may be used in place of the lag screws.

**Installation:**

1. Select the proper WS-EXT or WSWH-EXT screw length. The threads should have full engagement with the rim board with the tip of the screw protruding and visible beyond the inside face of the rim board member. See Section View image.
2. With appropriate screw length selected, drive the screw through the ledger, sheathing, and rim board with a high torque variable speed drill.
3. Drive screw so head is firm and flush with surface of deck ledger, but do not overdrive.
4. Repeat these steps and install the appropriate number of screws at the prescribed edge, end distance, and spacing as called out in the table and Figure 1.



**Head markings for identification**



**Figure 1**

MiTek USP Stock No.	Live Load	Ledger	Rim Board	Spacing between WS-EXT / WSWH-EXT Screws based on Joist Span (in)						
				≤ 6-ft	≤ 8-ft	≤ 10-ft	≤ 12-ft	≤ 14-ft	≤ 16-ft	≤ 18-ft
WS35-EXT	40 psf	DF-L / SP / SPF	2" Nominal Solid Sawn	23	17	13	11	10	8	7
WSWH358-EXT			1" Min EWP	22	16	12	11	9	7	7
WS5-EXT	60 psf	DF-L / SP / SPF	2" Nominal Solid Sawn	16	12	9	7	7	5	5
WSWH5-EXT			1" Min EWP	15	11	8	7	6	5	5

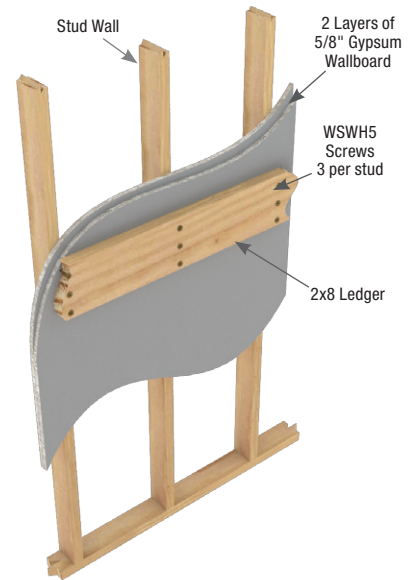
- 1) Numbers are based on use of 3-1/2", 3-5/8" and 5" length screws. 6" length screws (WS6-EXT or WSWH6-EXT) may be used with no reduction.
- 2) Screw spacing based on requirements of 2015 IRC Section R507.2 and Table R507.2 and equivalent spacing of 1/2" diameter lag bolts. Stagger screws into 2 rows.
- 3) Multiple ledger plies should be fastened together to act as one unit independent of the WS-EXT or WSWH-EXT ledger attachment screws.
- 4) Solid Sawn Rim Board shall be Douglas Fir-Larch (DF-L), Southern Pine (SP), or Spruce-Pine-Fir (SPF).

MiTek's WSWH Washer Head Screw can be used to attach a ledger to studs directly, through 1/2" apa rated sheathing or through one or two layers of 5/8" gypsum wallboard (drywall). Screws are to be installed into the wide face of the single 2x ledger, through the gypsum board and into the center of the narrow face of the 2x stud.

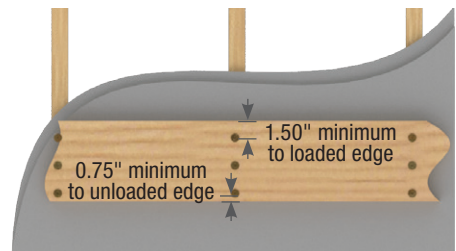
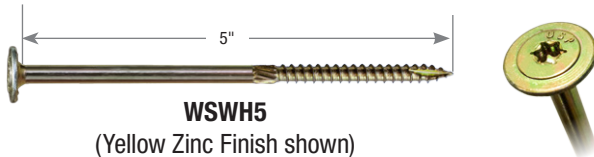
Fasteners

**Installation:**

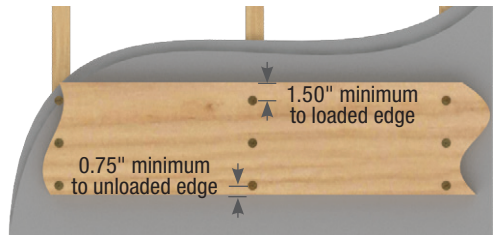
- Ledger design to be performed by a certified design professional.
- Locate studs in wall where ledger is to be installed.
- Install WSWH5 screws through ledger and 5/8" gypsum wallboard into wall framing using a T30 Torx bit.
- Follow the minimum edge distance guidelines in images shown below.
- Wall design must be performed by certified design professional.
- Care should be taken to install the ledger only where studs are plumb and free of any defects.
- **WSWH45 should be used when no gypsum wallboard is present.**



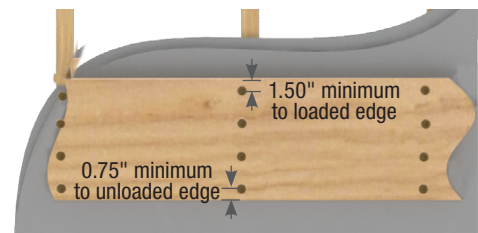
**Typical 2x8 Ledger attached through 2 layers of 5/8" Gypsum Wallboard installation**



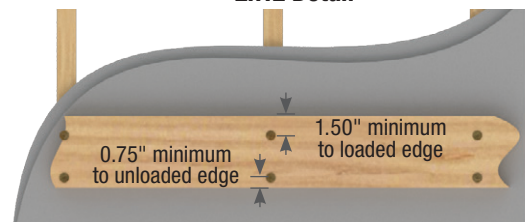
**2x8 Detail**



**2x10 Detail**



**2x12 Detail**



**2x6 Detail**

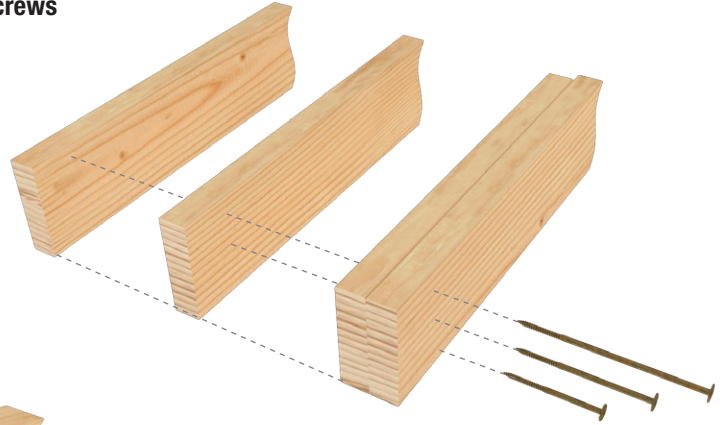
MiTek USP Stock No.		Ledger Size <sup>9</sup>	Number of Screws per Stud <sup>4,8</sup>	Allowable Shear Per Stud (Lbs.) <sup>2,5,6,7</sup>	
Zinc Finish <sup>1</sup>	EXT Finish <sup>1</sup>			DF/SP SG ≥ 0.50	S-P-F/HF 0.42 ≤ SG < 0.50
WSWH45	WSWH45-EXT	2x6	2	520	455
WSWH5	WSWH5-EXT	2x8 or 2x10	3	860	750
		2x12	4	1040	900

- 1) Zinc = Yellow Zinc Dichromate; EXT = Exterior Coat.
- 2) Allowable Loads are based on DF or equivalent wood members with a specific gravity of 0.50, or SPF/HF members with specific gravity in the following range: 0.42 ≤ SG < 0.50.
- 3) Gypsum board must be attached per building code requirements.
- 4) Screws must be installed in the center of the 2x stud, with a tolerance of 3/16" to either side. Minimum loaded end distance for the stud is 3" and 6" when loaded away from the end. Ledger end distance must be 6" or greater for full values. For ledger end distances between 2" and 6" use 50% of the load table, for end distance between 2" and 4" predrill with a 5/32" bit.
- 5) The values above can be used when designing a ledger connection with (1) or (2) layers of 5/8" gypsum board as well as direct connection with no gypsum between the ledger and studs as well as a single layer of APA rated 1/2" OSB.
- 6) Allowable loads are shown above at a load duration factor of CD = 1.00. Loads may be increased where applicable to the current NDS. When in-Service moisture content is greater than 19%, use Cm = 0.70.
- 7) For LRFD values, the values above should be adjusted in accordance with the 2015 NDS, Section 10.3.
- 8) Main members (stud) shall be loaded parallel to grain with a minimum penetration of 2-1/4" while side members (ledger) shall be loaded perpendicular to grain with a minimum penetration of 1-1/2".
- 9) For 2x10 ledger members with 3 screws, use 2x8 values. Spacing and edge distances shown in the illustrations are minimum values.

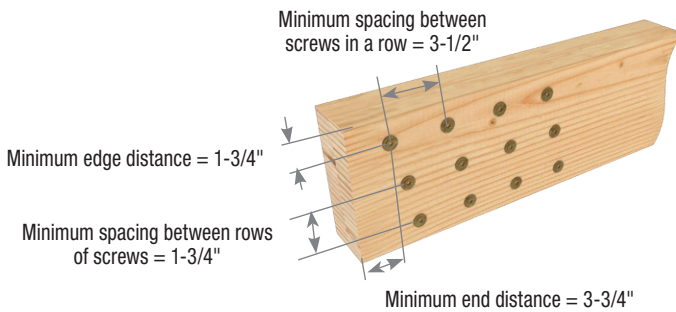
\* T30 is a trademark of Acument

**Joining Multi-Ply Dimensional Lumber Beams with WSWH Screws**

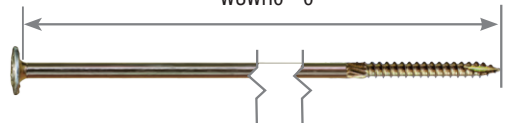
The MiTek Pro Series USP WSWH Wood Screws have been designed specifically for use in joining wood members of multiple-ply dimensional lumber beams. Using a standard 1/2" low speed/high torque drill, install screws into the side of the outermost ply. As the threads fully engage the final ply, allow the underside of the washer head to pull the plies firmly together. Washer head will install flush with the surface of the wood, but do not overdrive as this may damage the beam. Refer to the information in this bulletin for proper WSWH screw size selection and fastening pattern.



**Minimum Spacing Requirements:**



WSWH278 – 2-7/8"  
 WSWH45 – 4-1/2"  
 WSWH6 – 6"

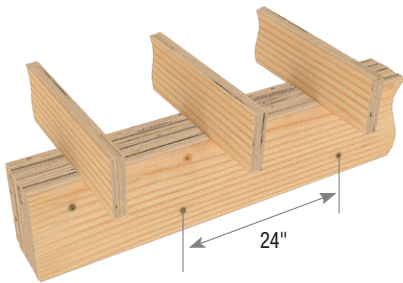


**Fastener Identification**

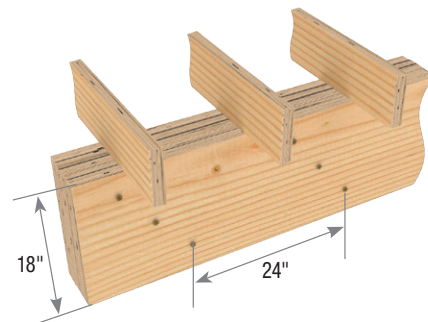
For easier selection and post installation inspection, all MiTek Pro-Series Wood Screws carry an identifying head marking.

**Top Loaded Beams**

Where floor joists rest on all plies of the beam, WSWH screws should be installed in two staggered rows at 24" O.C. spacing. Maintain the minimum end and edge distance as indicated above.



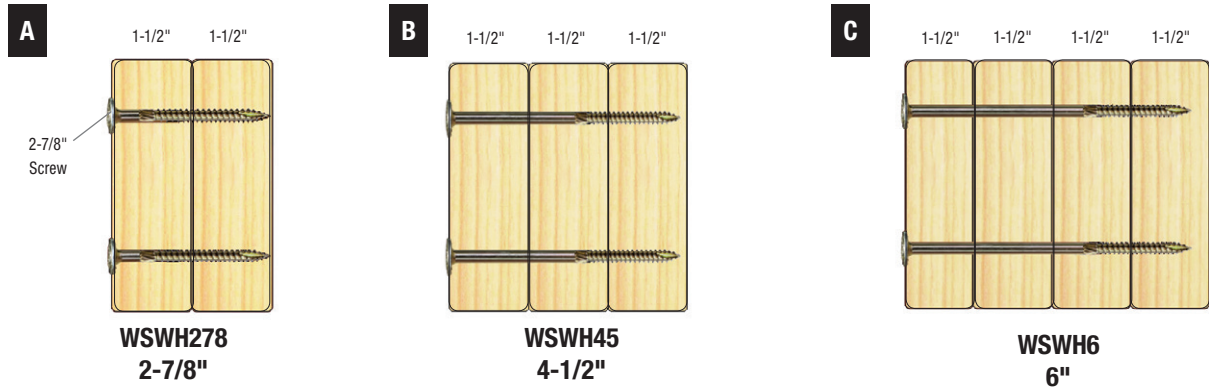
For beam depths of 18" or more, this pattern should be increased to three staggered rows of WSWH screws every 24" on center.



**General Guidelines:**

- Excessively warped or curved lumber should never be forced into alignment by use of clamps, screws or bolts as splitting may occur, potentially decreasing the carrying capacity of the beam.
- The WSWH278, WSWH45, and WSWH6 are not designed for use with engineered wood. Refer to MiTek's Joining Multiple Member (Multi-ply) Engineered Wood (EWP) Beams Technical Bulletin as a guide for selecting the proper length wood screw for that application.
- A qualified designer or engineer should always be consulted for critical assemblies and fastening requirements.

**Fastener Size Selection by Assembly Type**  
(2 rows shown)



**Side Loaded Beams**

Where floor joists are joined to the side of the beam (typically using a joist hanger), this load chart must be used to establish the proper pattern based on the design load as determined by the engineer and noted on the plans.

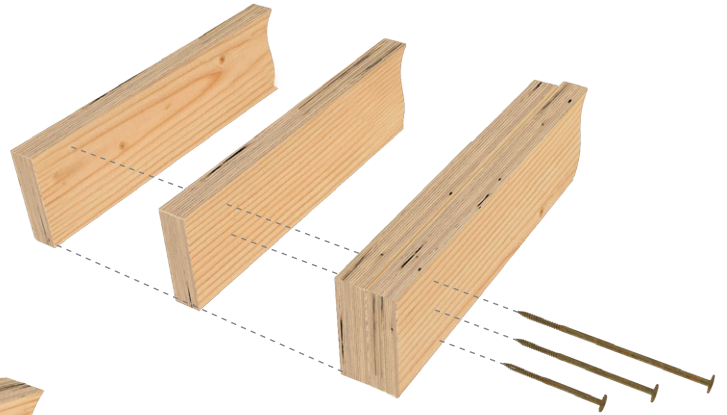
Length (in)	MiTek USP Stock No.	No. of Screws Vertical Column	Spacing Between Screws in a Row (in)	Allowable Side Loads by Assembly Type (Lbs/Lineal Ft) (See Graphics) <sup>1,2,3,4,5,6</sup>					
				DF/SP			SPF		
				A	B	C	A	B	C
2-7/8	WSWH278	2	24	535			455		
			19.2	670	--	--	570	--	--
			16	805			680		
		3	24	805			680		
			19.2	1005	--	--	850	--	--
			16	1205			1020		
4-1/2	WSWH45	2	24		625			545	
			19.2	--	780	--	--	685	--
			16		935			820	
		3	24		935			820	
			19.2	--	1165	--	--	1025	--
			16		1400			1230	
6	WSWH6	2	24			555			485
			19.2	--	--	690	--	--	605
			16			830			730
		3	24			830			730
			19.2	--	--	1040	--	--	910
			16			1245			1090

- 1) Allowable loads are derived from tested fastener values as reported in ICC-ES ESR-2761. (Visit [icc-es.org](http://icc-es.org))
- 2) All numbers in this table are based on Douglas Fir-Larch (DF), Southern Pine (SP), and Spruce-Pine-Fir (SPF).  
The DF/SP values are based on  $SG \geq 0.50$ . The SPF values are based on  $0.42 \leq SG \leq 0.50$ .
- 3) The uniform loads in this table relate only to the capacity of the fastener to transfer shear loads between plies.  
The capacity of the beam may be less and should be verified by design professional.
- 4) Values listed reflect 100% load duration. (CD=1.0) The designer may apply adjustment factors to increase or decrease these loads per the National Design Specification for Wood (NDS) based on conditions for each assembly.
- 5) To minimize rotation, 6" wide beams shall be side loaded only when loads are applied to both sides of the beam with the lesser loaded side bearing at least 25% of the overall design load.
- 6) Load values depicted assume all uniform load is applied to the outermost ply or point of entry for the screw.
- 7) **Tip side loading to beam is allowed for 50% of listed allowable side load. Head side and tip side of beam can be loaded concurrently so long as they do not exceed listed capacity. (Example: A 3 ply assembly with a head side load of 1,400 plf and tip side load of 700 plf may be fastened together with 3 rows of WSWH screws at 16" OC spacing between fasteners in a row).**

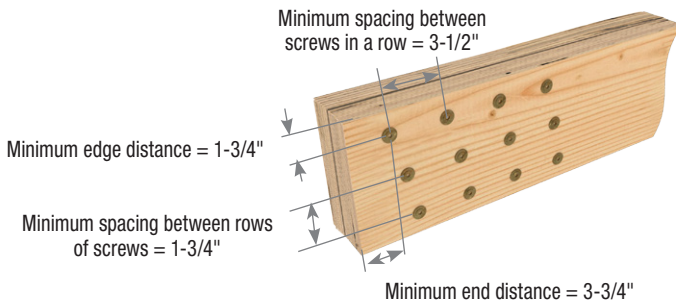
New products or updated product information are designated in **blue font**.

**Joining Multi-ply Engineered Wood (EWP) Beams with WSWH Screws**

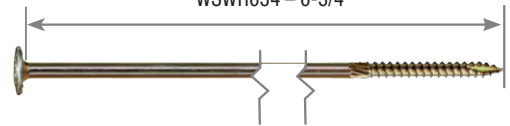
The MiTek Pro-Series USP WSWH Wood Screws have been designed specifically for use in joining wood members of multiple-ply engineered wood beams (LVL, LSL & PSL). Using a standard 1/2" low speed/high torque drill, install screws into the side of the outermost ply. As the threads fully engage the final ply, allow the underside of the washer head to pull the plies firmly together. Washer head will install flush with the surface of the wood, but do not overdrive as this may damage the beam. Refer to the information in this bulletin for proper WSWH screw size selection and fastening pattern.



**Minimum Spacing Requirements:**



WSWH338 – 3-3/8"  
 WSWH5 – 5-1/2"  
 WSWH634 – 6-3/4"

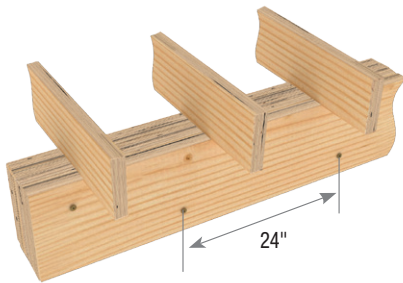


**Fastener Identification**

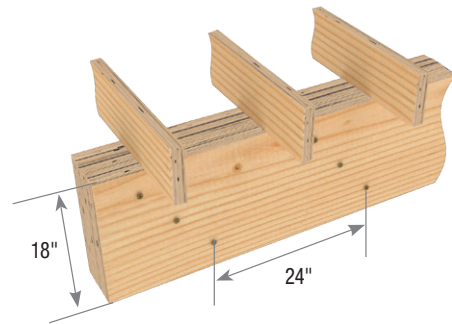
For easier selection and post installation inspection, all MiTek Pro-Series Wood Screws carry an identifying head marking.

**Top Loaded Beams**

Where floor joists rest on all plies of the beam, WSWH screws should be installed in two staggered rows at 24" O.C. spacing. Maintain the minimum end and edge distance as indicated above.



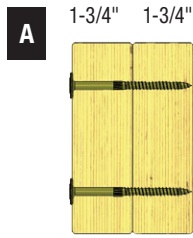
For beam depths of 18" or more, this pattern should be increased to three staggered rows of WSWH screws every 24" on center.



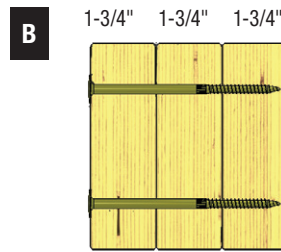
**General Guidelines:**

- Beams wider than 7" require special consideration by the design professional. The values on the next page do not apply.
- Excessively warped or curved LVL should never be forced into alignment by use of clamps, screws or bolts as splitting may occur, potentially decreasing the carrying capacity of the beam.
- The WSWH338, WSWH5, and WSWH634 are not designed for use with dimensional lumber. Refer to MiTek's Joining Multiple Member (Multi-ply) Dimensional Lumber Wood Beams Technical Bulletin as a guide for selecting the proper length wood screw for that application.
- A qualified designer or engineer should always be consulted for critical assemblies and fastening requirements.

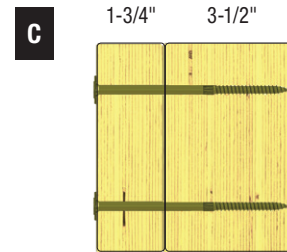
**Fastener Size Selection by Assembly Type (2 rows shown)**



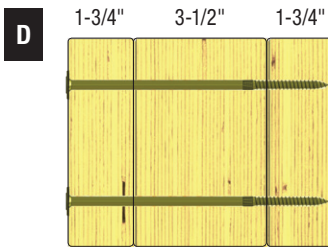
**WSWH338**  
3-3/8"



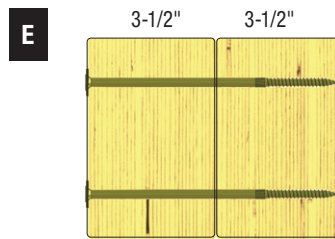
**WSWH5**  
5"



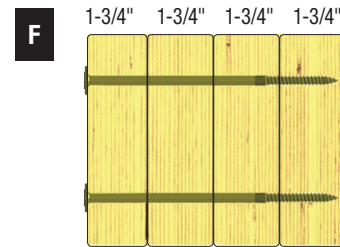
**WSWH5**  
5"



**WSWH634**  
6-3/4"



**WSWH634**  
6-3/4"



**WSWH634**  
6-3/4"

**Side Loaded Beams**

Where floor joists are joined to the side of the beam (typically using a joist hanger), this load chart must be used to establish the proper pattern based on the design load as determined by the engineer and noted on the plans.

Length (in)	MiTek USP Stock No.	No. of Screws Vertical Column	Spacing Between Screws in a Row (in)	Allowable Side Loads													
				by Assembly Type (Lbs/Lineal Ft) (See Graphics) <sup>1,2,3,4,5</sup>													
				EWP Wood Specific Gravity G=0.50						EWP Wood Specific Gravity G=0.42							
				A	B	C	D	E	F	A	B	C	D	E	F		
3-3/8	WSWH338	2	24	640							455						
			19.2	800	--	--	--	--	--		570	--	--	--	--	--	
			16	955							680						
		3	24	12	1275							910					
				19.2	955							680					
				16	1195	--	--	--	--	--		850	--	--	--	--	--
			12	1435							1020						
				1915							1360						
5	WSWH5	2	24		535	535						545	545				
			19.2	--	670	670	--	--	--		685	685	--	--	--		
			16		805	805					820	820					
		3	24	12		1075	1075					1090	1090				
				19.2		805	805					820	820				
				16	--	1005	1005	--	--	--		1025	1025	--	--	--	
			12	1210	1210						1230	1230					
				1610	1610						1640	1640					
6-3/4	WSWH634	2	24				475	715	475				485	730	485		
			19.2				595	895	595				605	910	605		
			16	--	--	--	715	1075	715	--	--	--	730	1090	730		
		3	24	12				955	1430	955				970	1455	970	
				19.2				715	1075	715				730	1090	730	
				16	--	--	--	895	1345	895	--	--	--	910	1365	910	
			12	1075	1610	1075					1090	1640	1090				
				1430	2150	1430					1455	2185	1455				

- 1) Allowable loads are derived from tested fastener values as reported in ICC-ES ESR-2761. (Visit icc-es.org)
  - 2) The uniform loads in this table relate only to the capacity of the fastener to transfer shear loads between plies. The specific gravity (SG) and the capacity of the EWP should be verified with manufacturer's literature.
  - 3) Values listed reflect 100% load duration. (CD=1.0) The designer may apply adjustment factors to increase or decrease these loads per the National Design Specification for Wood (NDS) based on conditions for each assembly.
  - 4) Load values depicted assume all uniform load is applied to the outermost ply or point of entry for the screw.
  - 5) To minimize rotation, 7" wide beams shall be side loaded only when loads are applied to both sides of the beam with the lesser loaded side bearing at least 25% of the overall design load.
- New products or updated product information are designated in **blue font**.

# LL LumberLok Exterior Structural Connector Screws

The LumberLok Exterior Structural Connector Screw is a self-drilling screw that can be used with a number of MiTek connectors and also for wood-to-wood applications. The screws feature a T20\* drive head with integral washer and gimlet point for ease of installation. The twin-lead threads drive in twice as fast as the single lead threads significantly reducing installation time. The USP head stamp identifies the screw length for easy inspection.

Screw shear capacities are based on a diameter of 0.162" when the shear plane is on the screw shank (SH) and 0.109" when the shear plane is on the threads (T). MiTek LumberLok Exterior Structural Connector Screws have a bending yield strength of 180,000 psi.

**Materials:** Low carbon hardened steel.

**Finish:** Gold Coat

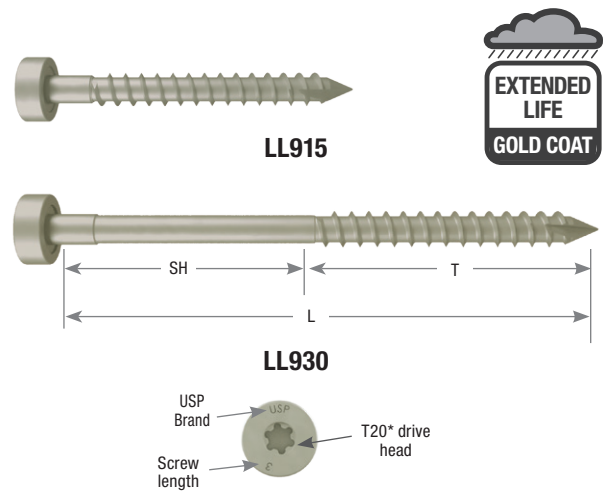
**Codes:** See page 12 for Code Reference Chart

**Installation:**

- Screws are self-drilling.
- Install using a low speed clutch drill with T20\* drive (not included). The washer head should be flat to the surface. Do not over-tighten the screws.
- Installing the screw at an angle may introduce additional bending and tension forces into the fastener if the screw head is not flat to the bearing surface. Care should be given to ensure the fastener is installed perpendicular to the plane of the fastener hole.
- **Impact drills are not recommended for use with LumberLok Screws**
- Reference list of MiTek connectors compatible with LumberLok screws on page 40.



Fasteners



**Specification Table**

Size	MiTek USP Stock No.	Ref. No.	Dimensions (in.)			Finish <sup>1</sup>	DF/SP Allowable (Lbs.) <sup>2,5</sup>				S-P-F Allowable (Lbs.) <sup>2,5</sup>				Code Ref.
			L	SH	T		Shear Capacity			Shear Capacity					
							Wood-to-Wood <sup>4</sup>	Steel-to-Wood 18 Ga	16 Ga	Withdrawal Capacity <sup>3</sup>	Wood-to-Wood <sup>4</sup>	Steel-to-Wood 18 Ga	16 Ga	Withdrawal Capacity <sup>3</sup>	
#9 x 1-3/8"	LL915	SD9112	1-3/8"	1/4"	1-1/8"	GC	--	105	130	120	--	105	105	110	IBC, FL, LA
#9 x 2-7/8"	LL930	SD9212	2-7/8"	1-3/8"	1-1/2"	GC	105	165	165	150	100	140	140	150	

- 1) GC = Gold Coat over Clear Zinc Trivalent.
- 2) Allowable shear loads assume a side plate tensile strength of 45 ksi.
- 3) Withdrawal loads are for steel-to-wood connections and assume a side plate thickness of 1/4" or less.
- 4) Shear loads for wood-to-wood connections assume a side member thickness of 1-1/2".
- 5) Loads are for 100% duration of load factors and may be increased for other duration factors in accordance with the NDS.

**Packaging Table**

Use	Size (in)	Retail Box Offering	
		MiTek USP Stock No.	Box/Ctn Qty
Exterior for Deck & other wood-to-wood connections	#9 x 1-3/8"	LL915R50	50-pack/24-ea
	#9 x 2-7/8"	LL930R50	50-pack/24-ea

Copyright © 2019 MiTek Industries, Inc. All Rights Reserved

\* T20 is a trademark of Acument

### Common deck connectors that are compatible with LumberLok Screws

This is not a complete list of MiTek connectors that are compatible with LumberLok Screws. Most connectors that are installed with nails can also be installed with LumberLok Screws. For the connectors shown below, the catalog allowable design values will not change when installed with the LumberLok Screws shown.

MiTek USP Stock No.	LumberLok Screws	
	LL915 Qty	LL930 Qty
JUS24-GC	--	6
JUS24-TZ	--	6
JUS24-2TZ	--	6
JUS26-GC	--	8
JUS26-TZ	--	8
JUS26-2GC	--	8
JUS26-2TZ	--	8
JUS28-GC	--	10
JUS28-TZ	--	10
JUS28-2TZ	--	10
JUS28-3TZ	--	10
JUS210-GC	--	12
JUS210-TZ	--	12
JUS210-2GC	--	14
JUS210-2TZ	--	14
JUS210-3TZ	--	14
JUS44-TZ	--	6
JUS46-TZ	--	8
JUS48-TZ	--	10
JUS410-TZ	--	14
SKH26L-GC	6	6
SKH26R-GC	6	6
SKH26L-TZ	6	6
SKH26R-TZ	6	6
SKH28L-TZ	8	10
SKH28R-TZ	8	10
SKH210L-GC	10	14
SKH210R-GC	10	14
SKH210L-TZ	10	14
SKH210R-TZ	10	14
SKH210L-2TZ	--	24
SKH210R-2TZ	--	24
AC5-TZ	--	6
AC7-GC	--	8
AC7-TZ	--	8
AC9-TZ	--	10
MPA1-GC	12	--
MPA1-TZ	12	--
MP34-TZ	8	--
MP4F-TZ	12	--

MiTek USP Stock No.	LumberLok Screws	
	LL915 Qty	LL930 Qty
MP3-TZ	--	6
MP5-TZ	--	8
MP7-GC	--	10
MP7-TZ	--	10
MP9-GC	--	12
MP9-TZ	--	12
RT3A-TZ	8	--
RT4-TZ	8	--
RT5-TZ	8	--
RT7-TZ	10	--
RT7A-GC	10	--
RT7A-TZ	10	--
RT8A-TZ	10	--
RT15-GC	10	--
RT15-TZ	10	--
RT16A-TZ	9	8
RT16-2TZ	16	--
ADTT-TZ	10	--
PB44-6GC	--	16
PB44-6TZ	--	16
PB66-6GC	--	16
PB66-6TZ	--	16
PBES44-TZ	--	16
PBES66-TZ	--	16
PA44E-GC	--	6
PA44E-TZ	--	6
PA44-TZ	--	8
PAU44-TZ	--	12
PA46E-GC	--	8
PA46E-TZ	--	8
PA46-TZ	--	14
PAU46-TZ	--	12
PA66E-GC	--	8
PA66E-TZ	--	8
PA66-TZ	--	16
PAU66-TZ	--	12
PAU88-TZ	--	14
SDPT5-TZ	5	--
SDPT7-TZ	5	--
CSH-TZ	10	--





## Product Offering Overview

EPOXY  
QUANTITY  
ESTIMATOR

Estimate how much epoxy your job needs. Quickly calculate the number of required cartridges using the Epoxy Quantity Estimator. Run our web application on your desktop, smart phone or tablet. The Estimator works with threaded rods or rebar. Enter the quantity, rod diameter and drilled hole depth, choose the epoxy type and the required number of cartridges is displayed. [MiTek-US.com/products/anchoring-solutions/anchoring-epoxy/](http://MiTek-US.com/products/anchoring-solutions/anchoring-epoxy/)

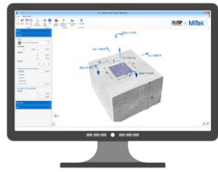
## CIA-GEL 7000-C Epoxy

## IAPMO ER-0473 Complies with 2015 IBC &amp; 2015 IRC

CIA-GEL 7000-C Epoxy is an adhesive designed to attach anchor rods into concrete that is, or may become, cracked due to cyclic loading from wind or earthquakes. It may also be used with fully grouted CMU construction. It is a low odor, solvent free, non-shrink, non-sag adhesive. The two-component (resin and hardener) epoxy is supplied in equal volume cartridges, which are combined in a 1:1 ratio when dispensed through the attached mixing nozzle. Either a hand powered or air-powered dispenser may be used. The cartridges are sealed with a D-plug which opens easily and allows partially used cartridges to be saved for later use. The epoxy has a two year shelf life when stored in unopened containers at temperatures between 50°F and 77°F.

## Applications:

- Anchors threaded rod or deformed rebar into cracked or uncracked concrete.
- Anchoring All Thread Rod for holdowns into concrete for high seismic zones (SDC C-F)
- Horizontal and overhead anchoring applications (requires special inspection)



**MiTek Adhesive Anchor Design** is powerful design software for CIA-GEL 7000-C that provides optimized epoxy connection solutions for threaded anchors post-installed into concrete. The software determines the required anchor rod steel grade, diameter and effective embedment depth based on applied factored tension, shear and moment loads. Get the free download at [MiTek-US.com/software/Adhesive-Anchor-Design](http://MiTek-US.com/software/Adhesive-Anchor-Design).

**Codes:** ER-0473, FL17248, L.A. City RR 25991, NSF/ANSI Standard 61



**Available Sizes:**  
8.5 oz. – GEL7C-10  
20.3 oz. – GEL7C-22  
50.7 oz. – GEL7C-56

## CIA-GEL 7000 Epoxy

## ICC-ES ESR-1702 Complies with 2018 IBC &amp; 2018 IRC

CIA-GEL 7000 Epoxy is a structural adhesive specifically designed to attach anchor rods into fully grouted concrete masonry units (CMU) and is evaluated to ICC-ES AC508 for seismic, sustained load, elevated temperature and freeze-thaw suitability conditions. It can also be used to install anchor bolts into uncracked concrete and reinforced brick. It is a low odor, solvent free, non-shrink adhesive. The two-component (resin and hardener) epoxy is supplied in equal volume cartridges, which are combined in a 1:1 ratio when dispensed through the attached mixing nozzle. Either a hand powered or air-powered dispenser may be used. The cartridges are sealed with a D-plug which opens easily and allows partially used cartridges to be saved for later use. The epoxy has a two year shelf life when stored in unopened containers at a temperature of 70°F.

## Applications:

- Anchors All-Thread rod and deformed rebar into fully grouted CMU
- Brick veneer anchoring
- Crack injection of medium to wide cracks
- Anchors rebar and threaded steel rod into uncracked concrete.

**Codes:** ESR-1702, FL17247, NSF/ANSI Standard 61



**Available Sizes:**  
8.6 oz. – GEL7-10  
21.2 oz. – GEL7-22

# Anchoring Epoxy

## CIA-GEL 6000-GP Epoxy

### Tested to AC-58 standards – Compliant to ASTM C881-10

CIA-GEL 6000-GP is a superior epoxy specifically designed for general purpose structural applications that require quick load times and for doweling applications requiring state DOT approval. It is a two-component (1:1 ratio) adhesive epoxy with 100% solids and is solvent free, moisture insensitive, non-sag and odorless. It provides exceptional strength in anchoring and doweling applications and can be used in temperatures between 35°F and 110°F. The epoxy has a two year shelf life when stored in unopened containers at temperatures between 40°F and 95°F.

#### Applications:

- Doweling applications for rebar and tie bars for full depth concrete pavement repairs
- Anchoring and bracing for short term tensile load where dynamic, vibratory, wind or intermittent loads exist
- Use in concrete, grout filled block and unreinforced masonry for general purpose anchoring and doweling applications
- Concrete doweling road repairs where DOT approval is required.

**Codes:** Multiple State DOT listings



**Available Sizes:**  
21.2 oz. – GEL6GP-22

## CIA-EA Epoxy Acrylate

### IAPMO ER-0311, ICC-ES AC308, Complies with 2015 IBC and 2015 IRC

CIA-EA Adhesive Anchoring System is an epoxy acrylate specifically designed to be a high strength, fast cure structural adhesive for anchoring threaded rod and deformed rebar into uncracked concrete. It has the added advantage of being formulated to be used in colder temperatures (32°F) while maintaining excellent flowability. CIA-EA may also be used with fully grouted CMU and reinforced brick construction. It is a 2-component, 100% solids, moisture insensitive adhesive that is ideally suited for a wide range of applications. It is composed of a proprietary blend of solvent free epoxy acrylate resin and is backed by independent research and testing. The epoxy has a 15 month shelf life when stored in unopened containers at temperatures between 41°F to 77°F.

#### Applications:

- Anchors All-Thread rod into concrete
- May also be used to anchor rebar, starter bars and dowels
- Applications requiring fast cure times
- Cold weather applications
- Can be used in horizontal anchoring applications
- Can be used in overhead anchoring applications (requires special inspection)

**Codes:** ER-0311, NSF/ANSI Standard 61



**Available Sizes:**  
9.4 oz. – EA-10

## Incredi-Bond® Epoxy

Incredi-Bond® is a high strength two-component epoxy specifically designed to be a bonding agent for almost all household materials including wood, steel, concrete, brick, stone and CMU block. It is moisture insensitive and can also be used to fill cracks in concrete, block and stone. The epoxy has a 2 year shelf life when stored in unopened containers in dry conditions between 40°F to 90°F.

#### Applications:

- Bonding applications for: Concrete • Brick • CMU block • Stone • Metal • Wood
- Repair vertical and overhead cracks in concrete (non-structural)
- Repair vertical and overhead spalls in concrete (5/8" deep & 3" diameter max)
- Non-sag consistency makes this ideal for corner repairs to concrete and block walls
- Repair and replace brick
- Replace pool tile (no need to empty pool)
- Fill holes and cracks
- Not recommended for structural applications



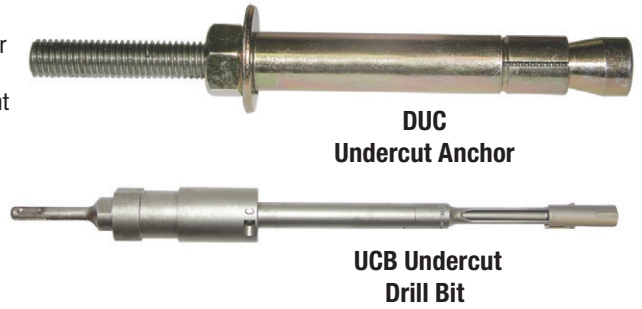
**Available Sizes:**  
8.6 oz. – IB-9

DUCs are mechanical anchors expanded into holes that have been undercut at the bottom using an undercutting drill bit. This creates a true bearing type anchor that performs like a cast-in-place headed anchor. Load is transferred into the concrete through bearing, not friction like traditional expansion anchors. Excellent performance in seismic and dynamic loading conditions. Meets ACI 318-14 Chapter 17 (2018 IBC) requirements as a code anchor, including seismic loading, tension zone, and cracked concrete provisions.

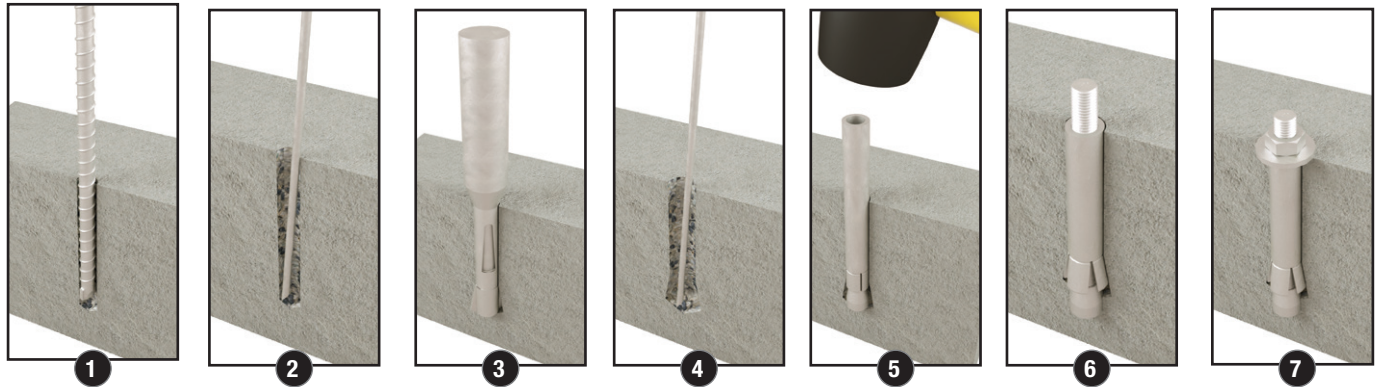
**Rod Materials:** ASTM A36 (L Series), A193 Grade B7 (H Series), or AISI 316 Stainless Studs

**Anchor Body Materials:** ASTM A 513 Type 5, or AISI 316 Stainless

**Codes:** See page 12 for Code Reference Chart



**Installation:**



1 Drill the hole to proper depth and diameter per specifications using rotohammer and stop drill.

2 Clean the hole using a blow-out bulb or compressed air.

3 Insert the undercut bit and start rotohammer. Undercutting is complete when the stopper sleeve is fully compressed (gap closed).

4 Clean the hole again using a blow-out bulb or compressed air.

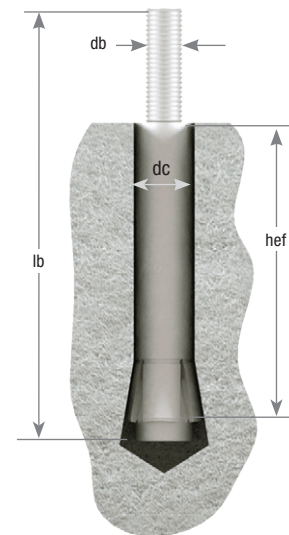
5 Insert anchor into hole. Place setting sleeve over anchor and drive the expansion sleeve over the expansion coupling.

6 Verify that the setting mark is visible on the threaded rod above the sleeve.

7 Apply proper torque.

**Tension and shear capacities for DUC Anchors in  $f'_c \geq 2,500$  psi concrete**

MiTek USP Stock No.	Rod Dia. $d_b$ (in)	Anchor Length $l_b$ (in)	Expansion Coupling Dia. $d_c$ (in)	Drilled Hole Depth of Stop Bit (in)	Effective Embedment $h_{ef}$ (in)	Allowable Tensile Capacity (Lbs.)	Allowable Shear Capacity (Lbs.)	Code Ref.	
DUC38-275L	3/8	5-1/2	5/8	3-1/8	2-3/4	2280	2245	IBC, FL, LA	
DUC38-275LT		6-3/4		4-3/8	4	4910	4855		
DUC38-400H			7	4-1/4	4	4170	4110		
DUC38-400HT		1/2		8	3/4	5-1/4	5		7365
DUC12-400L	9-3/4		7	7		6-3/4	8990		
DUC12-400LT			5/8	7-3/4	1	5	4-1/2		6290
DUC12-500H	10-3/4			8		7-1/2	13530		14110
DUC12-500HT		12-1/4		9-1/2		9	14315		
DUC12-675H	3/4			8-5/8		1-1/8	5-7/8		5
DUC12-675HT		13-5/8	10-7/8	10	20830		20875		
DUC58-450L			5/8	10-3/4	1	8	7-1/2		13530
DUC58-450LT		12-1/4		9-1/2		9	14315		
DUC58-750H	5/8		10-3/4	1	8	7-1/2	13530		14110
DUC58-750HT		12-1/4	9-1/2		9	14315			
DUC58-900H	5/8		12-1/4	1	9-1/2	9	14315		14110
DUC58-900HT		3/4	8-5/8		1-1/8	5-7/8	5		
DUC34-500L	3/4		13-5/8	1-1/8		10-7/8	10	20830	20875
DUC34-500LT		13-5/8	10-7/8		10	20830	20875		
DUC34-1000H	3/4		13-5/8	1-1/8	10-7/8	10	20830	20875	
DUC34-1000HT		13-5/8	10-7/8		10	20830	20875		



Copyright © 2019 MiTek Industries, Inc. All Rights Reserved

1) Allowable tensile and shear capacities are for anchors installed at standard edge distance and spacing in uncracked concrete in accordance with the 2018, 2015, and 2012 IBC and referenced ACI documents.

2) See ICC-ES ESR-1970 for replacement parts.

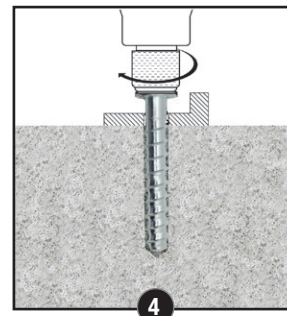
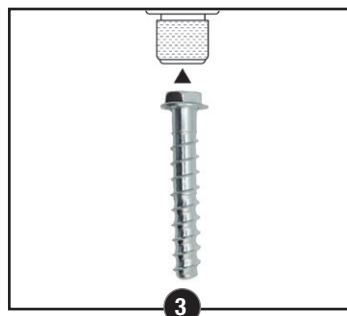
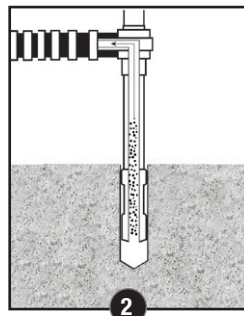
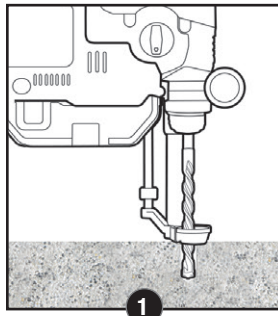
New products or updated product information are designated in blue font.

Screw-Bolt+ anchors are a one-piece, heavy duty screw anchor with a finished hex head. The patented thread design, designed for use with standard ANSI drill bits, reduces installation torque and enhances productivity. The steel threads along the anchor body tap into the hole during installation to provide keyed engagement and allow for reduced edge and spacing distances.

**Finish:** Zinc Plated or Mechanically Galvanized

**Codes:** See page 12 for Code Reference Chart

**Installation:**



Using the proper drill bit size, drill a hole into the base material to the required depth. The tolerances of the drill bit used should meet the requirements of ANSI standard B212.15

Remove dust and debris from hole during drilling (e.g. dust extractor, hollow bit) or following drilling (e.g. suction, forced air) to extract loose particles created during drilling.

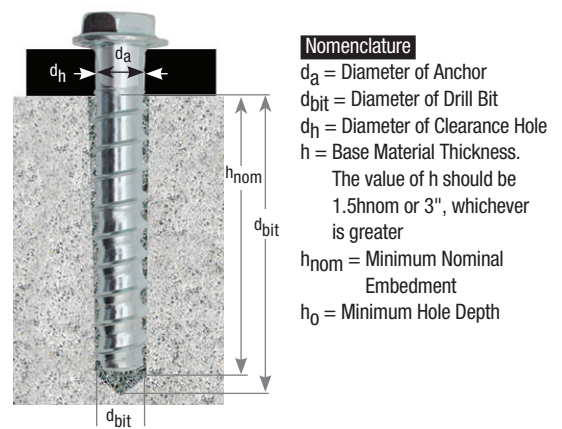
Select a torque wrench or powered impact wrench and do not exceed the maximum torque, Tinst, max or Timpact,max respectively for the selected anchor diameter and embedment. Attach an appropriate sized hex socket/driver to the impact wrench. Mount the screw anchor head into the socket.

Drive the anchor into the hole until the head of the anchor comes into contact with the fixture. The anchor must be snug after installation. Do not spin the hex socket off the anchor to disengage.



**Screw-Bolt™ +**  
(zinc plated)

Zinc Plated		Mechanically Galvanized		Anchor Size (in) <sup>1</sup>	Hole Size (in)	Socket Size (in)	Code Ref.
MiTek USP Stock No.	Ref. No.	MiTek USP Stock No.	Ref. No.				
PFM1411000	THDB25178H	--	--	1/4 x 1-1/4	1/4	7/16	IBC
PFM1411020	THD25134H	--	--	1/4 x 1-3/4			
PFM1411060	THD25214H	--	--	1/4 x 2-1/4			
PFM1411100	THDB25300H	--	--	1/4 x 3			
PFM1411160	THD37134H	--	--	3/8 x 1-3/4	3/8	9/16	
PFM1411220	THD37212H	--	--	3/8 x 2-1/2			
PFM1411240	THD37300H	--	--	3/8 x 3			
PFM1411280	THD37400H	PFM1461280	THD37400HMG	3/8 x 4			
PFM1411300	THD37500H	PFM1461300	THD37500HMG	3/8 x 5	1/2	3/4	
PFM1411320	THD37600H	PFM1461320	THD37600HMG	3/8 x 6			
PFM1411340	--	--	--	1/2 x 2			
PFM1411360	--	--	--	1/2 x 2-1/2			
PFM1411380	THD50300H	--	--	1/2 x 3	5/8	15/16	
PFM1411420	THD50400H	PFM1461420	THD50400HMG	1/2 x 4			
PFM1411460	THD50500H	PFM1461460	THD50500HMG	1/2 x 5			
PFM1411480	THD50600H	PFM1461480	THD50600HMG	1/2 x 6			
PFM1411520	THD50800H	PFM1461520	THD50800HMG	1/2 x 8	3/4	1-1/8	
PFM1411540	--	--	--	5/8 x 3			
PFM1411580	THD62400H	--	--	5/8 x 4			
PFM1411600	THD62500H	PFM1461600	THD62500HMG	5/8 x 5			
PFM1411640	THD62600H	PFM1461640	THD62600HMG	5/8 x 6	3/4	1-1/8	
PFM1411680	THD62800H	PFM1461680	THD62800HMG	5/8 x 8			
PFM1411700	--	--	--	3/4 x 3			
PFM1411720	THD75400H	--	--	3/4 x 4			
PFM1411760	THD75500H	--	--	3/4 x 5	3/4	1-1/8	
PFM1411800	THD75600H	PFM1461800	THD75600HMG	3/4 x 6			
PFM1411840	THD75812H	--	--	3/4 x 8			
--	--	PFM1461850	THD75812HMG	3/4 x 8-1/2			
PFM1411880	THD75100H	--	--	3/4 x 10			



**Screw-Bolt™ + anchor detail**

**Nomenclature**  
 $d_a$  = Diameter of Anchor  
 $d_{bit}$  = Diameter of Drill Bit  
 $d_h$  = Diameter of Clearance Hole  
 $h$  = Base Material Thickness.  
 The value of  $h$  should be 1.5 $h_{nom}$  or 3", whichever is greater  
 $h_{nom}$  = Minimum Nominal Embedment  
 $h_0$  = Minimum Hole Depth

1) The anchor size includes the diameter and length of the anchor measured from under the head.

## Power-Stud® HD5 Wedge Expansion Anchors

The Power-Stud® HD5 anchor is a fully threaded, torque-controlled, wedge expansion anchor. Suitable base materials include normal-weight concrete and structural sand-lightweight concrete. Nut and washer are included.

**Materials:** Anchor Body & Expansion Clip: Carbon Steel;  
Expansion Clip: Stainless Steel; Hex Nut: ASTM A 653;  
Washer: ASTM F 844

**Finish:** Hot-dip galvanized

**Codes:** See page 12 for Code Reference Chart



Power-Stud® HD5

MiTek USP Stock No. <sup>2</sup>	Ref. No.	Anchor Size (in) <sup>1</sup>	Thread Length (in)	Code Ref.
7716HD5	WA37500MG	3/8 x 5	3-1/2	--
7720HD5	WA50234MG	1/2 x 2-3/4	1	
7723HD5	WA50414MG	1/2 x 4-1/2	2-3/4	
7724HD5	WA50512MG	1/2 x 5-1/2	3-3/4	
7726HD5	WA50700MG	1/2 x 7	5-1/4	
7733HD5	WA62500MG	5/8 x 5	3	
7734HD5	WA62600MG	5/8 x 6	4	
7738HD5	WA62812MG	5/8 x 8-1/2	6-1/2	
7748HD5	WA75812MG	3/4 x 8-1/2	6	

1) The anchor size includes the diameter and the overall length of the anchor.

2) All anchors are packaged with nuts and washers.

## Power-Stud+® SD1 Wedge Expansion Anchors

Power-Stud+® SD1 anchor is a fully threaded, torque-controlled, wedge expansion anchor which is designed for consistent performance in cracked and uncracked concrete. Suitable base materials include normal-weight concrete, structural sand-lightweight concrete and concrete over metal deck. Nut and washer are included.

**Materials:** Anchor Body & Expansion Clip: Carbon Steel;  
Hex Nut: ASTM A 563, Grade A; Washer: ASTM F 844

**Finish:** Zinc Plating

**Codes:** See page 12 for Code Reference Chart



Power-Stud+®  
SD1 anchor

MiTek USP Stock No. <sup>2</sup>	Ref. No.	Anchor Size (in) <sup>1</sup>	Thread Length (in)	Code Ref.
7413SD1	WA37300	3/8 x 3	1-5/8	IBC
7416SD1	WA37500	3/8 x 5	3-5/8	
7424SD1	WA50512	1/2 x 5-1/2	3-3/4	
7426SD1	WA50700	1/2 x 7	5-1/4	
7427SD1	WA50812	1/2 x 8-1/2	6-3/4	
7433SD1	WA62500	5/8 x 5	3	
7434SD1	WA62600	5/8 x 6	4	
7436SD1	WA62700	5/8 x 7	5	
7438SD1	WA62812	5/8 x 8-1/2	6-1/2	
7439SD1	WA62100	5/8 x 10	8	
7442SD1	WA75512	3/4 x 5-1/2	3	

1) The anchor size includes the diameter and the overall length of the anchor.

2) All anchors are packaged with nuts and washers.

# THR Threaded Rods



THR's support the deck oriented code requirements for mechanically reinforced railing post and deck to house ledger board attachments. THR is manufactured from ASTM F1554 Grade 36 with a minimum tensile strength of 58 ksi.

**Materials:** ASTM A36 steel, also conforms to ASTM F1554, Grade 36

**Finish:** Hot-dip galvanized

**Codes:** See page 12 for Code Reference Chart

**Installation:**

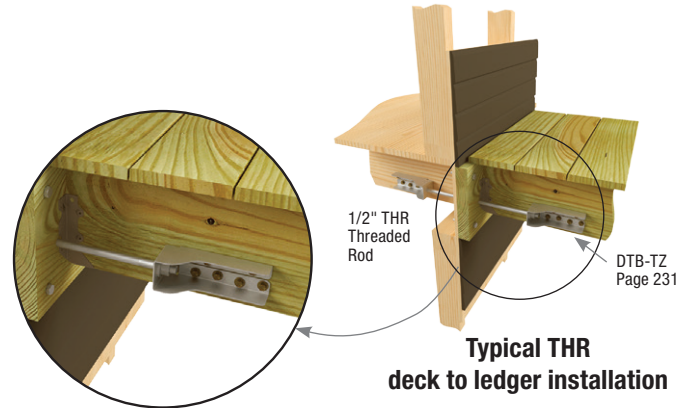
- Install into wet concrete with nut embedded or drill minimum 1/16" – 1/8" oversized hole depending on rod size and secure with anchor epoxy. Nut and washer is included.



Typical THR installation



THR



Typical THR deck to ledger installation

MiTek USP Stock No.	Ref. No.	Bolt Dia.	L (in)	Corrosion Finish	Code Ref.
THR125-HDG	RFB#4X5HDG	1/2	5		
THR126-HDG	RFB#4X6HDG	1/2	6		
THR128-HDG	RFB#4X8HDG	1/2	8		
THR1218-HDG	--	1/2	18		
THR1224-HDG	--	1/2	24		--
THR1236-HDG	--	1/2	36		
THR588-HDG	RFB#5X8HDG	5/8	8		
THR5812-HDG	RFB#5X12HDG	5/8	12		
THR5816-HDG	RFB#5X16HDG	5/8	16		

**Corrosion Finish**

- Stainless Steel
- Gold Coat
- HDG
- Triple Zinc

## ARC Anchor Rod Chairs

When attached to the forms, the ARC allows for easy and precise placement of anchor rods prior to pouring concrete. The "chair" and nut are pre-assembled for quick installation.

**Features:**

- Positive stop for threaded rod at the bottom of the nut
- Easy flow of concrete
- Nibbled out corners allows for potentially tighter positioning on inside corner of form
- 1" stand-off base to meet code requirement for concrete cover

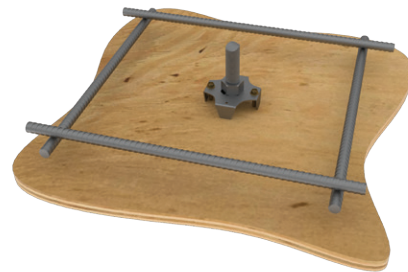
**Materials:** Nut: Heavy hex; Chair: 16 gauge

**Finish:** Nut: None; Chair: Rolled Steel

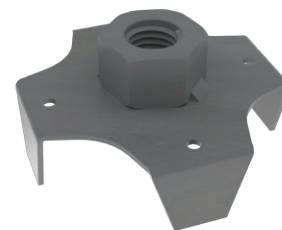
**Installation:**

- Installs with nails or screws. Threaded rod can then be screwed in to desired depth.

MiTek USP Stock No.	Ref. No.	Dia. (in)	Code Ref.
ARC4	ABL4-1	1/2	
ARC5	ABL5-1	5/8	
ARC6	ABL6-1	3/4	
ARC7	ABL7-1	7/8	
ARC8	ABL8-1	1	
ARC9	ABL9-1	1-1/8	--
ARC10	ABL10-1	1-1/4	
ARC11	--	1-3/8	
ARC12	--	1-1/2	
ARC14	--	1-3/4	
ARC16	--	2	



Typical ARC installation



ARC6

Embossed ends provide guides for embedment angle and depth. An embedment line is embossed on the shaft for easy installation. Features rolled threads for high tensile strength.

**STB** – For monolithic slabs and concrete stem walls.

**STBL** – Designed for use with 3x sill plates.  
Excellent choice for use with taller holddown washers like those in the PHD series.

**Materials:** ASTM A 36 steel, also conforms to ASTM F1554 and ASTM A 307 Grade A requirements for bolts.

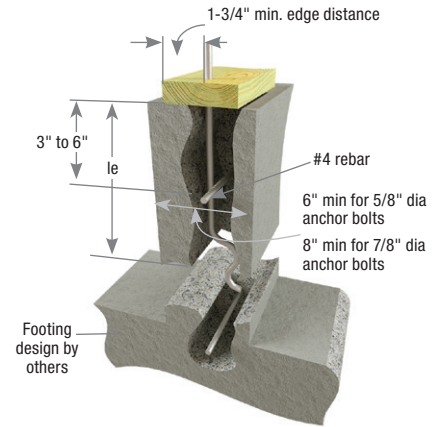
**Finish:** None

**Options:** See Chart for Corrosion Finish Options

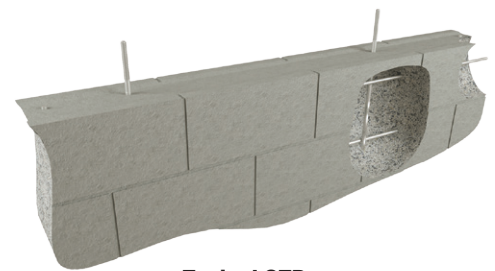
**Codes:** See page 12 for Code Reference Chart

**Installation:**

- Select appropriate STB or STBL Anchor Bolt.
- Use normal weight concrete with minimum compressive strength of 2,500 psi.
- Minimum center-to-center spacing between bolts is 3(E) for anchors acting simultaneously in tension.
- Match embedment depth with embedment line on the STB or STBL shaft.
- The STB or STBL does not need to be tied to the rebar.
- Nuts and washers are not included.



**Typical STB anchor bolt installation**



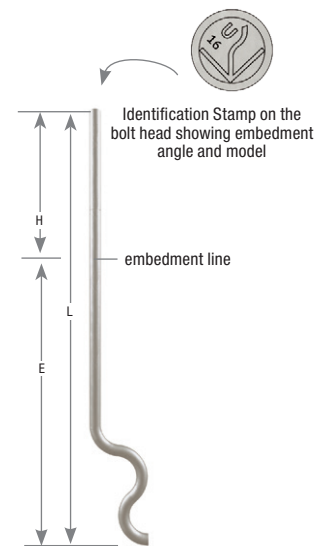
**Typical STB concrete block installation**

**Anchor Bolt Selection Table**

MiTek USP Stock No.	2x, 3x, (2) 2x Sill Plates <sup>1</sup>
	Mono Pour
PHD2A	STB16 STBL16
TDX2-TZ	
LTS20B	
HTT16	
HTT45	
PHD4A	STB20 STBL20
HTT45	
TD5	
HTT45	STB24 STBL24
HTT45	
PHD5A	STB28 STBL28
PHD8	
UPHD8	
TD7	
TD9	
TD12	

\* Recommend installation of washer under nut of anchor bolt.

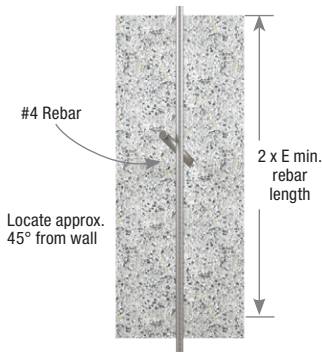
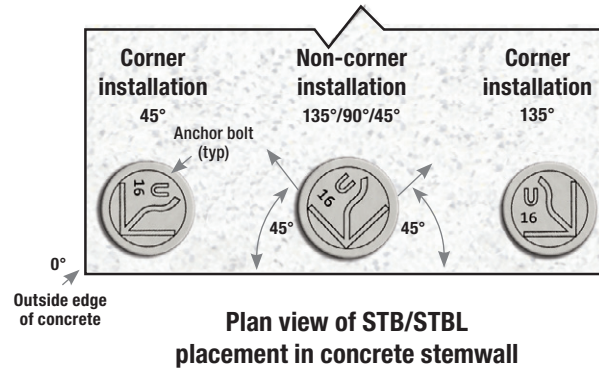
1) STBL model are recommended for use with PHD and UPHD8 holdowns on (2) 2x and 3x sill plates.



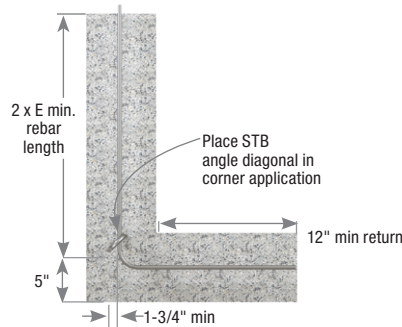
**STB/STBL**

**Monolithic or Stem Wall Foundations** – Prior to pour, install the STB or STBL in an upright position and at a 45° angle to the wall. Install one horizontal #4 rebar at a depth of 4" (minimum). (See illustrations.)

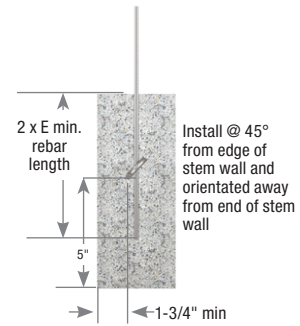
**Concrete Block Applications** – Prior to cell pour, install the STB or STBL in an upright position and at a 45° angle to the wall. (See illustrations.) Use the embossed angle guide on the end of the STB or STBL shaft as a guide. Install one horizontal #4 rebar at a depth of 4" and one vertical #4 rebar maximum 48" o.c. spacing. Fill all cells with concrete having a minimum 2,500 psi compressive strength.



**Plan view along continuous stem wall installation**



**Plan view of corner of stem wall installation**



**Plan view of end of stem wall installation**

MiTek USP Stock No.	Ref. No.	Dimensions (in)					Allowable Tension Loads (Lbs) <sup>1,2</sup>									Corrosion Finish	Code Ref.
		Stem-wall Width	Dia.	L	H	Min. Embed (E)	SDC A&B			Wind			SDC C - F				
							Midwall	Corner	End Wall	Midwall	Corner	End Wall	Midwall	Corner	End Wall		
STB16	SSTB16	6	5/8	17-13/16	5	12-13/16	4230	4230	4230	4230	4230	4230	3525	3525	3525	IBC, FL, LA	
STB20	SSTB20	6	5/8	21-13/16	5	16-13/16	5120	4740	4740	5115	4230	4230	4265	3555	3555		
STB24	SSTB24	6	5/8	25-13/16	5	20-13/16	5990	5915	5915	5990	5570	5570	4990	4675	4675		
STB28	SSTB28	8	7/8	31	5	26	10100	9490	9490	9110	9110	9110	7650	7650	7650		
STB34	SSTB34	8	7/8	36	6	30	11415	10525	10250	11390	10525	9405	9515	8770	7900		
STB36	SSTB36	8	7/8	38	8	30	11415	10525	10250	11390	10525	9405	9515	8770	7900		
STBL16	SSTB16L	6	5/8	19-9/16	6-3/4	12-13/16	4230	4230	4230	4230	4230	4230	3525	3525	3525		
STBL20	SSTB20L	6	5/8	23-9/16	6-3/4	16-13/16	5120	4740	4740	5115	4230	4230	4265	3555	3555		
STBL24	SSTB24L	6	5/8	27-9/16	6-3/4	20-13/16	5990	5915	5915	5990	5570	5570	4990	4675	4675		
STBL28	SSTB28L	8	7/8	32-3/4	6-3/4	26	10100	9490	9490	9110	9110	9110	7650	7650	7650		

- 1) Loads may not be increased for short term loading.
- 2) Minimum center to center spacing between bolts is 3(E) for anchors acting in tension simultaneously.
- 3) Minimum edge distance is 1-3/4".
- 4) Concrete stemwall shall be a minimum of 6" thick for 5/8" anchor bolts and 8" for 7/8" anchor bolts.
- 5) End distance shall be no less than 5".
- 6) Connection is limited by lowest of bolt or holdown capacity.
- 7) Concrete block shall be minimum 10" block.
- 8) See ICC-ES ESR-2266 for additional information.

**Corrosion Finish**

- Stainless Steel
- Gold Coat
- HDG
- Triple Zinc



The AB anchor bolt provides an economical way to meet the prescriptive requirements of the 2015 IRC for securing mudsill plates to a concrete or masonry foundation. The bolt is manufactured from ASTM 1554 steel and has a hot-dip galvanized finish. A nut (ASTM A 563) and washer (ASTM F 844) are included. In some jurisdictions, a plate washer may be required. Check with your local Building Official.

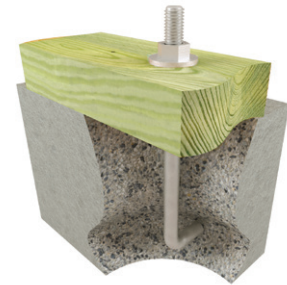
**Materials:** Bolt: ASTM F 1554, Nut: ASTM A 563, Washers: ASTM F 844

**Finish:** Hot-dip galvanized

**Codes:** See page 12 for Code Reference Chart. See IRC R403.1.6, IBC 2308.6, 2308.12.8, 2308.12.9 for minimum diameter and embedment into masonry or concrete.

**Installation:**

- Select appropriate AB Anchor Bolt.
- Use concrete with minimum compressive strength of 2,500 psi at 28 days.
- Nuts and washers are included.
- Anchor bolts intended for use to satisfy code prescribed anchoring of mudsill plates, and shall be installed as defined in the code.
- Allowable loads shall be derived in accordance with the code.
- Plate washers may be required in some jurisdictions.



Typical AB128-HDG installation



AB128-HDG

MiTek USP Stock No.	Ref. No.	Bolt Dia.	L (in)	Corrosion Finish	Code Ref.
AB126-HDG	--	1/2	6		PR
AB128-HDG	--	1/2	8		
AB1212-HDG	--	1/2	12		
AB5812-HDG	--	5/8	12		

**Corrosion Finish**  
■ Stainless Steel  
■ Gold Coat  
■ HDG  
■ Triple Zinc

## BP / HBPS / LBP / LBPS Bearing Plates

**BP / LBP** – Designed to meet code requirements for mudsill-to-foundation.

**HBPS / LBPS** – Offers anchor bolt adjustment slots.

**Materials:** See chart

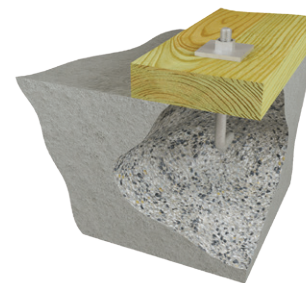
**Finish:** BP / HBPS – none; LBP / LBPS – G-185 galvanizing

**Options:** See Chart for Corrosion Finish Options

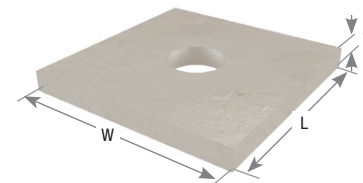
**Codes:** See page 12 for Code Reference Chart. See IRC R602.11.1, IBC 2308.12.8 for minimum plate size requirements.

**Installation:**

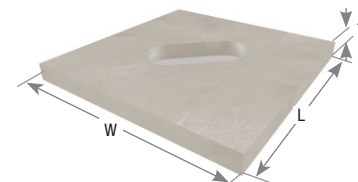
- Bolt holes are sized 1/16" larger than Bolt Dia. shown in chart.



Typical Bearing Plate installation



BP / LBP Standard Bearing Plate



HBPS / LBPS Slotted Bearing Plate

MiTek USP Stock No.	Ref. No.	Plate		Dimensions (in)		Bolt Dia.	Corrosion Finish	Code Ref.
				Thickness (T)	W			
LBP12-TZ	LBP1/2, LBP1/2Z	10 Ga	9/64	2	2	1/2		--
LBP58-TZ	LBP5/8, LBP5/8Z	10 Ga	9/64	2	2	5/8		PR
LBPS12-TZ	LBPS1/2, LBPS1/2Z	10 Ga	9/64	3	3	1/2		--
LBPS58-TZ	LBPS5/8, LBPS5/8Z	10 Ga	9/64	3	3	5/8		
HBPS12	BPS1/2-3	3 Ga	1/4	3	3	1/2		PR
HBPS34	BPS3/4-3	3 Ga	1/4	3	3	3/4		
HBPS58	BPS5/8-3	3 Ga	1/4	3	3	5/8		
BP12	BP1/2	7 Ga	3/16	2	2	1/2		
BP582	BP5/8-2	7 Ga	3/16	2	2	5/8		
BP583	BP5/8, BP5/8-3	3 Ga	1/4	3	3	5/8		
BP343	BP3/4-3	3 Ga	1/4	3	3	3/4		

**Corrosion Finish**  
■ Stainless Steel  
■ Gold Coat  
■ HDG  
■ Triple Zinc

ATR All Thread Rod is a continuously threaded low carbon steel rod that may be used for anchoring MiTek's holdowns, tension ties and wood structural panel shear walls to concrete. They can also be used for many other general purpose tension transfer fastening needs.

**Materials:** ASTM A307 Grade A

**Finish:** None or Zinc Plated (See Chart)

**Codes:** See page 12 for Code Reference Chart

**Installation:**

- ATR All Thread Rod can be cast-in-place or epoxied into concrete. Use MiTek's CIA-EA epoxy acrylate or CIA-GEL 7000-C epoxy when installed as a post installed application and follow the published installation instructions to obtain maximum strength. Use CIA-GEL 7000 when installing into fully grouted CMU block wall. Reference MiTek's Adhesive Design Software for more information, MiTek-US.com.



Dia. x L (in)	Plain		Zinc Plated		Code Ref.
	MiTek USP Stock No.	Ref. No.	MiTek USP Stock No.	Ref. No.	
3/8 x 5	ATR385	--	ATR385-ZP	--	
3/8 x 8	ATR388	--	ATR388-ZP	--	
3/8 x 10	ATR3810	--	ATR3810-ZP	--	
3/8 x 12	ATR3812	ATR3/8X12	ATR3812-ZP	--	
3/8 x 16	ATR3816	--	ATR3816-ZP	--	
3/8 x 18	ATR3818	--	ATR3818-ZP	--	
3/8 x 24	ATR3824	ATR3/8X24	ATR3824-ZP	--	
3/8 x 36	ATR3836	ATR3/8X36	ATR3836-ZP	--	
3/8 x 48	ATR3848	ATR3/8X48	ATR3848-ZP	ATR3/8X48ZP	
3/8 x 72	ATR3872	ATR3/8X72	--	--	
1/2 x 5	ATR125	--	ATR125-ZP	--	
1/2 x 8	ATR128	--	ATR128-ZP	--	
1/2 x 10	ATR1210	--	ATR1210-ZP	--	
1/2 x 12	ATR1212	ATR1/2X12	ATR1212-ZP	--	
1/2 x 16	ATR1216	--	ATR1216-ZP	--	
1/2 x 18	ATR1218	ATR1/2X18	ATR1218-ZP	--	
1/2 x 24	ATR1224	ATR1/2X24	ATR1224-ZP	--	
1/2 x 36	ATR1236	ATR1/2X36	ATR1236-ZP	--	
1/2 x 48	ATR1248	ATR1/2X48	ATR1248-ZP	--	
1/2 x 72	ATR1272	ATR1/2X72	--	--	
5/8 x 5	ATR585	--	ATR585-ZP	--	--
5/8 x 8	ATR588	ATR5/8X8	ATR588-ZP	ATR5/8X8ZP	
5/8 x 10	ATR5810	--	ATR5810-ZP	--	
5/8 x 12	ATR5812	ATR5/8X12	ATR5812-ZP	ATR5/8X12ZP	
5/8 x 16	ATR5816	--	ATR5816-ZP	--	
5/8 x 18	ATR5818	ATR5/8X18	ATR5818-ZP	ATR5/8X18ZP	
5/8 x 24	ATR5824	ATR5/8X24	ATR5824-ZP	ATR5/8X24ZP	
5/8 x 36	ATR5836	ATR5/8X36	ATR5836-ZP	ATR5/8X36ZP	
5/8 x 48	ATR5848	ATR5/8X48	ATR5848-ZP	--	
5/8 x 72	ATR5872	ATR5/8X72	--	--	
3/4 x 5	ATR345	--	ATR345-ZP	--	
3/4 x 8	ATR348	ATR3/4X8	ATR348-ZP	ATR3/4X8ZP	
3/4 x 10	ATR3410	--	ATR3410-ZP	--	
3/4 x 12	ATR3412	ATR3/4X12	ATR3412-ZP	ATR3/4X12ZP	
3/4 x 16	ATR3416	--	ATR3416-ZP	--	
3/4 x 18	ATR3418	ATR3/4X18	ATR3418-ZP	ATR3/4X18ZP	
3/4 x 24	ATR3424	ATR3/4X24	ATR3424-ZP	ATR3/4X24ZP	
3/4 x 36	ATR3436	ATR3/4X36	ATR3436-ZP	ATR3/4X36ZP	
3/4 x 48	ATR3448	ATR3/4X48	ATR3448-ZP	ATR3/4X48ZP	
3/4 x 72	ATR3472	ATR3/4X72	--	--	

Dia. x L (in)	Plain		Zinc Plated		Code Ref.
	MiTek USP Stock No.	Ref. No.	MiTek USP Stock No.	Ref. No.	
3/4 x 5	ATR345	--	ATR345-ZP	--	
3/4 x 8	ATR348	ATR3/4X8	ATR348-ZP	ATR3/4X8ZP	
3/4 x 10	ATR3410	--	ATR3410-ZP	--	
3/4 x 12	ATR3412	ATR3/4X12	ATR3412-ZP	ATR3/4X12ZP	
3/4 x 16	ATR3416	--	ATR3416-ZP	--	
3/4 x 18	ATR3418	ATR3/4X18	ATR3418-ZP	ATR3/4X18ZP	
3/4 x 24	ATR3424	ATR3/4X24	ATR3424-ZP	ATR3/4X24ZP	
3/4 x 36	ATR3436	ATR3/4X36	ATR3436-ZP	ATR3/4X36ZP	
3/4 x 48	ATR3448	ATR3/4X48	ATR3448-ZP	ATR3/4X48ZP	
3/4 x 72	ATR3472	ATR3/4X72	--	--	
7/8 x 5	ATR785	--	ATR785-ZP	--	
7/8 x 8	ATR788	--	ATR788-ZP	--	
7/8 x 10	ATR7810	--	ATR7810-ZP	--	
7/8 x 12	ATR7812	ATR7/8X12	ATR7812-ZP	ATR7/8X12ZP	
7/8 x 16	ATR7816	--	ATR7816-ZP	--	
7/8 x 18	ATR7818	--	ATR7818-ZP	--	
7/8 x 24	ATR7824	ATR7/8X24	ATR7824-ZP	ATR7/8X24ZP	
7/8 x 36	ATR7836	ATR7/8X36	ATR7836-ZP	ATR7/8X36ZP	
7/8 x 48	ATR7848	ATR7/8X48	ATR7848-ZP	--	
7/8 x 72	ATR7872	ATR7/8X72	--	--	
1 x 5	ATR15	--	ATR15-ZP	--	--
1 x 8	ATR18	--	ATR18-ZP	--	
1 x 10	ATR110	--	ATR110-ZP	--	
1 x 12	ATR112	ATR1X12	ATR112-ZP	ATR1/2X12ZP	
1 x 16	ATR116	--	ATR116-ZP	--	
1 x 18	ATR118	--	ATR118-ZP	--	
1 x 24	ATR124	ATR1X24	ATR124-ZP	ATR1/2X24ZP	
1 x 36	ATR136	ATR1X36	ATR136-ZP	ATR1X36ZP	
1 x 48	ATR148	ATR1X48	ATR148-ZP	--	
1 x 72	ATR172	ATR1X72	--	--	
1-1/8 x 5	ATR1185	--	ATR1185-ZP	--	
1-1/8 x 8	ATR1188	--	ATR1188-ZP	--	
1-1/8 x 10	ATR11810	--	ATR11810-ZP	--	
1-1/8 x 12	ATR11812	--	ATR11812-ZP	--	
1-1/8 x 16	ATR11816	--	ATR11816-ZP	--	
1-1/8 x 18	ATR11818	--	ATR11818-ZP	--	
1-1/8 x 24	ATR11824	--	ATR11824-ZP	--	
1-1/8 x 36	ATR11836	--	ATR11836-ZP	--	
1-1/8 x 48	ATR11848	ATR1-1/8X48	ATR11848-ZP	--	
1-1/8 x 72	ATR11872	--	--	--	

The MiTek CNW coupler nut is designed to join threaded rods to embedded anchor rods. They are also used in the Z4 Tie Down system to attach Z-Rods together (See Z4 Product Catalog). The coupler nut has an inspection hole with an internal positive stop that allows easy verification that the ends of both rods have been fully threaded. The CNW coupler is made from low carbon ASTM A563 Grade A steel (Proof Load = 90 ksi) which makes it applicable for many common ASTM steel threaded rods of equivalent or lower strength.

**Materials:** ASTM A563 Grade A

**Finish:** Zinc Plated

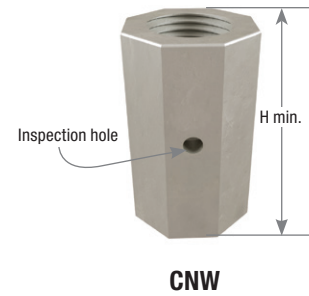
**Codes:** See page 12 for Code Reference Chart

**Installation:**

- Inspection hole is provided to assure easy inspection.
- Tighten rods until they are visible in the inspection hole.
- Works with all thread rods of specified diameter except hot-dip galvanized.

MiTek USP Stock No.	Ref. No.	Dimensions (in)		Allowable Tension (Lbs.) 100%	Code Ref.
		Rod Diameter	H Min		
CNW38-ZP	CNW3/8	0.375	1-1/8	2400	--
CNW12-ZP	CNW1/2	0.500	1-1/4	4265	
CNW58-ZP	CNW5/8	0.625	2-1/8	6675	
CNW34-ZP	CNW3/4	0.750	2-1/4	9610	
CNW78-ZP	CNW7/8	0.875	2-1/2	13080	
CNW1-ZP	CNW1	1.000	2-3/4	17080	
CNW118-ZP	--	1.125	3	<b>21620</b>	

New products or updated product information are designated in **blue font**.



**CNW**



**Typical CNW  
installation**

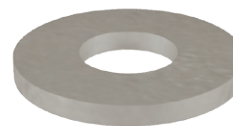
## **RW** Round Washers

Washers are an important component of a threaded rod assembly and should be properly sized for the intended application. They distribute load from the tightened nut and reduce bearing stresses to prevent crushing of the supporting material. This is especially important when tightening over wood.

**Materials:** ASTM/ANSI B18.22

**Finish:** None or Zinc Plated (See Chart)

**Codes:** See page 12 for Code Reference Chart



**RW**

Finish	MiTek USP Stock No.	Ref. No.	Dia. (in)	Code Ref.
None	RW38	--	0.375	--
	RW12	--	0.500	
	RW58	--	0.625	
	RW34	--	0.750	
	RW78	--	0.875	
	RW1	--	1.000	
	RW118	--	1.125	
Zinc Plated	RW38-ZP	--	0.375	
	RW12-ZP	WASHER1/2-ZP	0.500	
	RW58-ZP	WASHER5/8-ZP	0.625	
	RW34-ZP	WASHER3/4-ZP	0.750	
	RW78-ZP	WASHER7/8-ZP	0.875	
	RW1-ZP	WASHER1-ZP	1.000	
	RW118-ZP	WASHER1-1/8-ZP	1.125	

The HN nut is a standard hex nut manufactured from low carbon ASTM A563 Grade A steel (Proof Load = 90 ksi) which makes it applicable for many common ASTM steel threaded rods of equivalent or lower strength.

**Materials:** ASTM A563 Grade A

**Finish:** See chart

**Codes:** See page 12 for Code Reference Chart

**HN**

Finish	MiTek USP Stock No.	Ref. No.	Dia. (in)	Code Ref.	Finish	MiTek USP Stock No.	Ref. No.	Dia. (in)	Code Ref.
None	HN38	--	0.375	--	Zinc Plated	HN38-ZP	NUT3/8	0.375	--
	HN12	--	0.500			HN12-ZP	NUT1/2	0.500	
	HN58	--	0.625			HN58-ZP	NUT5/8	0.625	
	HN34	--	0.750			HN34-ZP	NUT3/4	0.750	
	HN78	--	0.875			HN78-ZP	NUT7/8	0.875	
	HN1	--	1.000			HN1-ZP	NUT1	1.000	
	HN118	--	1.125			HN118-ZP	NUT1-1/8	1.125	

## FT / WG Concrete Form Ties & Wedge

The FT form tie and WG wedge system allows concrete wall forms to be made from 2x nominal form lumber by accurately securing them in place while the concrete is poured. This product is intended for a maximum wall height of 4 feet.

**FT** – Connect 1x and 2x nominal form lumber in low foundation walls up to 4 feet high.

**WG** – V-shaped wedge assures rigidity and consistent form spacing.

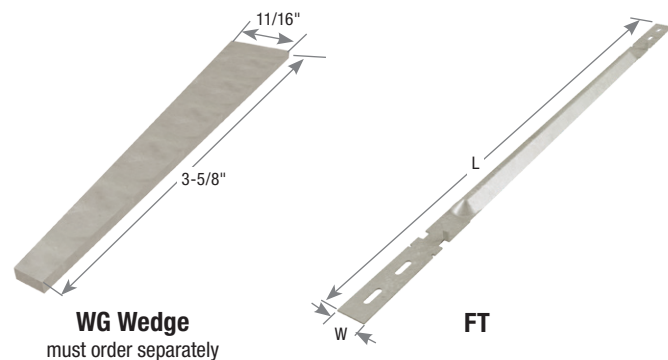
**Materials:** FT – 18 gauge, WG – 14 gauge

**Finish:** G90 galvanizing

**Codes:** See page 12 for Code Reference Chart

### Installation:

- Use the Spacing Guide chart to determine spacing between FT units. Each level in chart assumes 12" form boards. Wall thickness from 6" to 12".
- Install with "V" facing up.
- Use (2) WG wedges for each tie. Insert wedge into inside slots for 1x nominal forms and outside slots for 2x nominal forms.
- No walers or stiff-backs are used.
- Vertical ties to keep forms from separating are not included.
- Form deflection may be substantial. Check deflection, if it is critical, and move ties to compensate.
- Forming lumber is assumed to have fb of 1,000 psi.
- **Not recommended for pours greater than 4 feet in height.**

**Typical FT/WG installation****WG Wedge**  
must order separately**FT**

### Spacing Guide chart

Concrete Lift Height	Level 1		Level 2		Level 3		Level 4	
	1x	2x	1x	2x	1x	2x	1x	2x
12" or Less	2' 6"	4' 0"	--	--	--	--	--	--
12" – 24"	1' 6"	3' 0"	2' 6"	4' 0"	--	--	--	--
24" – 36"	1' 0"	2' 0"	1' 6"	3' 0"	2' 6"	4' 0"	--	--
36" – 48"	0' 9"	1' 6"	1' 0"	2' 0"	1' 6"	3' 0"	2' 6"	4' 0"

1) Factor of safety against tensile failure of tie is 1.5 or more.

MiTek USP Stock No.	Ref. No.	Steel Gauge	Dimensions (in)		Wedge Qty	Footing Width or Wall Thickness	Code Ref.
			W	L			
FT6	WT6	18	5/8	10-5/8	2	6	--
FT8	WT8	18	5/8	12-5/8	2	8	
FT10	WT10	18	5/8	14-5/8	2	10	
FT12	WT12	18	5/8	16-5/8	2	12	
WG	W1	14	1 1/16	3-5/8	--	--	

1) May be used with either 3/4" or 1-1/2" forming materials.

2) Breaking strength is approximately 775 pounds. Space as necessary to prevent form blow-out.

For installation into concrete slabs. The FA3 features a split flange for nailing to both mudsill and stud for greater framing versatility.

**Materials:** 16 gauge

**Finish:** G90 galvanizing

**Options:** See chart for Corrosion Finish Options

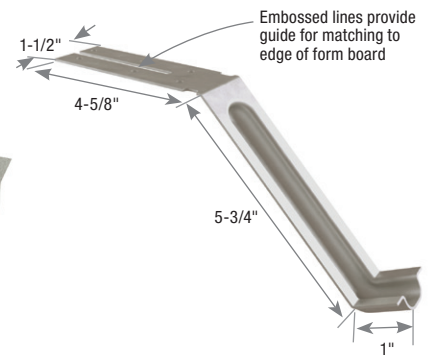
**Codes:** See page 12 for Code Reference Chart

**Installation:**

- Use all specified fasteners. See Product Notes, page 19.
- Use a minimum of two anchors per mudsill. An anchor should always be within 12" of the end of each mudsill section.
- Do not rely on these anchors to secure concrete sections together between cold joints.
- Insert into wet concrete (minimum strength of 2,500 psi). Place mudsill after concrete cures. Secure flanges to sill (and stud, if applicable), bending flanges as needed to achieve a tight fit. Fasten as directed in chart.
- Do not use in red clay brick.



Typical FA3 one-leg-up installation



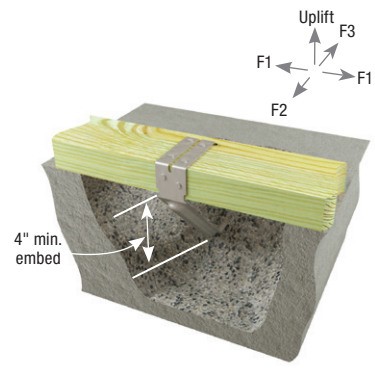
FA3



Typical FA3 form board installation



Alternate FA3 installation



Typical FA3 standard installation in concrete

MiTek USP Stock No.	Ref. No.	Steel Ga.	Plate Size	Fastener Schedule <sup>1,8</sup>				Min Stemwall Thickness (in)	Installation Type	Concrete <sup>7</sup>	DF/SP Allowable Loads (Lbs.) <sup>2,3,5</sup>			Corrosion Finish	Code Ref.	
				Sill Plate		Stud					Type	Uplift 160%	F1 160%			F2 160%
				Side Qty	Top Qty	Qty	Qty									
<b>Wind and SDC A &amp; B</b>																
FA3	--	16	Single 2x	2	4	--	10d x 1-1/2	6	Standard	Uncracked	1410	780	1080	Green	IBC, FL, LA	
				2	2	2				Cracked	985	545	755			
			Single 3x	2	4	--	10d x 1-1/2	6	Standard	Uncracked	--	515	--			
				2	4	--				Cracked	--	475	--			
<b>SDC C-F</b>																
FA3	--	16	Single 2x	2	4	--	10d x 1-1/2	6	Standard	Uncracked	1205	625	925	Green	IBC, FL, LA	
				2	2	2				Cracked	845	470	645			
			Single 3x	2	4	--	10d x 1-1/2	6	Standard	Uncracked	--	515	--			
				2	4	--				Cracked	--	405	--			

- 1) Predrilled holes are not required.
- 2) Allowable Stress Design (ASD) values have been adjusted for a load duration factor, CD, of 1.6 corresponding to a ten-minute load duration (i.e. wind or earthquake loading) in accordance with the NDS. The ASD loads do not apply to loads of other durations.
- 3) FA3 capacities are based on using a single-ply 2x sill plate.
- 4) Minimum distance of 6" is required to obtain the listed capacity.
- 5) Minimum anchor spacing for full capacity is 8". For spacing less than that reduce capacity proportionally.
- 6) Uplift deformation based on wood connection strength.
- 7) Minimum concrete strength f'c = 2,500 psi.
- 8) **NAILS:** 10d x 1-1/2 nails are 0.148" dia. x 1-1/2" long.

**Corrosion Finish** ■ Stainless Steel ■ Gold Coat ■ HDG ■ Triple Zinc

FA4 foundation anchors can be installed as a replacement for 5/8" or 1/2" diameter anchor bolts while achieving the same load capacity.

**Materials:** 16 gauge

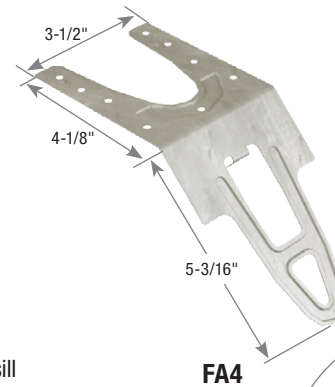
**Finish:** G90 galvanizing

**Options:** See chart for Corrosion Finish Options

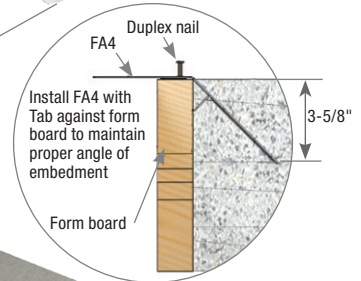
**Codes:** See page 12 for Code Reference Chart

**Installation:**

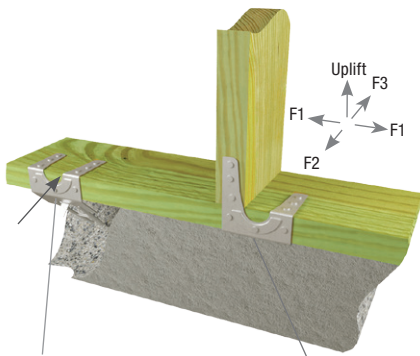
- The FA4 can be mounted to the form board before placing the concrete or inserted into the wet concrete after it is poured. See Detail A installation.
- Place the mudsill in position after the concrete cures. Secure the FA4 to the mudsill (and stud, if applicable) by bending the flanges as needed for a tight fit and nailing into place with the size and quantity of fasteners specified in the chart.



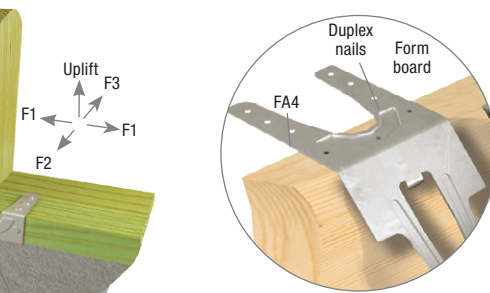
**FA4**



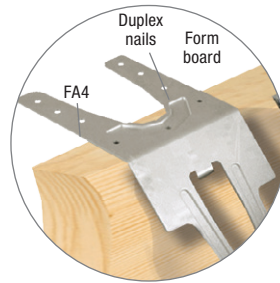
**Detail B**



**Typical FA4 standard installation**



**Typical FA4 one-tab-up installation**



**Detail A**



**Typical FA4 form board installation**

MiTek USP Stock No.	Ref. No.	GA	Plate Size	Fastener Schedule <sup>4</sup>				Installation Type	Concrete <sup>3</sup>	DF/SP Allowable Loads (Lbs.) <sup>1,2</sup>				Corrosion Finish	Code Ref.
				Sill Plate		Stud Qty	Type			Uplift 160%	F1 160%	F2 160%	F3 160%		
				Side Qty	Top Qty										
<b>Wind and SDC A &amp; B</b>															
FA4	MASA	16	Single 2x	3	6	--	10d x 1-1/2	Standard	Uncracked	905	1460	1115	655	IBC, FL, LA	
				3	3	3			Cracked	780	1280	780	610		
			Single 3x	5	4	--	10d x 1-1/2	Standard	Uncracked	780	955	1115	515		
				Cracked	780	955			780	515					
			Varies	9	--	--	10d x 1-1/2	Two-Tabs-Up	Uncracked	1070	1130	--	--		
				Cracked	750	1130			--	--					
<b>SDC C-F</b>															
FA4	MASA	16	Single 2x	3	6	--	10d x 1-1/2	Standard	Uncracked	875	1460	875	655	IBC, FL, LA	
				3	3	3			Cracked	670	1095	670	520		
			Single 3x	5	4	--	10d x 1-1/2	Standard	Uncracked	780	955	875	515		
				Cracked	670	955			670	515					
			Varies	9	--	--	10d x 1-1/2	Two-Tabs-Up	Uncracked	875	1130	--	--		
				Cracked	655	1075			--	--					

- Allowable loads have been increased 60% for wind and seismic loads; no further increase shall be permitted.
- Allowable loads are based on a minimum stemwall thickness of 6", minimum distance from the end of the concrete wall of 4" and minimum anchor spacing of 8".
- Minimum concrete strength f'c = 2,500 psi.
- NAILS:** 10d x 1-1/2" nails are 0.148" dia. x 1-1/2" long.

**Corrosion Finish**

- Stainless Steel
- Gold Coat
- HDG
- Triple Zinc

**Prescriptive Spacing to Replace 1/2" or 5/8" Diameter Bolts**

Anchor Bolt Diameter	Anchor Bolt Spacing	DF/SP 2x Mudsill O.C. Spacing			Hem-Fir 2x Mudsill O.C. Spacing			Min End Distance	Min C-C Spacing
		Wind	SDC A & B	SDC C-E	Wind	SDC A & B	SDC C-E		
1/2"	6'-0"	6'-0"	6'-0"	6'-0"	6'-0"	6'-0"	6'-0"	5-1/2"	7-1/4"
	4'-0"	4'-0"	4'-0"	4'-0"	4'-0"	4'-0"	4'-0"		
5/8"	6'-0"	5'-4"	5'-4"	5'-4"	5'-0"	5'-0"	5'-0"	5-1/2"	7-1/4"
	4'-0"	3'-7"	3'-7"	3'-7"	3'-4"	3'-4"	3'-4"		

- Place anchors not more than 1'-0" from end of each mudsill per code.
- Spacing is based on parallel to mudsill load direction only.
- Concrete shall have a minimum f'c = 2,500 psi.
- Spacing applies to a maximum of 1 in 4 FA4 Foundation Anchors being installed to mudsill and stud.
- Spacing requirements are based on lateral load capacities of anchor bolts published in the 2018 National Design Specification.

**ST1-TZ** – For installation into concrete slab or poured stemwalls.  
The ST1-TZ features a prebent base flange to assure proper anchoring into concrete.

**ST2-TZ** – For installation into concrete slab, poured stemwalls or concrete/masonry.  
The ST2-TZ features a prebent base flange to assure proper anchoring into concrete.

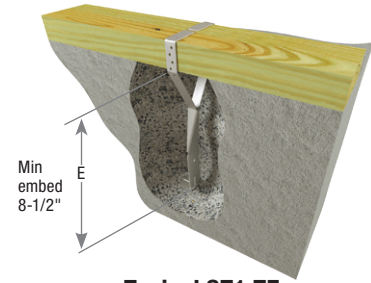
**Materials:** 18 gauge

**Finish:** G-185 galvanizing

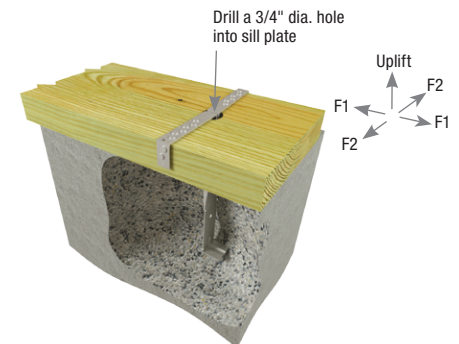
**Codes:** See page 12 for Code Reference Chart

**Installation:**

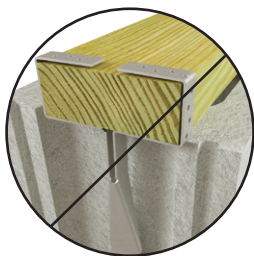
- Use all specified fasteners. See Product Notes, page 20.
- Use a minimum of two anchors per mudsill. An anchor should always be within 12" of the end of each mudsill section. Follow spacing guidelines in chart.
- Do not rely on these anchors to secure concrete sections together between cold joints.
- Spread sill flanges to mudsill width prior to insertion into wet concrete (minimum strength of 2,500 psi). Alternate installation is possible by inserting unbent flanges through 3/4" center hole pre-drilled in mudsill. Foundation anchors may also be attached to mudsill and then inserted into wet concrete. When installing ST2-TZ into concrete block, fill cells with grout with a minimum strength of 2,500 psi. Concrete block edges may need to be beveled to facilitate installation.
- ST2-TZ in masonry construction shall be installed in the core of the block and grouted with concrete grout designed for that purpose. In no case, shall they be installed in a mortar joint.
- Do not use in red clay brick.



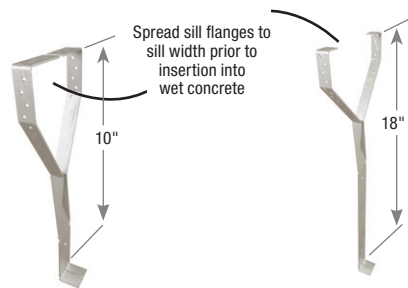
**Typical ST1-TZ installation in concrete**



**Alternate ST1-TZ installation with 3/4" center hole**

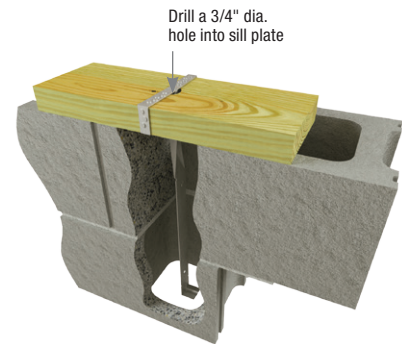


**DO NOT install ST1-TZ and ST2-TZ without pre-bending sill flanges in "Y" configuration**



**ST1-TZ**

**ST2-TZ**



**Alternate ST2-TZ installation with 3/4" center hole in mudsill**

Plate Size	MiTek USP Stock No.	Ref. No.	Steel Gauge	Fastener Schedule <sup>4</sup>				Min. Embed. <sup>3</sup> (E)	Max. Spacing <sup>2</sup> (Feet)	DF/SP Allowable Loads (Lbs.) <sup>1</sup>			Corrosion Finish	Code Ref.
				Mudsill Top		Mudsill Side				Uplift	F1	F2		
				Qty	Type	Qty	Type							
2 x 4 - 6	ST1-TZ	MAB15, MAB15Z	18	4	8d x 1-1/2 HDG	4	8d x 1-1/2 HDG	8-1/2"	*3'-3"	825	565	745		--
	ST2-TZ	--	18	4	8d x 1-1/2 HDG	4	8d x 1-1/2 HDG	16-1/2"	*3'-3"	825	565	745		--

1) Allowable loads have been increased 60% for wind or seismic loads; no further increase shall be permitted.  
 2) Anchor spacing and design loads assume treated Douglas Fir-Larch with Fc perpendicular @ 625 psi; replaces code prescribed 1/2" anchor bolt with standard washer, spaced 6 ft. on center.  
 3) If installed in the alternate configuration, the ST1-TZ shall be embedded 7-1/4" and ST2-TZ 15".  
 4) **NAILS:** 8d x 1-1/2 nails are 0.131" dia. x 1-1/2" long.  
 \*When a 2 x 8 mudsill is used for ST1-TZ or ST2-TZ, maximum spacing is 3 feet unless alternate installation is used.

**Corrosion Finish** ■ Stainless Steel ■ Gold Coat ■ HDG ■ Triple Zinc

# FWAN Foundation Wall Anchor



Concrete & Masonry

MiTek's FWAN-TZ Foundation Wall Anchor is designed to transfer in-plane and out-of-plane foundation wall loads imposed by soil through the joist/blocking into the floor diaphragm. The unique design allows for installations that straddle the joist/blocking eliminating bending stresses in the rim board that result from offset installations.

**The FWAN-TZ offers two methods of installation:**

**1. Centered Installation**

- Compatible with joist/blocking up to 3-1/2" wide
- Highest load capacities for transfer of out-of-plane loads into floor framing
- Rim board splices allowed anywhere along the wall

**2. Offset Installation**

- Installs in the space between the joists/blocking
- Out-of-plane loads are transferred thru the rim board into the floor framing
- Offsets up to 4"

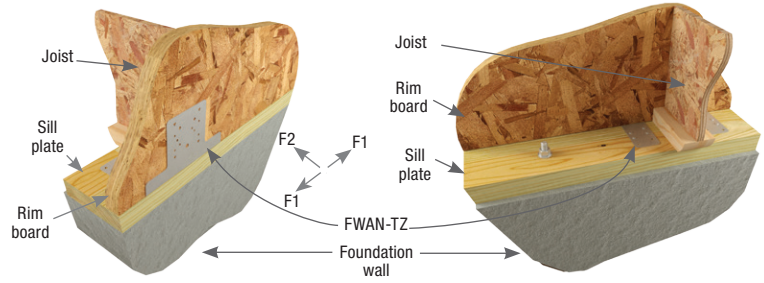
**Materials:** 16 gauge

**Finish:** G-185 galvanizing

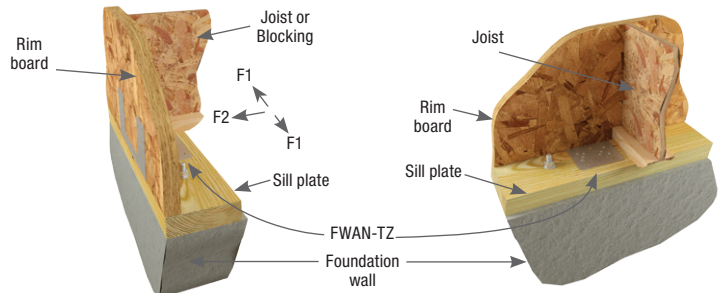
**Codes:** See page 12 for Code Reference Chart

**Installation:**

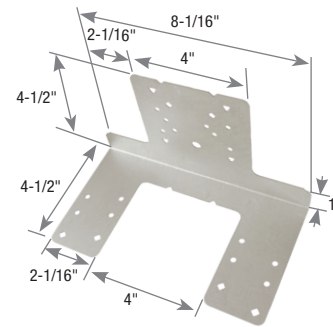
- **Centered Installation** – Fill only triangle holes when nailing to the rim board.
- **Offset Installation** – Fill only diamond holes when nailing to the rim board.
- FWAN-TZ must be installed tight to the outside face of the rim board.
- Minimum sill plate thickness is 1-1/2".
- Offset Installations require that the FWAN-TZ be installed within 4" of the joist/blocking.
- For Offset Installations, install with two narrow tabs against rim board. Splices in the rim board are not permitted in the space between the joists/blocking where the FWAN-TZ is installed.
- The designer must specify the anchor bolt size, spacing and embedment necessary to transfer the foundation loads into the sill plate. Stresses in the sill plate must be considered when determining the maximum spacing of the anchor bolts.



**Centered Installation**  
Typical FWAN-TZ centered on joist/blocking



**Offset Installation**  
Typical FWAN-TZ offset max 4" from joist/blocking



**FWAN-TZ**

MiTek USP Stock No.	Ref. No.	Sill Plate	Fastener Schedule <sup>6</sup>				Rim Board Material	DF/SP Allowable Load (Lbs.) <sup>1,2</sup>						Hem-Fir Allowable Load (Lbs.) <sup>1,2</sup>						Corrosion Finish	Code Ref.
			Sill Plate		Rim Board			F1 <sup>3,4</sup>			F2 <sup>3,4</sup>			F1 <sup>3,4</sup>			F2 <sup>3,4</sup>				
			Qty	Type	Qty	Type		90%	100%	160%	90%	100%	160%	90%	100%	160%	90%	100%	160%		
<b>Centered on Joist/Blocking</b>																					
FWAN-TZ	FWANZ	2x4, 2-2x4, 3x4, 4x4	8	10d x 1-1/2	4	10d x 1-1/2	1-1/8" OSB	440	440	440	915	1000	1135	380	380	380	800	870	990	IBC, FL, LA	
							2x Rim	455	500	550	915	1000	1395	455	480	480	800	870	1215		
							1-3/4" LVL	455	500	550	915	1000	1395	455	480	480	800	870	1215		
		1-1/8" OSB	440	440	440	1370	1500	1520	380	380	380	1200	1310	1325							
		2x Rim	455	500	550	1370	1500	1720	455	480	480	1200	1310	1500							
		1-3/4" LVL	455	500	550	1370	1500	1720	455	480	480	1200	1310	1500							
<b>Offset from Joist Blocking (Max Offset 4")</b>																					
FWAN-TZ	FWANZ	2x4, 2-2x4, 3x4, 4x4	8	10d x 1-1/2	4	10d x 1-1/2	1-1/8" OSB	440	440	440	535	535	535	380	380	380	465	465	465	IBC, FL, LA	
							2x Rim	455	500	550	915	1000	1035	455	480	480	800	870	905		
							1-3/4" LVL	455	500	550	915	1000	1035	455	480	480	800	870	905		
		1-1/8" OSB	440	440	440	535	535	535	380	380	380	465	465	465							
		2x Rim	455	500	550	1035	1035	1035	455	480	480	905	905	905							
		1-3/4" LVL	455	500	550	1035	1035	1035	455	480	480	905	905	905							

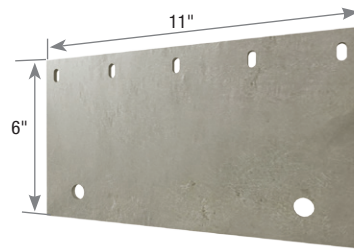
1) Allowable loads have been reduce 10% for permanent sustained loads, no further reduction is required.  
 2) Allowable loads have been increased 60% for wind or seismic loads; no further increase shall be permitted.  
 3) F1 loads are parallel to the sill plate.  
 4) F2 loads are perpendicular toward the sill plate.  
 5) The designer must specify the type, size and spacing of fasteners connecting the sill plate to the foundation wall.  
 6) **NAILS:** 10d x 1-1/2 nails are 0.148" dia. x 1-1/2" long.  
 New products or updated product information are designated in **blue font**.

**Corrosion Finish**  
■ Stainless Steel ■ Gold Coat  
■ HDG ■ Triple Zinc

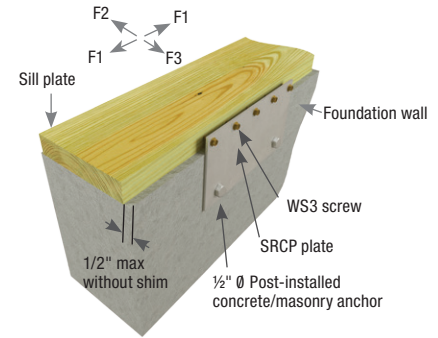
Copyright © 2019 MiTek Industries, Inc. All Rights Reserved



MiTek's SRCP Sill Retrofit Connector Plate is designed as a retrofit sill-to-foundation connection that can be installed where there is minimal space between the floor framing and top of the foundation wall. The economical design is targeted for use in seismic regions and yet is also suitable for use as a supplementary connection in high wind areas. The SRCP Sill Retrofit Connector Plate can be installed without shims anywhere the face of the sill plate is within 1/2" of the face of the foundation wall.

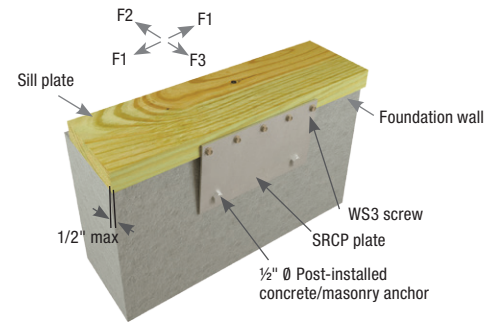


SRCP



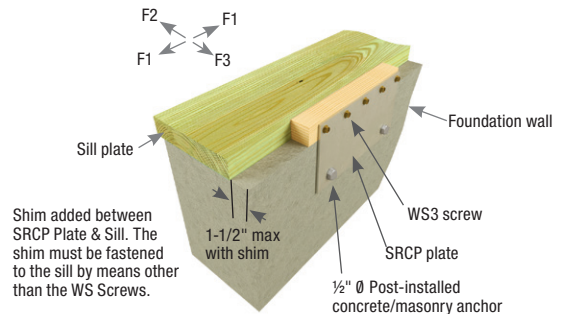
Typical SRCP installation without shim, 1/2" max setback

Figure 1



Typical SRCP installation without shim, 1/2" max overhang

Figure 2



Typical SRCP installation with shim, 1-1/2" max setback

Figure 3

**Materials:** 10 gauge  
**Finish:** G90 galvanizing  
**Codes:** See page 12 for Code Reference Chart

**Installation:**

- For sill plate setbacks from 1/2" to 1-1/2", install a wood shim (a minimum of 15" long) tight against the sill plate and flush with the foundation wall. See Figure 3.  
 Note: For any installations with a sill plate setback, a shim plate is required to transfer load in the F3 direction.
- Install the five WS3 screws (included) in the slotted holes of the SRCP plate, thru the shim (if applicable) and into the sill plate. The WS3 screws should be installed 3/4" above the bottom of the sill plate (i.e. centered in the narrow face for a 2x sill).
- Drill and install two 1/2" diameter Power-Stud® anchors (or equivalent) into the foundation wall. See manufacturer's literature for proper installation of post-installed anchors.

Copyright © 2019 MiTek Industries, Inc. All Rights Reserved

MiTek USP Stock No.	Ref. No.	Steel Gauge	Dimensions (in)		Maximum Spacing to Replace 1/2" or 5/8" Anchor Bolt	Fastener Schedule				Installation Type	DF/SP Allowable Load (Lbs.) <sup>1</sup>			Code Ref.
			W	H		Concrete <sup>3,4</sup>		Sill Plate <sup>2</sup>			F1 160%	F2 160%	F3 160%	
						Qty	Dia.	Qty	Type					
SRCP	FRFP	10	11	6	6'	2	1/2	5	WS3	Figure 1	1570	360	--	--  IBC, FL, LA
										Figure 2	1570	--	360	
										Figure 3 <sup>5</sup>	1570	360	360	

1) Allowable loads have been increased 60% for wind or seismic loads; no further increase shall be permitted.  
 2) WS3 wood screws are 1/4" x 3" and are included with each SRCP connector.  
 3) Use 1/2" diameter Power-Stud® anchors with minimum 3" embedment or equivalent.  
 4) Minimum concrete strength f'c = 2,500 psi.  
 5) The shim must be fastened to the sill by means other than the WS3 wood screws.

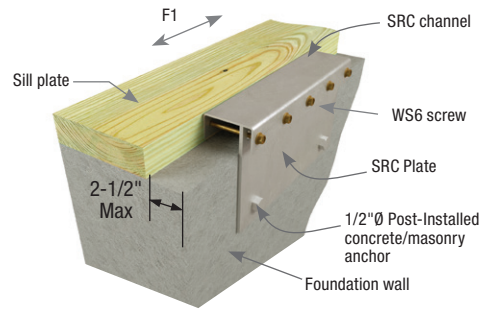
The SRC Sill Retrofit Connector has been engineered as a ductile retrofit for older buildings in high seismic zone regions that require additional reinforcement. It can be installed where there is minimal space between the floor framing and top of the foundation wall. The SRC can also be used to reinforce buildings in high velocity wind zones.

The two-piece design easily adjusts to foundations of varying thickness and can also be used where the sill plate may not be parallel to the face of the foundation wall.

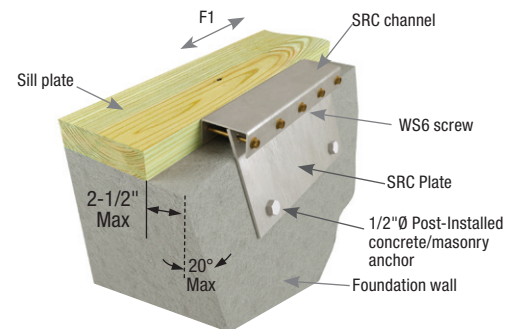
**Materials:** Channel - 12 gauge, Plate - 10 gauge  
**Finish:** G90 galvanizing  
**Codes:** See page 12 for Code Reference Chart

**Installation:**

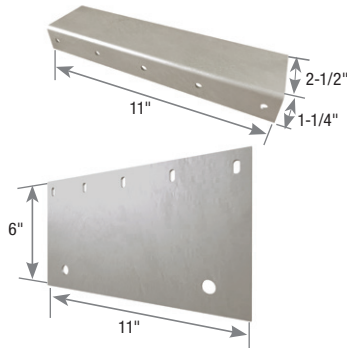
- Use all specified fasteners.
- WS6 wood screws are supplied with each SRC connector.
- **Contact Customer Service for offsets more than 2-1/2".**



**Typical SRC installation on rectangular foundation**

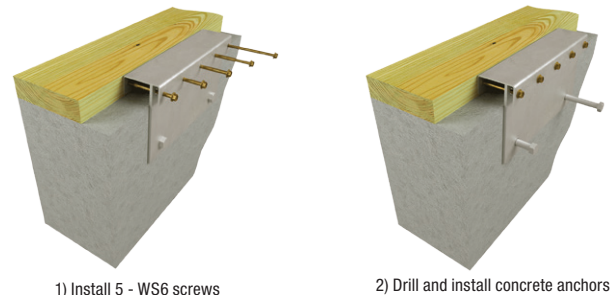


**Typical SRC installation on trapezoidal foundation**



**SRC components**

**Recommended Installation Sequence**



MiTek USP Stock No.	Ref. No.	Components	Steel Gauge	Dimensions (in)		Maximum Spacing to Replace 1/2" or 5/8" Anchor Bolt	Fastener Schedule				DF/SP Allowable Load (Lbs.) <sup>1</sup>	Code Ref.
				W	H		Concrete <sup>3,4</sup>		Sill Plate <sup>2</sup>			
							Qty	Dia.	Qty	Type	F1	
SRC	URFP	Channel	12	11	1-1/4	6'	2	1/2	5	WS6	160%	IBC, FL, LA
		Plate	10	11	6						<b>1450</b>	

1) Allowable loads have been increased 60% for wind or seismic loads; no further increase shall be permitted.  
 2) WS6 wood screws are 1/4" x 6" and are included with each connector.  
 3) Use 1/2" diameter Power-Stud® anchors with minimum 3" embedment or equivalent.  
 4) Minimum concrete strength f'c = 2,500 psi.  
 New products or updated product information are designated in **blue font**.

**SFA** – Mudsill anchors for retrofit applications. Features a slotted bend line for easy adjustment when foundation walls are slanted.

**SFJA** – Ties floor joists directly to foundations with bolt fastening.

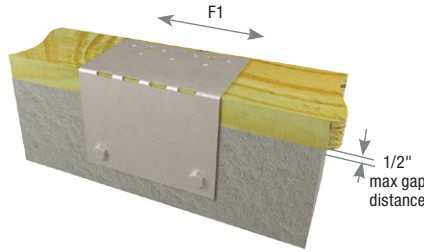
**Materials:** 12 gauge

**Finish:** G90 galvanizing

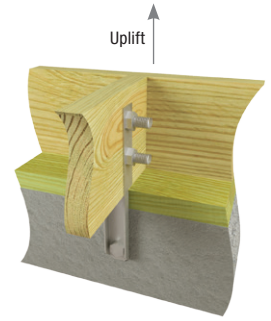
**Codes:** See page 12 for Code Reference Chart

**Installation:**

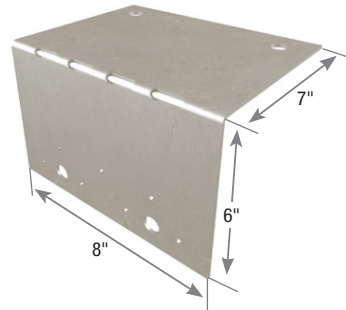
- Use all specified fasteners. See Product Notes, page 20.
- A design professional must specify anchor bolt type, length, and embedment. Anchor bolts are laterally loaded. Follow installation instructions for epoxy adhesive.
- Allowable loads assume a minimum concrete compressive strength of 2,500 psi.



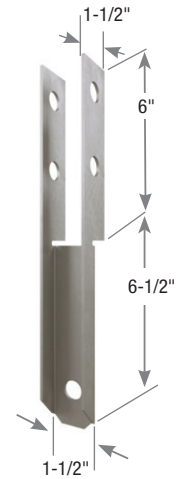
Typical SFA8 installation



Typical SFJA installation



SFA8



SFJA

MiTek USP Stock No.	Ref. No.	Steel Gauge	Fastener Schedule						DF/SP Allowable Loads (Lbs.) <sup>1</sup>		Code Ref.
			Anchor Bolts		Framing				F1	Uplift	
					Nails <sup>3</sup>		Bolts <sup>2</sup>				
Qty	Dia.	Qty	Type	Qty	Dia.	F1	Uplift				
SFJA	FJA	12	1	5/8	--	--	2	5/8	--	1305	--
SFA8	--	12	2	1/2	7	10d x 1-1/2	--	--	875	--	--

1) Allowable loads have been increased 60% for wind or seismic loads; no further increase shall be permitted.

2) All bolts shall meet or exceed the specifications of ASTM A 307.

3) **NAILS:** 10d x 1-1/2 nails are 0.148" diameter by 1-1/2" long.

**RP** Retro Plate

Uses heavy gauge HRPO steel and a large surface area to distribute seismic forces on masonry exteriors.

**Materials:** 3/8" plate

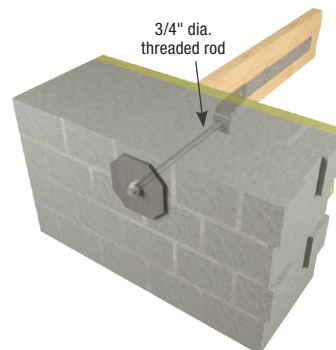
**Finish:** Primer

**Options:** See Chart for Corrosion Finish Options

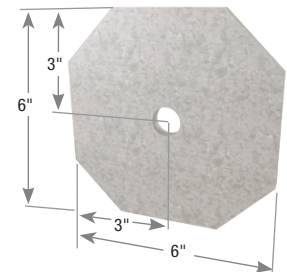
**Codes:** See page 12 for Code Reference Chart

**Installation:**

- Install with a 3/4" diameter steel threaded rod.



Typical RP6 installation



RP6

MiTek USP Stock No.	Ref. No.	Corrosion Finish	Code Ref.
RP6	RP6		--

**Corrosion Finish** ■ Stainless Steel ■ Gold Coat ■ HDG ■ Triple Zinc

**KGLB** – Single bolt, bearing only.

**KGLBT** – Double bolt with structural tee provides uplift and horizontal resistance.

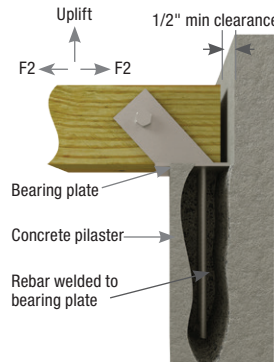
**KHGLB** – Double bolt design provides uplift and horizontal resistance.

**Materials:** Flanges – 1/4" steel  
 Bearing Plate – See chart for "T" dimension  
 Anchor Dowels – 3/4" x 12" rebar

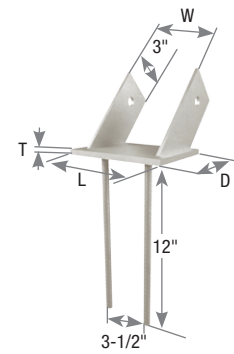
**Finish:** Primer

**Options:** Consult MiTek for non-catalog variations.

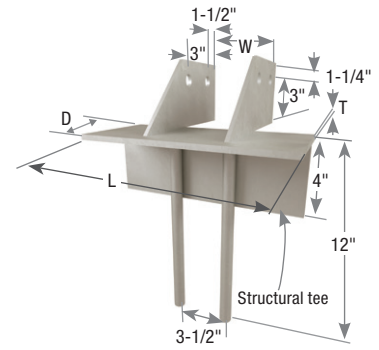
**Codes:** See page 12 for Code Reference Chart



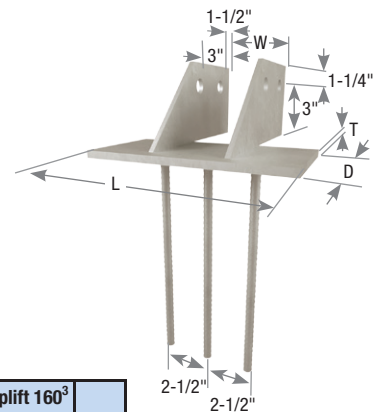
**Typical KGLB installation**



**KGLB**



**KGLBT**



**KHGLB**

**Installation:**

- Use all specified fasteners. See Product Notes, page 20.
- Bolt holes shall be a minimum of 1/32" to a maximum of 1/16" larger than the bolt diameter.
- Concrete or masonry walls must be checked by a design professional for adequacy to resist lateral or uplift loads transferred from the beam seat anchor.

**KGLB Load Table**

MiTek USP Stock No.	Ref. No.	Dimensions (in)				Bolt Schedule		Allowable Bearing Loads (Lbs.) <sup>1,4,5</sup>				Code Ref.
		W	L	T	D	Qty	Dia.	Masonry		Concrete <sup>3</sup>		
								@ 375 psi <sup>2</sup>				
KGLB5A	GLB5A	5-1/4	7	1/4	5	1	5/8	11790	11790		--	
KGLB5B	GLB5B	5-1/4	7	3/8	6	1	5/8	14145	14145			
KGLB5C	GLB5C	5-1/4	7	3/8	7	1	5/8	16505	16505			
KGLB5D	GLB5D	5-1/4	7	3/8	8	1	5/8	18860	18860			
KGLB7A	GLB7A	6-7/8	9	1/4	5	1	3/4	15525	15525			
KGLB7B	GLB7B	6-7/8	9	3/8	6	1	3/4	18630	18630			
KGLB7C	GLB7C	6-7/8	9	3/8	7	1	3/4	21735	21735			
KGLB7D	GLB7D	6-7/8	9	3/8	8	1	3/4	24840	24840			

- 1) Beams must fully bear on plates.
- 2) The loads are based on the bearing value listed times the bearing area equal to W x D. (Note that full bearing plate area is not used.) Bearing loads shall be reduced where limited by wood bearing on the plate.
- 3) The loads on concrete are based on allowable wood bearing stress perpendicular to the grain of 460 psi and actual beam width times beam bearing length.
- 4) Designer shall specify minimum edge and spacing requirements in masonry or concrete structure.
- 5) Concrete or masonry support structure is assumed adequate to support loads listed.

**KHGLB / KGLBT Load Table**

MiTek USP Stock No.	Ref. No.	Dimensions (in)				Bolt Schedule		Allowable Bearing Loads (Lbs.) <sup>1,5</sup>				F <sub>2</sub> <sup>3,4</sup>	Uplift 160 <sup>3</sup>	Code Ref.	
		Range W	D	L	T	Qty	Dia.	On Concrete with Beam Width <sup>2</sup>							
								Masonry @ 375 psi	5-1/8	6-3/4	8-3/4				10-3/4
KHGLBA	HGLBA	3-1/4 to 9	5	10	3/8	2	3/4	18750	11790	15525	20125	--	9870	3905	--
KHGLBB	HGLBB	3-1/4 to 9	6	10	3/8	2	3/4	22500	14145	18630	24150	--	9870	3905	
KHGLBC	HGLBC	3-1/4 to 9	7	10	3/8	2	3/4	26250	16505	21735	28175	--	9870	3905	
KHGLBD	HGLBD	3-1/4 to 9	8	10	3/8	2	3/4	30000	18860	24840	32200	--	9870	3905	
KGLBT512	--	3-1/4 to 11	5-1/4	12	5/16	2	3/4	24750	12965	17080	22140	27200	9870	3905	
KGLBT612	--	3-1/4 to 11	6-1/2	12	3/8	2	3/4	29250	15325	20185	26165	32145	9870	3905	
KGLBT516	--	3-1/4 to 15	5-1/4	16	5/16	2	3/4	27200	12965	17080	22140	27200	9870	3905	
KGLBT616	--	3-1/4 to 15	6-1/2	16	3/8	2	3/4	32145	15325	20185	26165	32145	9870	3905	
KGLBT520	--	3-1/4 to 19	5-1/4	20	5/16	2	3/4	27200	12965	17080	22140	27200	9870	3905	
KGLBT620	--	3-1/4 to 19	6-1/2	20	3/8	2	3/4	32145	15325	20185	26165	32145	9870	3905	

- 1) Beams must fully bear on plates.
- 2) The loads on concrete are based on allowable wood bearing stress perpendicular to the grain of 460 psi and actual beam width times beam bearing length.
- 3) Allowable loads have been increased 60% for wind or seismic loads and are based on bolt in wood values only. Loads assume concrete or masonry structure is adequate to resist loads in those directions.
- 4) Loads must be reduced if the allowable lateral load (F<sub>2</sub>) for masonry or concrete column governs.
- 5) Designer shall specify minimum edge and spacing requirements in masonry or concrete structure.

Connects girder beams to foundation walls and eliminates the need to block out pockets or inserts while forming foundation.

**Materials:** 12 gauge

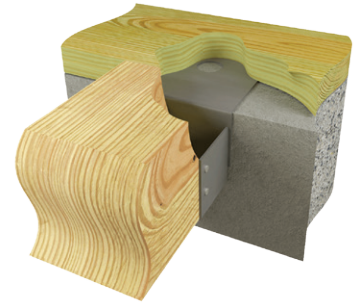
**Finish:** Primer

**Options:** Consult MiTek for non-catalog design variations

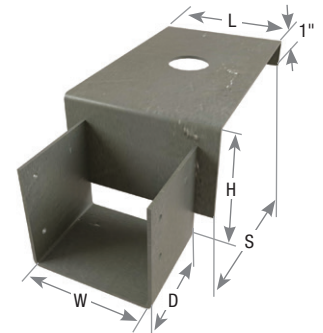
**Codes:** See page 12 for Code Reference Chart

**Installation:**

- Use all specified fasteners. See Product Notes, page 20.
- H dimension assumes 2x mudsill. For 3x or larger mudsill, please contact factory.
- The 1-1/2" hole, centered in the saddle, allows for installation over any protruding foundation bolts. This is not required.
- Placement of a wood sill over the top of the KGH top flange is required to achieve allowable loads.



Typical KGH installation



KGH

Girder Size	MiTek USP Stock No.	Ref. No.	Steel Gauge	Dimensions (in)					Fastener Schedule <sup>1</sup>		DF/SP Allowable Loads (Lbs.)		Code Ref.
				W	L	D	S	H	Qty	Type	100%	125%	
4 x 6	KGH46-6	GH46-6	12	3-9/16	5	3-1/4	6	4	4	16d	2050	2050	IBC, FL, LA
4 x 6	KGH46-8	GH46-8	12				8						
4 x 8	KGH48-6	GH48-6	12	3-9/16	5	3	6	6	4	16d	2050	2050	
4 x 8	KGH48-8	GH48-8	12				8						
6 x 6	KGH66-6	GH66-6	12	5-1/2	6-1/4	3	6	4	4	16d	2035	2035	
6 x 6	KGH66-8	GH66-8	12				8						
6 x 8	KGH68-6	GH68-6	12	5-1/2	6-1/4	3	6	6	4	16d	2035	2035	
6 x 8	KGH68-8	GH68-8	12				8						

1) **NAILS:** 16d nails are 0.162" dia. x 3-1/2" long.

**Specialty Options Chart –**

refer to Specialty Options pages 283 and 285-286 for additional details.

Option	Skewed <sup>1,2</sup>	Saddle
Range	1° to 45°	--
Allowable Loads	100% of table load.	100% of table load per side.
Ordering	Add <i>SK</i> , angle required, right ( <i>R</i> ) or left ( <i>L</i> ), and square cut ( <i>SQ</i> ) or bevel cut ( <i>BV</i> ) to product number. Ex. KGH46-6_SK45R_BV	Add <i>SA</i> , and saddle width required to product number. Ex. KGH46-6_SA=5-1/2"

- 1) Skewed hangers with skews greater than 15° may have all joist nailing on outside flange.
- 2) For skewed hangers, the required cut type (square or bevel) of joist member may vary based on skew angle and width of hanger. Some square cut hangers will require custom pricing due to welded back plate.



KGH saddle Specialty Option

**PHD** holdowns feature the pre-deflected base, minimizing deflection while providing uplift resistance.

**DTB-TZ** is a light capacity holddown for single 2x installations.

**Materials:** See chart

**Finish:** G90 galvanizing; DTB-TZ – G-185 galvanizing

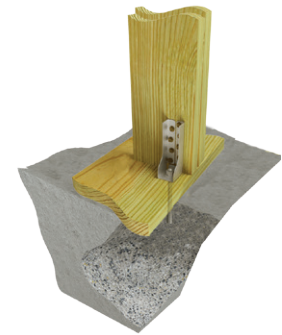
**Codes:** See page 12 for Code Reference Chart

**Installation:**

- Use all specified fasteners. See Product Notes, page 20.
- **Place the PHD over the anchor bolt, no washer is required. Washer is required on DTB installations.**
- Install with MiTek's code evaluated WS15-EXT (1/4" dia. x 1-1/2" long) and WS3 (1/4" dia. x 3" long) Wood Screws, which are provided with the holddown.
- Tighten anchor bolt nuts finger tight to base plus 1/3 to 1/2 additional turns with a wrench.
- **PHD Predeflected Holdowns may be installed off sill plate with no load reduction.** Reference page 68 for more information.
- The design engineer may specify any alternate anchorage calculated to resist the tension load for a specific application. Anchorage exposure length should take the bearing plate height of 1-5/8" into account, anchor bolt thread should visibly extend above nut.
- If used to anchor a built-up post, such as a double 2x4, the post component shall be designed to act as a single unit. Holddown fasteners specified shall not be considered to attach multiple plies together.
- For anchorage options see STB/STBL Anchor Bolt section on pages 47-48.



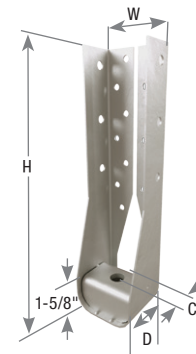
Typical PHD5A installation



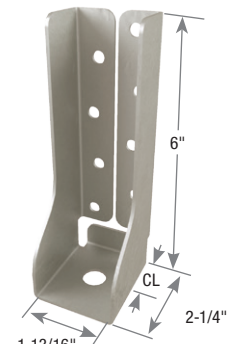
Typical DTB-TZ installation



PHD8



PHD5A



DTB-TZ

Holdowns

MiTek USP Stock No.	Ref. No.	Steel Gauge	Dimensions (in)				Fastener Schedule				Allowable Tension Loads (Lbs.) <sup>1,4,7</sup>			Corrosion Finish	Code Ref.
			W	H	D	CL <sup>8</sup>	Anchor Bolts <sup>2</sup>		Screws <sup>6</sup>		DF/SP 160%	S-P-F 160%	Deflection at Allowable Load Δ (in) at 160% <sup>3,5</sup>		
							Qty	Dia.	Qty	Type					
DTB-TZ	DTT2Z	14	1-13/16	6	2-1/4	1-1/8	1	1/2	8	WS15-EXT	1835	1510	0.119		IBC, FL, LA
PHD2A	HDU2-SDS2.5	14	3	7-3/4	2-5/8	1-3/8	1	5/8	6	WS3	3215	2700	0.155		
PHD4A	HDU4-SDS2.5	14	3	9-3/4	2-5/8	1-3/8	1	5/8	10	WS3	5215	4380	0.137		
PHD5A	HDU5-SDS2.5	14	3	11-11/16	2-5/8	1-3/8	1	5/8	14	WS3	6525	5480	0.135		
PHD8	HDU8-SDS2.5	12	3-1/4	16-1/2	3	1-3/8	1	7/8	24	WS3	8185	6875	0.062		

- 1) Allowable loads have been increased 60% for wind and seismic loads; no further increase shall be permitted.
- 2) The designer must specify anchor bolt type, length, and embedment.
- 3) Deflections are derived from static, monotonic load tests of devices connected to DF-L wood members with specified fasteners.
- 4) The designer shall consider the effect of compression, bearing, tension, and combined bending due to device eccentricity when applicable.
- 5) The PHD/PHDA may be elevated off the sill and may increase deflection. Reference page 68 for more information.
- 6) WS15-EXT Wood Screws are 1/4" dia. x 1-1/2" long, WS3 wood screws are 1/4" dia. x 3" long and are included with holdowns.
- 7) Minimum post thickness is 3". Consult MiTek for installations less than 3".
- 8) "CL" denotes the distance between the post and center of the anchor bolt.

**Corrosion Finish** ■ Stainless Steel ■ Gold Coat ■ HDG ■ Triple Zinc

**LTS series** – The LTS19 is designed for nail-on installation to 2x joists or studs, and the LTS20B provides a nail or bolt fastening option. The LTS20B will accommodate wood I-Joists if 10d x 1-1/2" nails are used instead of the specified 16d nails.

**LTTI31** – An open web joist tension tie designed for use with masonry or concrete construction.

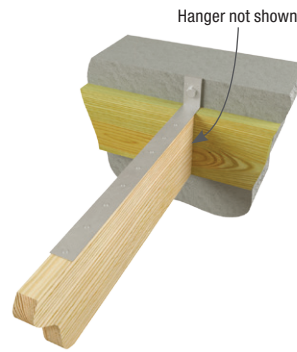
**Materials:** See chart

**Finish:** G90 galvanizing; LTS19-TZ — G-185 galvanizing

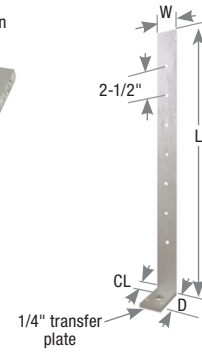
**Codes:** See page 12 for Code Reference Chart

**Installation:**

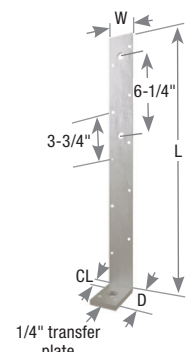
- Use all specified fasteners to attach the strap portion of the connector to the side of stud, post, joist, purlin, or beam. Secure the base to the concrete or masonry wall with specified anchor bolt. A design professional shall specify the type, length, and embedment of the anchor bolt.
- Washers are not required on transfer plates that fit over the anchor bolt.
- LTTI31 and LTS connectors must be mounted flush to the mudsill.
- Allowable loads are based on either nail or bolt fastening; nail and bolt values cannot be combined.
- Tighten anchor bolt nuts finger tight to base plus 1/3 to 1/2 additional turns with a wrench.



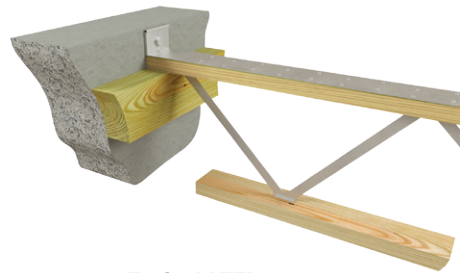
**Typical LTS installation**



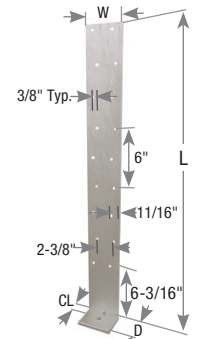
**LTS19-TZ**



**LTS20B**



**Typical LTTI31 installation**



**LTTI31**

Holdowns

MiTek USP Stock No. <sup>6</sup>	Ref. No.	Steel Gauge		Dimensions (in)				Nail Spacing	Fastener Schedule				DF/SP Allowable Tension Loads (Lbs.) <sup>1</sup>		Corrosion Finish	Code Ref.
		Strap	Plate	W	L	D	CL		Anchor Bolt <sup>4</sup>		Strap <sup>2,3,7</sup>		160%	Δ (in) <sup>5</sup>		
									Qty	Dia.	Qty	Type				
LTTI31	LTTI31	18	3	3-3/4	31	2-5/8	1-3/8	3	1	5/8	18	10d x 1-1/2	2805	0.175	IBC, FL	
LTS19-TZ	LTT19	16	3	1-3/4	22-1/4	3	1-1/2	2-1/2	1	3/4	8	10d	1205	0.132		
LTS20B	LTT20B	12	3	2	20	3	1-1/2	3-3/4	1	3/4	10	10d x 1-1/2	1100	0.128		
											2	1/2 Bolt	1175	0.128		

- 1) Allowable loads have been increased 60% for wind or seismic loads; no further increase shall be permitted.
- 2) LTS20B bolted installation requires a minimum 1-1/2" wood member.
- 3) 16d sinkers may be substituted for the specified 10d common nails with no load reduction.
- 4) The designer must specify anchor bolt type, length and embedment depth.
- 5) Deflections are derived from static, monotonic load tests of devices connected to DF wood members with specified fasteners.
- 6) LTTI and LTS holdowns shall be installed tight to the sill plate.
- 7) **NAILS:** 10d x 1-1/2 nails are 0.148" dia. x 1-1/2" long, 10d nails are 0.148" dia. x 3" long, 16d nails are 0.162" dia. x 3-1/2" long.

**Corrosion Finish** ■ Stainless Steel ■ Gold Coat ■ HDG ■ Triple Zinc

Secures multi-ply studs or posts to mudsills or foundation. Nail fastening makes for a convenient connection to studs or posts in cramped retrofit installations.

**Materials:** See chart

**Finish:** G90 galvanizing

**Codes:** See page 12 for Code Reference Chart

**Installation:**

- Use all specified fasteners to attach the strap portion of the connector to the side of stud, post, joist, purlin, or beam. Secure the base to the concrete or masonry wall with specified anchor bolt. A design professional shall specify the type, length, and embedment of the anchor bolt.
- HTT45 Max – Fill all round and diamond nail holes.
- Washers are not required on transfer plates that fit over the anchor bolt.
- Tighten anchor bolt nuts finger tight to base plus 1/3 to 1/2 additional turns with a wrench.
- LL930 (#9 X 2-7/8" long) LumberLok Screws are included with HTT45KT.



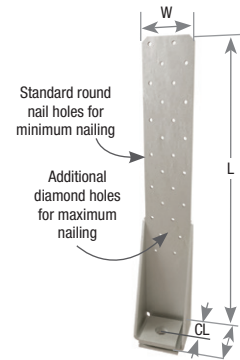
**Typical HTT16 installation**



**Typical HTT45 max installation**



**HTT16**



**HTT45**

Holdowns

MiTek USP Stock No.	Ref. No.	Steel Gauge	Dimensions (in)				Nail Spacing	Fastener Schedule				DF/SP		Code Ref.	
			W	L	D	CL		Min/Max	Anchor Bolt <sup>3</sup>		Strap <sup>2,3,7</sup>		Allowable Tension Loads (Lbs.) <sup>1</sup>		
									Qty	Dia.	Qty	Type	160%		Δ (in) <sup>4,5</sup>
HTT16	HTT4	10	2-1/2	16	2	1-3/8	1-3/4	--	1	5/8	18	10d	3610	0.142	IBC, FL, LA
HTT45	HTT4, HTT5	10	2-1/2	16	2	1-3/8	1-3/4	Min	1	5/8	18	10d	4215	0.115	
								Max	1	5/8	26	16d x 2-1/2	4160	0.108	
HTT45KT <sup>6</sup>	HTT5KT	10	2-1/2	16	2	1-3/8	1-3/4	--	1	5/8	26	LL930	5865	0.113	

- 1) Allowable loads have been increased 60% for wind or seismic loads; no further increase shall be permitted.
- 2) 16d sinkers may be substituted for the specified 10d common nails with no load reduction.  
16d common nails may be substituted for the specified 16d x 2-1/2" nails with no load reduction.
- 3) The designer must specify anchor bolt type, length and embedment depth.
- 4) Deflections are derived from static, monotonic load tests of devices connected to DF wood members with specified fasteners.
- 5) HTT holdowns raised off of the sill plate may have higher deflection values.
- 6) HTT45KT is sold as a kit and includes (1) HTT45 and (26) LL930 screws.
- 7) **NAILS:** 10d nails are 0.148" dia. x 3" long, 16d x 2-1/2" nails are 0.162" dia. x 2-1/2" long.



**TD** – Different welded configurations and sizes achieve a great deal of versatility within the TD series.

**TDX** – The TDX2 and TDX5 feature formed designs, all others are welded. All are self-jigging.

**All models, except TD2, TD5, and TD7, feature a self-jigging design with code required end distances built in. (End distance = 7 bolt diameters from the top of the sill to the center of the first bolt hole in the studs or post.)**

**Materials:** See chart

**Finish:** TDX2-TZ – G-185 galvanizing; All others – Primer

**Codes:** See page 12 for Code Reference Chart

**Patents:** U.S. Patent No. 5,092,097 — TDX2

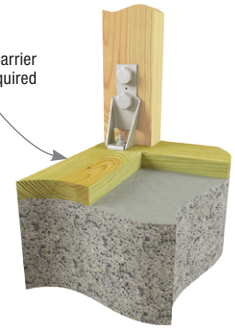
**Installation:**

- Use all specified fasteners. See Product Notes, page 20.
- Do not use lag bolts. Washers are not required for anchor bolts or between holdown and bolt hex head, but standard washers should be used against stud or post under the nut. See page 37 for BP/LBP Bearing Plates.
- Bolt holes should be a minimum of 1/32" to a maximum of 1/16" larger than the bolt diameter (as per NDS® specifications).
- See pages 47-48 for STB Anchor Bolt section for anchorage options. A design professional may specify alternate anchorage with conventional anchor bolts.
- A design professional shall determine the adequacy of the stud to resist published loads. Holdown fasteners specified shall not be considered to attach multiple plies together.
- Self-jigging models are designed to provide the required minimum end distance of 7 bolt diameters from the bottom of the stud or post to the centerline of the first bolt hole.
- Tighten anchor bolt nuts finger tight to base plus 1/3 to 1/2 additional turns with a wrench. Wood members may shrink over time; if possible, nut tightness should be checked periodically.
- If used to anchor a built-up post, such as a double 2x4, the post component shall be designed to act as a single unit.

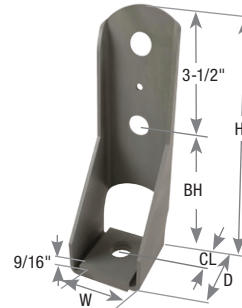


**Typical TDX6 installation**

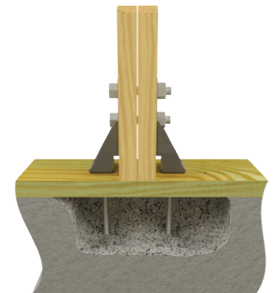
Moisture barrier may be required



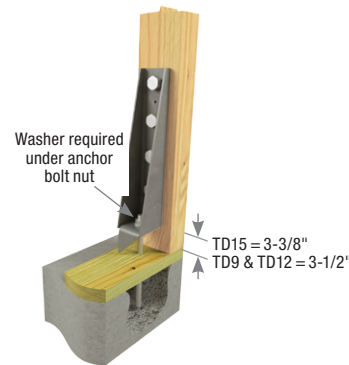
**Typical TDX2-TZ installation**



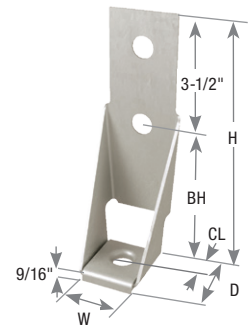
**TDX6**



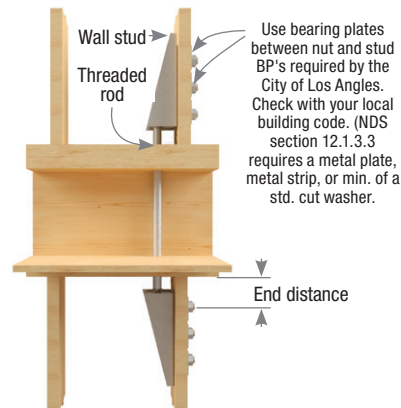
**Typical TDX2-TZ back-to-back installation**



**Typical TD15 installation**



**TDX2-TZ**



**Holdown installation between floors**

MiTek USP Stock No. <sup>11</sup>	Ref. No.	Steel Gauge	Dimensions (in)					Fastener Schedule <sup>4</sup>			Min. Required Bolt End Distance <sup>5</sup>	Length of Bolt in Vertical Member	DF/SP Allowable Tension Loads (Lbs.) <sup>1,2,3</sup>		Corrosion Finish	Code Ref.
			W	H	D	BH	CL	Anchor Bolt Dia.	Bolts				160%	Δ (in)		
									Qty	Dia.						
TD5	--	7	3	6-3/8	3-3/4	1-1/4	2-1/8	3/4	2	3/4	5-1/4	1-1/2"	2405	0.122 <sup>6</sup>	IBC, FL, LA	
												3"	4040	0.140 <sup>6</sup>		
												3-1/2"	4040	0.140 <sup>6</sup>		
												5-1/2"	4040	0.140 <sup>6</sup>		
TD7	--	3	3-3/8	11-7/8	3-5/8	3-3/8	2-1/8	1-1/8	3	7/8	6-1/8	1-1/2"	4600	0.095 <sup>6</sup>	IBC, FL	
												3"	8195	0.125 <sup>6</sup>		
												3-1/2"	9420	0.139 <sup>6</sup>		
												5-1/2"	10510	0.152 <sup>6</sup>		
TD9	--	3	3-3/8	16-1/2	4-1/4	4-1/8	2-1/8	1-1/8	3	1	7	3"	9330	0.146 <sup>6</sup>	IBC, FL	
												3-1/2"	10715	0.160 <sup>6</sup>		
												4-1/2"	13370	0.169 <sup>6</sup>		
												5-1/2"	13500	0.170 <sup>6</sup>		
TD12	HD12	3	3-1/2	20-1/2	4-1/4	4-1/8	2-1/8	1-1/8	4	1	7	3"	12070	0.132 <sup>6</sup>	IBC, FL, LA	
												3-1/2"	13960	0.142 <sup>6</sup>		
												4-1/2"	16550	0.185 <sup>6</sup>		
												5-1/2"	16550	0.185 <sup>6</sup>		
TD15	HD19	3	3-1/2	25	4-3/8	4-1/4	2-1/8	1-1/4	5	1	7	3"	14505	0.167 <sup>6</sup>	IBC, FL, LA	
												3-1/2"	16845	0.178 <sup>6</sup>		
												4-1/2"	20710	0.155 <sup>6</sup>		
												5-1/2"	20390	0.153 <sup>6</sup>		
TDX2-TZ	HD3B	12	2-1/16	8-1/8	2-3/4	4-1/2	1-1/2	5/8	2	5/8	4-1/2	1-1/2"	1920	0.150 <sup>6</sup>	IBC, FL, LA	
												3"	3295	0.169 <sup>6</sup>		
												3-1/2"	3295	0.169 <sup>6</sup>		
												5-1/2"	3295	0.169 <sup>6</sup>		
TDX5	--	10	2-1/2	9-3/8	3-7/8	6	2	3/4	2	3/4	5-1/4	1-1/2"	2340	0.079 <sup>6</sup>	IBC, FL, LA	
												3"	4515	0.151 <sup>6</sup>		
												3-1/2"	4530	0.151 <sup>6</sup>		
												4-1/2"	4530	0.151 <sup>6</sup>		
TDX6	HD5B	7	3-1/2	11-1/8	3-3/4	6-1/8	2	7/8	2	7/8	6-1/8	1-1/2"	2835	0.093 <sup>6</sup>	IBC, FL, LA	
												3"	5350	0.128 <sup>6</sup>		
												3-1/2"	5805	0.138 <sup>6</sup>		
												4-1/2"	5805	0.138 <sup>6</sup>		
TDX8	--	7	3-1/2	14-5/8	3-3/4	6-1/8	2	7/8	3	7/8	6-1/8	1-1/2"	4160	0.060 <sup>6</sup>	IBC, FL, LA	
												3"	7870	0.132 <sup>6</sup>		
												3-1/2"	9125	0.172 <sup>6</sup>		
												4-1/2"	9125	0.172 <sup>6</sup>		
TDX10	HD7B	7	3-1/2	18-1/8	3-3/4	6-1/8	2	7/8	4	7/8	6-1/8	3"	10140	0.128 <sup>6</sup>	IBC, FL, LA	
												3-1/2"	10570	0.137 <sup>6</sup>		
												4-1/2"	10570	0.137 <sup>6</sup>		
												5-1/2"	10570	0.137 <sup>6</sup>		
TDX14	HD9B	3	3-1/2	20-1/2	3-5/8	7	2-1/8	1	4	1	7	3"	11995	0.117 <sup>6</sup>	IBC, FL, LA	
												3-1/2"	13895	0.146 <sup>6</sup>		
												4-1/2"	15015	0.166 <sup>6</sup>		
												5-1/2"	15015	0.166 <sup>6</sup>		

- 1) Allowable loads shown are for single shear connections and may be doubled for back-to-back installations. The designer must verify post and anchor bolt capacities.
- 2) Allowable loads have been increased 60% for wind or seismic loads; no further increase shall be permitted.
- 3) The designer must specify stud or post to resist published load values.
- 4) The designer must specify anchor bolt type, length, and embedment.
- 5) TD models - install TD holdown raised off of bottom plate if the BH dimension is less than end distance dimension.
- 6) Deflections are derived from static, monotonic load tests of devices connected to DF wood members and consider both the deflection of the holdown and cross grain crushing of the wood post.
- 7) The designer shall consider the effect of compression, bearing, tension, and combined bending due to device eccentricity when applicable.

Corrosion Finish ■ Stainless Steel ■ Gold Coat ■ HDG ■ Triple Zinc

Engineered for high capacity with minimum deflection and low eccentricity.

**Materials:** See chart

**Finish:** Primer

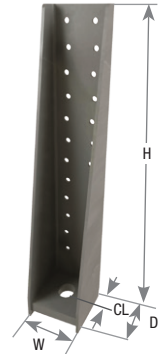
**Codes:** See page 12 for Code Reference Chart

**Installation:**

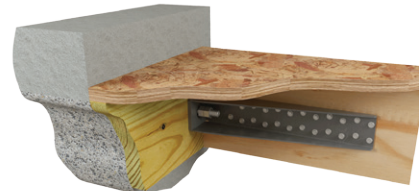
- Use all specified fasteners. See Product Notes, page 20.
- Place holdown over anchor bolt and drive screws into post.
- Tighten anchor bolt nuts finger tight to base plus 1/3 to 1/2 additional turns with a wrench.
- Holdown may be installed off of the plate with no load reduction. Reference page 68 for more information.
- If used to anchor a built-up post, such as a double 2x4, the post component shall be designed to act as a single unit. Holddown fasteners specified shall not be considered to attach multiple plies together.



**Typical UPHD installation**



**UPHD**



**Typical UPHD concrete wall installation**

MiTek USP Stock No.	Ref. No.	Steel Gauge	Dimensions (in)				Fastener Schedule		DF/SP Allowable Loads (Lbs.)		S-P-F Allowable Loads (Lbs.)	Code Ref.
			W	H	D	CL	Anchor Bolt Dia. <sup>2</sup>	WS3 Wood Screws <sup>6</sup>	Tension <sup>1,5,7</sup>		Tension <sup>1,5,7</sup>	
									160%	Δ (in)	160%	
										at 160% <sup>3,5</sup>		
UPHD8	HDQ8-SDS3	10	3-1/4	17-1/2	3-1/8	1-3/8	7/8	24	9165	0.075	7695	IBC, FL, LA
UPHD9	HDU11-SDS2.5	10	3-1/4	17-1/4	3-1/2	1-1/2	1	24	11270	0.057	9465	
UPHD11	HHDQ11-SDS2.5	7	3	15-1/8	3-1/2	1-1/2	1	24	14395	0.077	12090	
UPHD14	HDU14-SDS2.5, HHDQ14-SDS2.5	7	3	18-3/4	3-1/2	1-1/2	1	30	16695	0.082	14020	

1) Allowable loads have been increased 60% for wind and seismic loads; no further increase shall be permitted.  
 2) The designer must specify anchor bolt type, length, and embedment.  
 3) Deflections are derived from static, monotonic load tests of devices connected to DF-L wood members with specified fasteners.  
 4) The designer shall consider the effect of compression, bearing, tension, and combined bending due to device eccentricity when applicable.  
 5) The UPHD may be elevated off the sill and may increase deflection. Reference page 68 for more information.  
 6) WS3 wood screws are 1/4" dia. x 3" and are included with UPHD models.  
 7) Minimum post thickness is 3" or greater. Consult MiTek for installations less than 3".

# Holddown Offset Anchor Bolt Notes

Allowable loads and deflection values for holdowns such as TD, PHD, TDX, HTT and UPHD are based on installation with the anchor bolt aligned directly below the centerline of the holddown. The maximum tolerances for anchor bolt offset are described below.

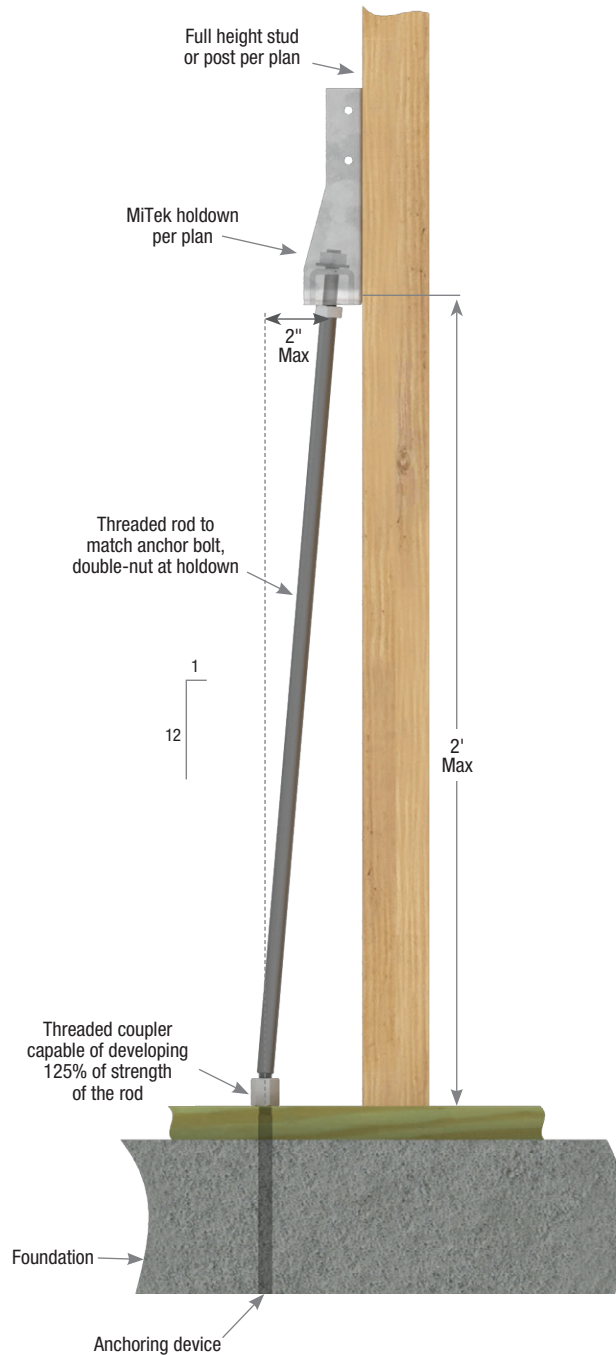
Designer should consider that installation of a holddown raised above the sill plate may result in higher deflections. These deflections are different for every installation and should be calculated by a certified designer.

**Installation:**

- Holddown installed at maximum of 2' above the bottom plate.
- Anchor bolt installed at maximum 2" away from the centerline of the holddown.
- Threaded rod angle must not exceed 5 degrees or a pitch of 1/12.
- A threaded coupler must be used at the anchor bolt connection capable of developing 125% of strength of the rod.

**Alternate installations:**

1. Install additional full-height member(s) to the existing stud(s) or post to reduce the horizontal distance between the anchor bolt and the vertical member(s).
  - Multi-ply studs/posts must be fastened together to act as a single unit. Holddown fasteners must not be considered to contribute to fastening multiple members together.
  - Added members shall be of equal or better wood species.
  - Designer must consider any effect of additional eccentricity introduced on the connection.
2. Using a threaded rod epoxied into place at the proper location in lieu of cast-in anchor bolts. These can be installed after the rough framing is completed.



Designed to anchor wood framing to poured concrete foundations.

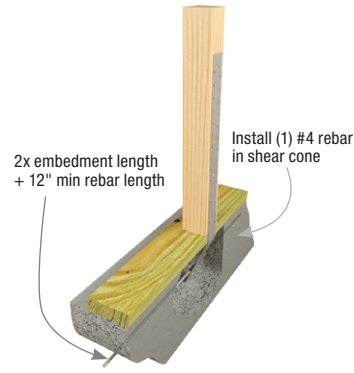
**Materials:** See chart

**Finish:** G90 galvanizing

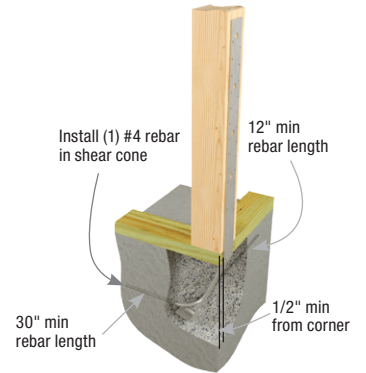
**Codes:** See page 12 for Code Reference Chart

**Installation:**

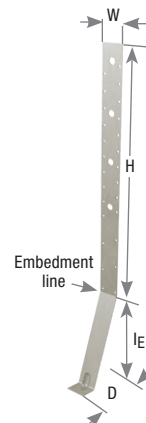
- Use all specified fasteners. See Product Notes, page 20.
- Bending the strap horizontally 90° to facilitate wall placement may cause concrete behind the embedded strap to break away at the top edge (spalling). If the spall is 1" or less from the top edge of the concrete, no load reduction is necessary. If the spall is between 1" and 4", the allowable load is 0.90 of the published chart load.
- When installing on lumber less than 3-1/2" wide, wood splitting may occur. To reduce splitting, use 10d x 1-1/2" nails or fill every other hole with 16d common nails. Reduce allowable loads in accordance with code requirements.
- Straps are to be installed at the edge of concrete. Install prior to pour by nailing to form. Drive temporary nails through lowest two nail holes into form. Concrete level should reach embedment line; minimum embedment depths are listed in chart.
- Do not rely on these straps to secure concrete sections together between cold joints; take other measures to transfer the load. If there is a cold joint between slab and foundation, the minimum embedment must be made into the foundation. Fastening opportunities may be reduced because the slab pour level may be higher than some nail holes. Using fewer fasteners will reduce allowable loads. Reduce allowable load by the code capacity for each fastener not installed.
- Allowable loads based on a minimum concrete compressive strength of 2,500 psi at 28 days, with one #4 horizontal rebar in the shear cone. Rebar should be a minimum length of 2x embedment depth plus 12" (see chart for exceptions in corner installations).
- Where fewer fasteners are used in the structural wood member, reduce loads according to the code.
- There may be an increase in the amount of deflection if the strap is installed on the outside of the sheathing, versus directly to the framing members.
- Strap may be bent one complete cycle to aid installation.



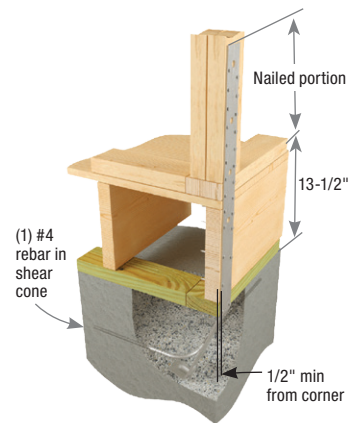
**Typical HPAHD22 single pour edge installation**



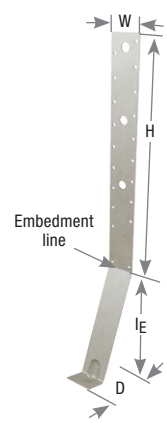
**Typical HPAHD22 single pour corner and endwall installation**



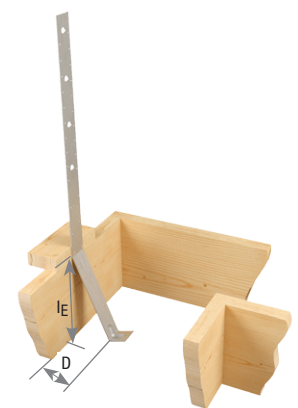
**HPAHD**



**Typical HPAHD22 single pour rim joist installation**



**PAHD42**

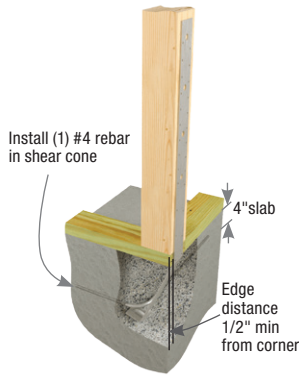


**HPAHD22 form board installation**

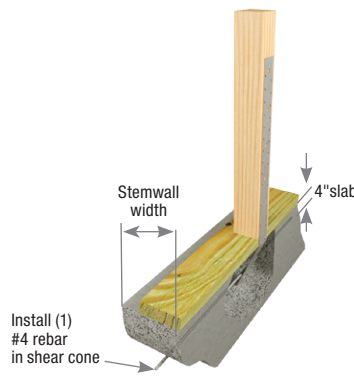
**HPAHD22 / PAHD42 Load Table**

MiTek USP Stock No.	Ref. No.	Steel Ga.	Fastener Schedule <sup>1,11</sup>		Dimensions (in)				Min Stemwall Thickness (in)	Edge Distance <sup>3,4</sup>	Concrete <sup>8,9</sup>	DF/SP Allowable Tension Loads (Lbs.) <sup>2</sup>			Code Ref.
			Qty	Type	W	H	I <sub>E</sub>	D				Concrete Connection Strength	Wood Connection Strength CD = 1.6	Deflection at Allowable Load Based on Wood Connection Strength (in.) <sup>7</sup>	
<b>Wind<sup>5,6,7</sup> and SDC A &amp; B</b>															
HPAHD22	--	10	23	16d	2-1/16	24-3/4	9-1/2	4-1/8	6	1/2"	Uncracked	3300	3830	0.118	IBC, FL, LA
											Cracked	2310			
										1.5 x I <sub>E</sub>	Uncracked	3460	3830	0.118	
											Cracked	2425			
PAHD42	--	12	15	16d	2-1/16	16-5/8	8	5-3/4	6	1/2"	Uncracked	1225	2065	0.095	
											Cracked	855			
										1.5 x I <sub>E</sub>	Uncracked	2610	2065	0.095	
											Cracked	1830			
<b>SDC C-F</b>															
HPAHD22	--	10	23	16d	2-1/16	24-3/4	9-1/2	4-1/8	6	1/2"	Uncracked	2635	3830	0.118	IBC, FL, LA
											Cracked	1980			
										1.5 x I <sub>E</sub>	Uncracked	2965	3830	0.118	
											Cracked	2075			
PAHD42	--	12	15	16d	2-1/16	16-5/8	8	5-3/4	6	1/2"	Uncracked	1050	2065	0.095	
											Cracked	735			
										1.5 x I <sub>E</sub>	Uncracked	2140	2065	0.095	
											Cracked	1565			

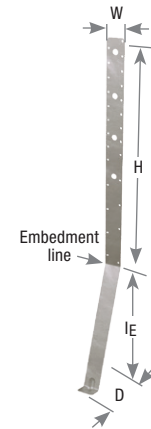
- 1) Predrilled holes are not required.
- 2) The lesser of the allowable load based on anchorage to concrete or wood connection strength must be selected.
- 3) An edge distance of 1/2" implies that the distance from the corner of the wall to the edge of the strap is no less than 1/2".
- 4) An edge distance of 1.5 x I<sub>E</sub> implies that the minimum distance from the corner of the wall to the centerline of the strap is no less than 1.5 times the embedment depth.
- 5) For edge distances between 1/2" and 1.5 x I<sub>E</sub> calculate loads using straight line interpolation.
- 6) Minimum anchor spacing for full capacity is 2 x I<sub>E</sub>. For spacing less than that reduce capacity proportionally.
- 7) Deformation based on wood connection strength.
- 8) Minimum concrete strength f'c = 2,500 psi.
- 9) Minimum 1-#4 rebar shall be installed in the shear cone.
- 10) **NAILS:** 16d nails are 0.162" dia. x 3-1/2" long.



**Typical HPAHD22-2P double pour corner installation**



**Typical HPAHD22-2P double pour edge installation**



**HPAHD22-2P**

**HPAHD22-2P Load Table**

MiTek USP Stock No.	Steel Gauge	Dimensions (in)				Installation Type	Stemwall Width	Fastener Schedule <sup>2,5</sup>		DF/SP Allowable Tension Loads (Lbs.) <sup>1</sup>	Code Ref.
		W	H	I <sub>E</sub>	D			Min Qty <sup>4</sup>	Nail		
<b>EDGE INSTALLATION - 2,500 psi Concrete</b>											
<b>Double Pour Edge Installation - 8" min from corner</b>											
HPAHD22-2P	10	2-1/16	26-1/4	14	6-1/4	Figure 5	6	24	16d	5170	--
							8				
<b>CORNER INSTALLATION - 2,500 psi Concrete</b>											
<b>Double Pour Edge Installation - 1/2" min from corner</b>											
HPAHD22-2P	10	2-1/16	26-1/4	14	6-1/4	Figure 4	6	24	16d	4095	--
							8				

- 1) Allowable loads have been increased 60% for wind or seismic loads; no further increase shall be permitted.
- 2) 16d sinkers (0.148" dia. x 3-1/4" long) or 10d common (0.148" dia. x 3" long) nails may be substituted for the specified 16d common nails provided the listed allowable loads are reduced 15%.
- 3) Rim joist application; see Figure 3 for corner condition.
- 4) Minimum quantity of fasteners to be installed. Product may have additional nail holes not needed to meet published allowable load of product.
- 5) **NAILS:** 16d nails are 0.162" dia. x 3-1/2" long. New products or updated product information are designated in **blue font**.

The coined dimples below the embedment line allow for increased concrete bonding. These holdowns retain high uplift capacity even when installed at corners of foundation stemwalls. Ideal for use with built up 2x end posts.

RJ after the model indicates LSTAD or STAD for rim joist applications as in **STAD8RJ**. Rim joist models provide for a 17" clear span without the loss of strap nailing.

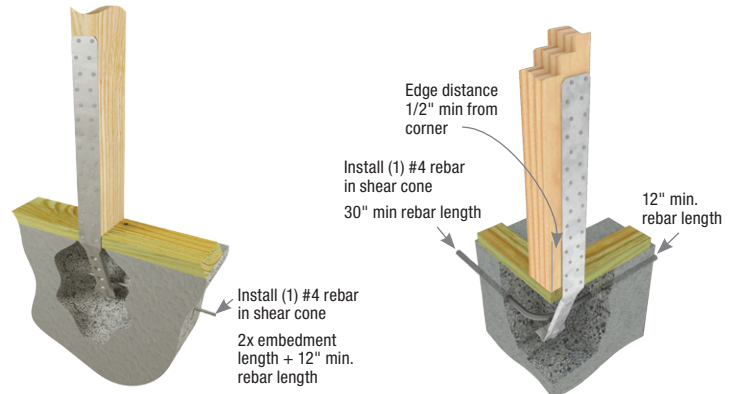
**Materials:** LSTAD-14 gauge; STAD-12 gauge

**Finish:** G90 galvanizing

**Codes:** See page 12 for Code Reference Chart

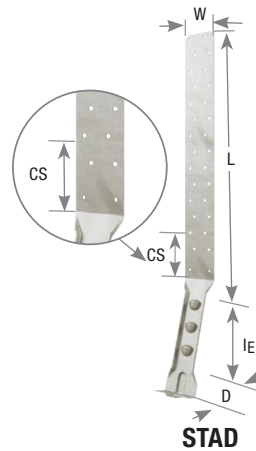
**Installation:**

- Use all specified fasteners. See Product Notes, page 20. The bottom (2) nails are for form board attachment only and do not contribute to fastener schedule requirements.
- Embed holdown in concrete to the embedment line (bend line).
- See illustrations for requirements on rebar, edge distances, and clear spans.
- Bending the strap horizontally 90° to facilitate wall placement may cause concrete behind the embedded strap to break away at the top edge (spalling). If the spall is 1" or less from the top edge of the concrete, no load reduction is necessary. If the spall is between 1" and 4" the allowable load is 0.90 of the published chart load.
- When installing on lumber less than 3-1/2" wide, wood splitting may occur. To reduce splitting, use 10d x 1-1/2" nails or fill every other hole with 16d common nails. Reduce allowable loads per code requirements accordingly.
- These straps do not secure concrete sections together at cold joints; take other measures to transfer the load. If there is a cold joint between slab and foundation, the minimum embedment must be made into the foundation. Fastening opportunities may be reduced because the slab pour level may be higher than some nail holes. Using fewer fasteners will reduce allowable loads. Reduce allowable load by the code capacity for each fastener not installed.
- To achieve full table loads the minimum center-to-center spacing is twice the embedment depth (IE) when resisting tension loads at the same time.
- Where fewer fasteners are used in the structural wood member, reduce loads according to the code.
- There may be an increase in the amount of deflection if the strap is installed on the outside of the sheathing, versus directly to the framing members.
- Strap may be bent one complete cycle to aid installation.

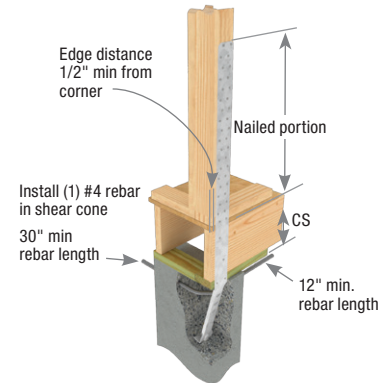


**Typical STAD10 middle wall installation**

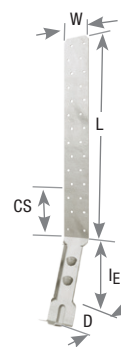
**Typical STAD10 corner installation**



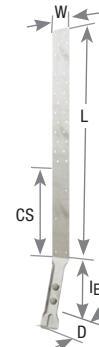
**STAD**



**Typical STAD14RJ corner rim joist installation**



**LSTAD**



**STAD\_RJ**

MiTek USP Stock No.	Ref. No.	Ga.	Dimensions (in)				Min Stem Wall (in)	Fastener Schedule <sup>1,12</sup>		Allowable Tension Loads (Lbs.) <sup>6,7</sup>				Code Ref.	
			W	L	I <sub>E</sub>	D		CS	Qty <sup>8</sup>	Type	Uncracked		Cracked		
											Corner <sup>3</sup>	Middle <sup>4,5</sup>	Corner <sup>3</sup>		Middle <sup>4,5</sup>
<b>Wind and SDC A &amp; B - Allowable Tension Loads (Lbs.)</b>															
LSTAD8	LSTHD8	14	3	21-5/8	8	5	4-5/8	6	16	16d Sinker	2280	3125	1820	3125	130
LSTAD8RJ	LSTHD8RJ			35-1/8											
STAD8	--	12	3	21-5/8	8	5	4-5/8	6	18	16d Sinker	2265	3705	1905	3175	13, R2, F33
STAD8RJ	--			35-1/8											
STAD10	STHD10	12	3	21-5/8	10	5	1-5/8	6	24	16d Sinker	3135	5105	2540	4480	
STAD10RJ	STHD10RJ			36											
STAD14	STHD14	12	3	32-1/8	14	5	4-5/8	6	28	16d Sinker	4745	5260	4745	5260	
STAD14RJ	STHD14RJ			39-5/8											
<b>SDC C thru F - Allowable Tension Loads (Lbs.)</b>															
MiTek USP Stock No.	Ref. No.	Ga.	Dimensions (in)				Min Stem Wall (in)	Fastener Schedule <sup>1,12</sup>		Allowable Tension Loads (Lbs.) <sup>6,7</sup>				Code Ref.	
			W	L	I <sub>E</sub>	D		CS	Qty <sup>8</sup>	Type	Uncracked		Cracked		
											Corner <sup>3</sup>	Middle <sup>4,5</sup>	Corner <sup>3</sup>		Middle <sup>4,5</sup>
LSTAD8	LSTHD8	14	3	21-5/8	8	5	4-5/8	6	16	16d Sinker	1995	3125	1595	2735	--
LSTAD8RJ	LSTHD8RJ			35-1/8											
STAD8	--	12	3	21-5/8	8	5	4-5/8	6	16	16d Sinker	1985	2945	1665	2780	IBC, FL, LA
STAD8RJ	--			35-1/8											
STAD10	STHD10	12	3	21-5/8	10	5	1-5/8	6	22	16d Sinker	2740	4275	2220	3920	
STAD10RJ	STHD10RJ			36											
STAD14	STHD14	12	3	32-1/8	14	5	4-5/8	6	22	16d Sinker	3880	4185	3880	4185	
STAD14RJ	STHD14RJ			39-5/8											

- 1) Pre-drilled holes are not required.
- 2) Wood thickness shall be no less than 3" (2 - 2x members).
- 3) Corner strap location implies that the distance from the corner of the wall to the edge of the strap is no less than 1/2".
- 4) Middle strap location implies that the minimum distance from the corner of the wall to the centerline of the strap is no less than 1.5 times the embedment depth.
- 5) For edge distances between 1/2" and 1.5 x I<sub>E</sub> calculate loads using straight line interpolation.
- 6) Minimum anchor spacing for full capacity is 2 x I<sub>E</sub>. For spacing less than that reduce capacity proportionally.
- 7) Allowable tension loads are for Doug-Fir, Southern Pine, Spruce-Pine-Fir and Hem Fir.
- 8) The strap should be fastened with nails starting from lowest pair of nail holes and working up towards the top of the strap. In many cases, not all nail holes are needed to be filled.
- 9) Minimum concrete strength f'c = 2,500 psi.
- 10) Minimum 1-#4 rebar shall be installed in the shear cone.
- 11) Deflection at highest allowable loads for installation over wood double studs are as follows:  
LSTAD8 = 0.037", STAD8 = 0.048", STAD10 = 0.059", STAD14 = 0.122".
- 12) **NAILS:** 16d sinkers are 0.148" dia. x 3-1/4" long. 10d common (0.148" dia. x 3" long) nails may be substituted with no load reduction.



Foundation Straps offer an economical, one-piece method of achieving a continuous load path from a 2 x 8, 2 x 10, 2 x 12, or 2 x 14 rim joist through concrete block to foundation. All models require a 6" embedment into concrete footings.

**Materials:** 12 gauge

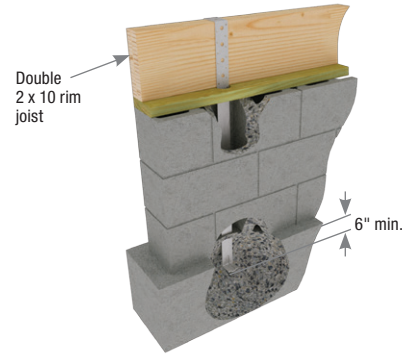
**Finish:** G90 galvanizing

**Options:** See chart for Corrosion Finish Options

**Codes:** See page 12 for Code Reference Chart

**Installation:**

- Use all specified fasteners. See Product Notes, page 20.
- Allowable loads are based on either nail fastening or bolt fastening; nail and bolt values cannot be combined.
- Install by inserting product into footing's wet concrete. All models require a 6" embedment into concrete foundations. Courses of concrete block must be laid over connector. Notch mudsill at connector locations. Wrap strap over rim joist and fasten.
- Do not rely on these straps to secure concrete sections together between cold joints; take other measures to transfer the load. If there is a cold joint between block and foundation, the minimum embedment must be made into the foundation.
- Based on product embedment the exposed number of fastener holes may be reduced. Using fewer fasteners will reduce allowable loads. Reduce allowable loads by the code prescribed allowable load per fastener, for each fastener not installed.
- Allowable loads are based on a minimum concrete compressive strength of 2,500 psi at 28 days.



**Typical TA stud to foundation installation**



**TA**

Holdowns

MiTek USP Stock No.	Ref. No.	Dimensions (in)			DF/SP Allowable Loads (Lbs.)												Corrosion Finish	Code Ref.
		W	L	L1	2 x 8			2 x 10			2 x 12			2 x 14				
					Fastener Schedule <sup>1,4</sup>		Uplift <sup>2</sup>	Fastener Schedule <sup>1,4</sup>		Uplift <sup>2</sup>	Fastener Schedule <sup>1,4</sup>		Uplift <sup>2</sup>	Fastener Schedule <sup>1,4</sup>		Uplift <sup>2</sup>		
					Qty	Type	160%	Qty	Type	160%	Qty	Type	160%	Qty	Type	160%		
TA51	PA51	2-1/16	48-1/4	17-5/8	2	1/2	1340	3	1/2	1950	4	1/2	2475	5	1/2	3230	--	
					8	16d x 2-1/2	1905	10	16d x 2-1/2	2385	14	16d x 2-1/2	3230	16	16d x 2-1/2	3230		
TA71	PA68	2-1/16	68-1/4	22-1/8	2	1/2	1340	3	1/2	1950	4	1/2	2475	5	1/2	3230		
					8	16d x 2-1/2	1905	10	16d x 2-1/2	2385	14	16d x 2-1/2	3230	16	16d x 2-1/2	3230		

- 1) Bolt values are for 3" thick rim joist loaded perpendicular to grain.
- 2) Uplift loads have been increased 60% for wind and seismic loads; no further increase shall be permitted.
- 3) Minimum of (9) 16d nails per strap is required to meet IRC R 404.1.5.
- 4) **NAILS:** 16d x 2-1/2 nails are 0.162" dia. x 2-1/2" long.

**Corrosion Finish**

- Stainless Steel
- Gold Coat
- HDG
- Triple Zinc

**HPA series** – For installation into poured concrete walls, foundations, or masonry. The HPA is the heavy-duty version of the PA anchor.

**PA series** – For installation into poured concrete or concrete block walls and foundations.

**PAI series** – For wood I-Joist applications. An expanded 3" on-center nail spacing reduces splitting along I-Joist flange.

**Materials:** HPA – 10 gauge; PA / PAI – 12 gauge

**Finish:** G90 galvanizing

**Options:** See chart for Corrosion Finish Options

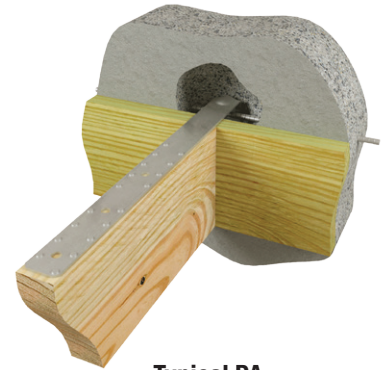
**Codes:** See page 12 for Code Reference Chart  
IBC 1620.2.1

**Installation:**

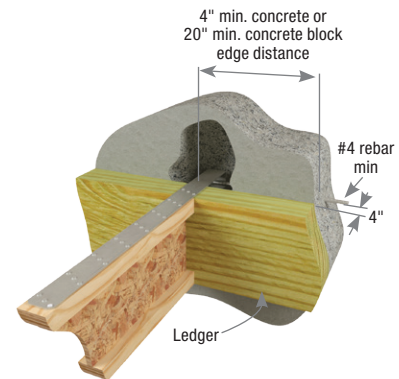
- Use all specified fasteners. See Product Notes, page 20.
- Minimum concrete strength is 2,500 psi.
- The allowable loads for bolts are based on parallel to grain loading with a 3" minimum member thickness, except the HPA which requires a 3-1/2" thick wood member. Reduce load per code requirements when minimum member thickness is not achieved.
- Minimum concrete edge distance is 4" for PA & PAI series, and 6" for HPA series.
- Minimum concrete block edge distance is 20".
- Designer may specify alternate fastening schedules. Refer to Nail Specification Table on page 23 for nail shear values. Load values shall not exceed published allowable loads.
- No anchor bolts are needed for achieving efficient stress transfer from framing to concrete walls or foundations.



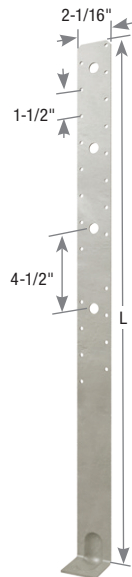
**Typical PA holdown installation**



**Typical PA purlin installation**



**Typical PAI I-Joist purlin face installation**



**PA / HPA**



**PAI**

MiTek USP Stock No.	Ref. No.	L (in)	Minimum Embedment		Nailer Size	Fastener Schedule <sup>5</sup>				DF/SP Allowable Tension Loads (Lbs.) <sup>1,3</sup>				Corrosion Finish	Code Ref.
			Concrete	Masonry		Min Qty <sup>6</sup>		Concrete		Masonry					
						Nails <sup>4,7</sup>	Bolts	Nails	Bolts <sup>2</sup>	Nails	Bolts <sup>2</sup>				
			Qty	Nail		Qty	Dia.	160%	160%	160%	160%				
PA18	PA18	18-1/2	4	6	Max Capacity	12	16d	2	1/2	3035	2260	3035	2260		
					2x & 3x Ledger										
					4x Ledger										
PA23	PA23	23-3/4	4	6	Max Capacity	15	16d	3	1/2	3700	3265	3035	3035		
					2x & 3x Ledger										
					4x Ledger										
PA28	PA28	29	4	6	Max Capacity	15	16d	4	1/2	3700	3700	3035	3035		
					2x & 3x Ledger										
					4x Ledger										
PA35	PA35	35	4	6	Max Capacity	15	16d	4	1/2	3700	3700	3035	3035		
					2x & 3x Ledger										
					4x Ledger										
HPA28	HPA28	29	6	8	Max Capacity	23	16d	4	1/2	5055	4280	3035	3035		
					2x & 3x Ledger										
					4x Ledger										
HPA35	HPA35	35	6	8	Max Capacity	23	16d	4	1/2	5425	4280	3035	3035		
					2x & 3x Ledger										
					4x Ledger										
PAI18	PAI18	18-1/2	4	6	Max Capacity	12	10d x 1-1/2	--	--	2475	--	2475	--		
					2x & 3x Ledger					2475		1855			
					4x Ledger					2270		1855			
PAI23	PAI23	23-1/2	4	6	Max Capacity	18	10d x 1-1/2	--	--	3700	--	3035	--		
					2x & 3x Ledger					3510					
					4x Ledger					3095					
PAI28	PAI28	28-1/2	4	6	Max Capacity	24	10d x 1-1/2	--	--	3700	--	3035	--		
					2x & 3x Ledger										
					4x Ledger										
PAI35	PAI35	35-1/2	4	6	Max Capacity	26	10d x 1-1/2	--	--	3700	--	3035	--		
					2x & 3x Ledger										
					4x Ledger										

- 1) Allowable Loads have been increased 60% for wind or seismic loads; no further increase shall be permitted.
- 2) The allowable loads for bolts are based on parallel-to-grain loading with 3" minimum member thickness, except HPA which requires a 3-1/2" thick wood member.
- 3) Allowable loads are based on the use of either nails or bolts; nail and bolt values cannot be combined.
- 4) 16d sinkers or 10d common nails may be substituted for the specified 16d common nails at 0.85 of the table loads.
- 5) For alternate nail schedule and load values consult MiTek.
- 6) Minimum quantity of fasteners to be installed. Product may have additional fastener holes not needed to meet published allowable load of product.
- 7) **NAILS:** 10d x 1-1/2 nails are 0.148" dia. x 1-1/2" long, 16d nails are 0.162" dia. x 3-1/2" long.

**Corrosion Finish** ■ Stainless Steel ■ Gold Coat ■ HDG ■ Triple Zinc

# TDL Concrete Angles



These angles secure wood posts to concrete or wood floors in light-duty applications.

**Materials:** 12 gauge

**Finish:** G90 galvanizing

**Options:** See Chart for Corrosion Finish Options.

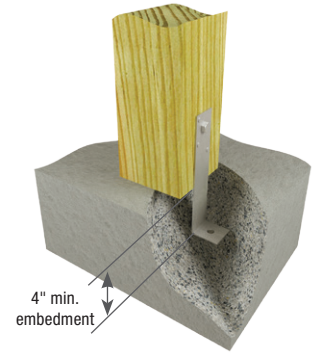
**Codes:** See page 12 for Code Reference Chart

**Installation:**

- Use all specified fasteners. See Product Notes, page 20.
- The TDL10 can be embedded into concrete. Minimum embedment depth is 4" to achieve allowable loads.
- **Moisture barrier may be required.**



**Typical TDL5 interior installation**



**Typical TDL10 embedded interior installation**

Holdowns

MiTek USP Stock No.	Ref. No.	Steel Gauge	Dimensions (in)			Fastener Schedule <sup>4,5</sup>						DF/SP Allowable Loads (Lbs.) <sup>1,2,3</sup>		Corrosion Finish	Code Ref.
			W	H	D	Anchor Bolts		Strap				Uplift 160%			
						Qty	Dia. (in)	Nails		Bolts		Nails	Bolts		
								Qty	Type	Qty	Dia. (in)				
TDL5	A24	12	2	5-3/16	2-1/4	1	1/2	4	16d	1	1/2	955	1105	Green	--
TDL10	A311	12	2	9-3/4	2-1/4	1	1/2	4	16d	1	1/2				



**TDL10**

- 1) Allowable loads are based on the use of either nails or bolts; nail and bolt values cannot be combined.
- 2) The bolt values are based on single shear with a minimum member thickness of 3-1/2".
- 3) Allowable loads have been increased in accordance with the code; no further increase shall be permitted.
- 4) Designer must specify anchor bolt type, length, and embedment.
- 5) **NAILS:** 16d nails are 0.162" dia. x 3-1/2" long.

**Corrosion Finish** ■ Stainless Steel ■ Gold Coat ■ HDG ■ Triple Zinc

RPB-TZ post base attaches 4x4 or larger wood post to concrete or wood surfaces and the key feature is the ability for installation after the post is in place. Can be installed with 1 or 2 RPB-TZ's (single or double). Post may also be installed on our CPB composite post base product which provides a 1" stand off as required in untreated wood installations. Installs with concrete screws, so no more mis-installed, mis-located, anchor bolts!

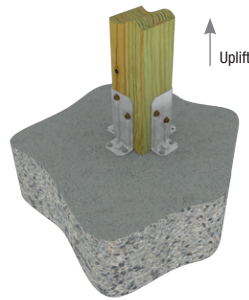
**Materials:** 12 gauge

**Finish:** G-185 galvanizing

**Codes:** See page 12 for Code Reference Chart

**Installation:**

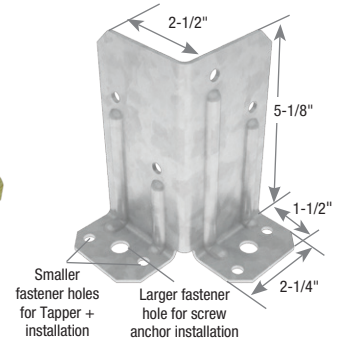
- USP's WS-EXT wood screws and screw anchors are not included with RPB bases.
- **Not recommended for fence posts or other unrestrained (not fixed or fastened at top) applications. These anchors are not designed to resist overturning (moment) loads.**
- **Concrete Installation:**
  1. Place RPB-TZ over one corner of post flush to both concrete and post surfaces and mark hole locations in concrete. Place aside.
  2. Drill holes for concrete screws using appropriate bit and hammer drill.
  3. Place RPB-TZ in position and install with specified screw anchors as listed in table below.
  4. Repeat for RPB-TZ on other side of post for double installations.
- **Wood-to-Wood Installation:**
  1. Place RPB-TZ over one corner of post flush to wood base and post surfaces.
  2. Install all specified WS-EXT wood screws as listed in the table below.
  3. Repeat for RPB-TZ on other side of post for double installations.



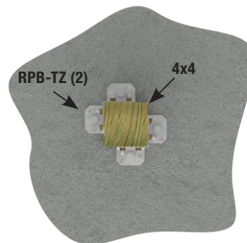
**Typical double RPB-TZ concrete installation**



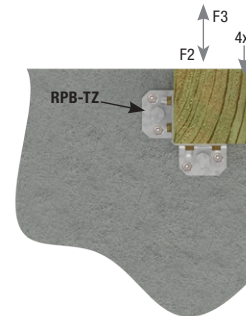
**Typical double RPB-TZ wood-to-wood installation**



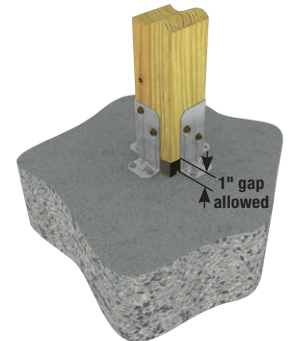
**RPB-TZ**



**Typical double RPB-TZ concrete installation Min 2-1/2" from any concrete edge**  
(Top view)



**Typical single RPB-TZ installation at concrete corner, flush to edge**  
(Top view)



**Typical double RPB-TZ installation with CPB composite post base**  
(CPB ordered separately)

Caps & Bases

Copyright © 2019 MiTek Industries, Inc. All Rights Reserved

MiTek USP Stock No.	Ref. No.	Steel Gauge	Qty of RPB's	Fastener Schedule <sup>4</sup>		DF/SP Allowable Loads (Lbs.) <sup>1,4,5</sup>			Corrosion Finish	Code Ref.		
				Post		Base		Uplift 160%			F2 160%	F3 160%
				Qty	Wood Screw	Qty	Screw Anchor <sup>2,3</sup>					
RPB-TZ	RPBZ	12	<b>Concrete Base with Post Flush to Corner<sup>6</sup></b>									
			1	4	WS3-EXT	2	3/8" x 2-1/2"	1525	710	495		
						4	Tapper+	735	655			
			1	4	WS15-EXT	2	3/8" x 2-1/2"	1470	710	495		
						4	Tapper+	735	655			
			<b>Concrete Base with Post 2-1/2" from Concrete Edge<sup>6</sup></b>									
			1	4	WS15-EXT or WS3-EXT	2	3/8" x 2-1/2"	1470 <sup>9</sup>	710	495		
						4	Tapper+	865	655			
			2 <sup>5</sup>	8	WS15-EXT or WS3-EXT	4	3/8" x 2-1/2"	2295	990	990		
						8	Tapper+	1735				
<b>LVL Base/SP Base<sup>7,8</sup></b>												
1	4	WS15-EXT or WS3-EXT	4	WS15-EXT	1110	960	495					
2	8	WS15-EXT or WS3-EXT	8		2220							

- Corrosion Finish**
- Stainless Steel
  - Gold Coat
  - HDG
  - Triple Zinc

1) Allowable loads are for DF/SP 4x4, 6x6, or larger posts. For SPF/HF loads, multiply the allowable load by 0.86.  
 2) Use DeWalt 3/8" x 2-1/2" Screw-Bolt+ screw anchor; or equal, installed in accordance with manufacturer's specification. Screw anchors are not supplied, see page 46 for anchor information.  
 3) Use Powers 1/4" x 1-3/4" Tapper+ concrete screw anchor (not supplied); or equal, installed in accordance with manufacturer's specification.  
 4) When installing connectors in pairs, the post must be a minimum of 2-1/2" from the edge of the concrete.  
 5) Allowable loads have been increased 60% for wind and seismic loads; no further increase shall be permitted.  
 6) Concrete compressive strength shall be 2,500 psi or greater at 28 days.  
 7) LVL framing base shall be at least 1-3/4" thick.  
 8) SYP framing base shall be at least 1-1/2" thick.  
 9) Allowable uplift for single RPB-TZ using WS3-EXT wood screws with Screw-Bolt+ screw anchors for concrete base with post 2-1/2" from concrete edge is 1,525 lbs.  
 New products or updated product information are designated in blue font.

Post Anchors are used to secure wood posts to concrete footings. These post anchors also provide moisture damage protection and feature a 1" stand-off plate to elevate wood posts above concrete surfaces as required by building code.

**PAE** – 2-sided post anchors with high uplift and bearing capacity.

**PA** – High capacity utilizing 4-sided design.

**PAU** – Higher uplift resistance and optional bolt fastening to post.

**Materials:** See chart

**Finish:** G90 galvanizing, PA66ER-TZ - G-185 galvanizing

**Options:** See chart for Corrosion Finish Options

**Codes:** See page 12 for Code Reference Chart

IRC R317.1.4, IBC 2304.11.2.7,

IRC R407.3, IBC 2304.9.7.

**Installation:**

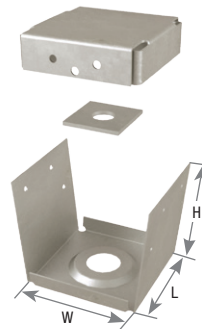
- Use all specified fasteners. Install with supplied washer. See Product Notes, page 20.
- Anchor bolts and nails are not furnished.
- **Not recommended for fence posts or other unrestrained (not fixed or fastened at top) applications. These anchors are not designed to resist overturning (moment) loads.**
- **Anchor bolt installation** – place specified diameter anchor bolt at desired location with minimum 4" embedment into minimum 2,500 psi concrete. A minimum 2" edge distance from the outermost edge of the post base to the edge of the concrete is required to achieve allowable loads.
- **For cured concrete or retrofit installations** – use specified diameter threaded rod with MiTek's CIA-EA or CIA-GEL 7000-C adhesive epoxy, following installation instructions. Contact MiTek Engineering for further information on selecting the proper epoxy.



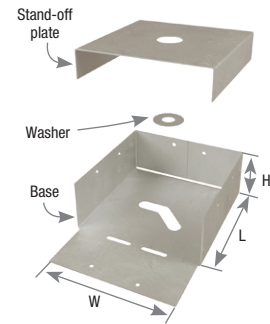
**Typical PA44E installation**



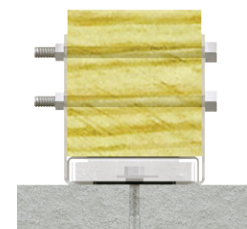
**Typical PA installation**



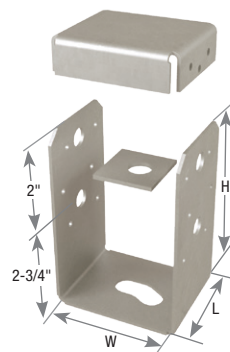
**PAE**



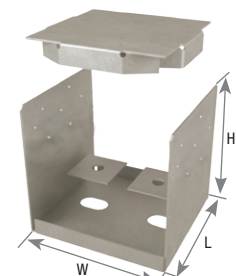
**PA**



**PAU cross-section**



**PAU**



**PAU88**

AVAILABLE IN  
**GOLD  
COAT**

Post/ Column Size	MiTek USP Stock No.	Ref. No.	Steel Gauge		Dimensions (in)			Fastener Schedule <sup>2,4</sup>						DF/SP Allowable Loads (Lbs.) <sup>3</sup>			Corrosion Finish	Code Ref.
			Base	Stand- off Plate	W	H	L	Anchor Bolt		Post				Bearing 100%	Uplift <sup>1</sup>			
								Qty	Dia. (in)	Nails		Bolts			Nails 160%	Bolts 160%		
										Qty	Type	Qty	Dia. (in)					
4 x 4	PA44	--	18	12	3-9/16	2-1/4	3-1/2	1	1/2	8	16d	--	--	4155	455	--	IBC, FL, LA	
	PA44E	ABA44	18	16	3-9/16	3-1/2	3-1/2	1	1/2	6	16d	--	--	6775	1035	--		
	PAU44	ABU44	12	16	3-9/16	5-7/16	3	1	5/8	12	16d	2	1/2	6775	2535	2265		
4 x 4 Rough	PA44R	--	18	12	4-1/16	2-1/2	4	1	1/2	12	16d	--	--	4155	455	--		
4 x 6	PA46	--	18	12	3-9/16	2-1/4	5-1/2	1	1/2	14	16d	--	--	4155	455	--	IBC, FL	
	PA46E	ABA46	18	12	3-9/16	3-1/2	5-1/2	1	5/8	8	16d	--	--	<b>6775</b>	<b>1035</b>	--		
	PAU46	ABU46	10	12	3-9/16	6	5	1	5/8	12	16d	2	1/2	13815	2535	2265		
4 x 6 Rough	PA46R	--	18	10	4-1/16	3-1/2	6	1	1/2	14	16d	--	--	4155	455	--	IBC, FL, LA	
5 x 5 Rough	PA55R-TZ	--	16	12	5	3-5/8	5	1	1/2	8	16d HDG	--	--	4155	455	--	--	
6 x 6	PA66	--	18	12	5-1/2	2-7/8	5-1/2	1	1/2	16	16d	--	--	5930	250	--	IBC, FL, LA	
	PA66E	ABA66	14	12	5-1/2	3-1/2	5-1/2	1	5/8	8	16d	--	--	16005	1130	--		
	PAU66	ABU66	10	12	5-1/2	6	5	1	5/8	12	16d	2	1/2	16005	<b>2425</b>	2265		
6 x 6 Rough	PA66R	--	18	12	6-1/16	3-1/4	6-1/16	1	1/2	16	16d	--	--	5930	250	--	IBC, FL	
	PA66ER-TZ	ABA66R	14	12	6	3-1/4	5-1/2	1	5/8	8	16d HDG	--	--	16005	<b>1130</b>	--		
	PAU66R-TZ	ABU66RZ	10	12	6-1/16	5-3/4	5	1	5/8	12	16d HDG	<b>2</b>	<b>1/2</b>	16005	1475	<b>1475</b>		
8 x 8	PAU88	ABU88	12	12	7-1/2	7-3/16	7-1/16	2	5/8	14	16d	--	--	<b>24895</b>	<b>3315</b>	--	IBC, FL, LA	
8 x 8 Rough	PAU88R	ABU88R	12	12	8-1/16	6-15/16	7-1/16	2	5/8	14	16d	--	--	<b>24895</b>	<b>3315</b>	--	IBC, FL, LA	
10 x 10	PAU1010	ABU1010	12	16	9-1/2	7-3/16	9-1/2	2	5/8	14	16d	<b>2</b>	<b>5/8</b>	27095	1495	<b>1495</b>	IBC, FL	
10 x 10 Rough	PAU1010R	--	12	16	10-1/16	7-3/16	10	2	5/8	14	16d	<b>2</b>	<b>5/8</b>	27095	1495	<b>1495</b>		
12 x 12	PAU1212	ABU1212	12	16	11-1/2	6-7/8	11-1/2	2	5/8	18	16d	<b>2</b>	<b>5/8</b>	64015	1180	<b>1180</b>		
12 x 12 Rough	PAU1212R	--	12	16	12-1/8	6-7/8	12-1/8	2	5/8	18	16d	<b>2</b>	<b>5/8</b>	64015	1180	<b>1180</b>		

Caps & Bases

Copyright © 2019 MiTek Industries, Inc. All Rights Reserved

- 1) Uplift loads have been increased 60% for wind or seismic loads; no further increase shall be permitted.
- 2) All bolts shall meet or exceed the specifications of ASTM A 307.
- 3) Allowable loads are based on the use of either nails or bolts; nail and bolt values cannot be combined.
- 4) **NAILS:** 16d nails are 0.162" dia. x 3-1/2" long.  
New products or updated product information are designated in **blue font**.

**Corrosion Finish** ■ Stainless Steel ■ Gold Coat ■ HDG ■ Triple Zinc

**WAS** – A formed base providing a 1" stand-off with high bearing capacity.

**WE** – A formed, one-piece design. Includes embossing for additional lateral strength.

**Materials:** See chart

**Finish:** G90 galvanizing

**Options:** See chart for Corrosion Finish Options

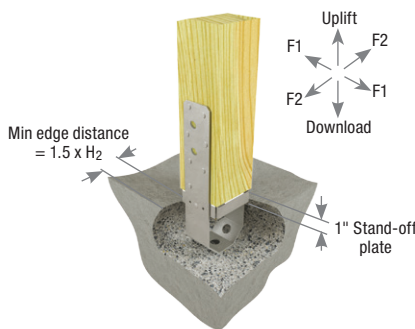
**Codes:** See page 12 for Code Reference Chart

IRC R317.1.4, IBC 2304.11.2.7,

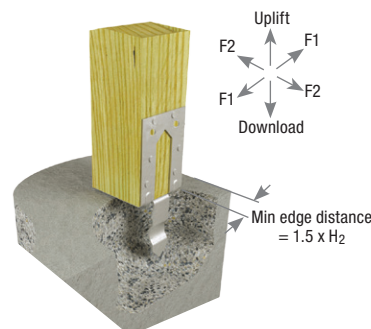
IRC R407.3, IBC 2304.9.7.

**Installation:**

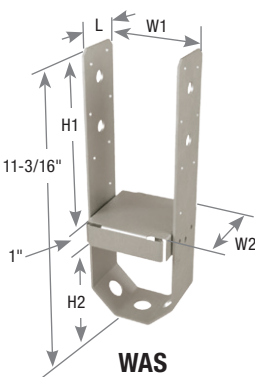
- Use all specified fasteners. See Product Notes, page 20.
- Insert into wet concrete after the pour. For the **WE**, embed the anchor so that the base plate is flush with the surface of the concrete. For the **WAS**, embed the anchor until the concrete surface meets the bottom edge of the stand off base legs. This will provide a 1" stand-off where required.
- **Not recommended for fence posts or other unrestrained (not fixed or fastened at top) applications. These anchors are not designed to resist overturning (moment) loads.**



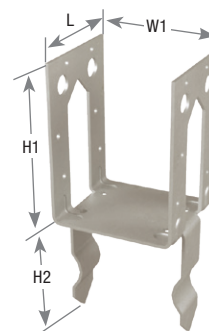
**Typical WAS installation**



**Typical WE installation**



**WAS**



**WE**

Caps & Bases

Post Size	MiTek USP Stock No.	Ref. No.	Steel Gauge		Dimensions (in)					Fastener Schedule <sup>5,6</sup>		DF/SP Allowable Loads (Lbs.) <sup>2,4</sup>						Corrosion Finish	Code Ref.
			Base	Strap	W1	W2	H1	H2 <sup>3</sup>	L	Qty	Type	Uncracked Concrete			Cracked Concrete				
												Download 100%	Uplift <sup>1</sup> 160%	F1 160%	F2 160%	Uplift <sup>1</sup> 160%	F1 160%		
<b>SDC A &amp; B</b>																			
4 x 4	WE44	PB44	12	12	3-1/2	--	4-3/4	3-3/8	3-1/4	12	16d	15335	1405	860	970	1245	600	680	IBC, FL, LA
	WAS44	PBS44A	16	14	3-9/16	3-1/2	6-3/4	3-1/2	2-1/4	14	16d	6775	3090	1365	1095	2165	955	770	
4 x 4 Rough	WE44R	PB44R	12	12	4	--	5	3-5/8	3-3/8	12	16d	15335	1405	860	970	1245	600	680	
4 x 6	WE46	PB46	12	12	5-1/2	--	4-3/4	3-3/8	3-1/4	12	16d	24130	1405	860	970	1245	600	680	IBC, FL, LA
	WAS46	PBS46	12	14	3-9/16	5-1/2	6-3/4	3-1/2	2-1/4	14	16d	13815	3090	1365	1095	2165	955	770	
4 x 6 Rough	WE46R	--	12	12	6	--	5	3-5/8	3-3/8	12	16d	24130	1405	860	970	1245	600	680	
6 x 6	WE66	PB66	12	12	5-1/2	--	5	3-5/8	5-3/8	12	16d	29565	1405	860	970	1245	600	680	IBC, FL, LA
	WAS66	PBS66	12	12	5-1/2	5-1/2	6-3/4	5	2-1/4	14	16d	16005	3365	1955	1685	2505	1370	1685	
6 x 6 Rough	WE66R	PB66R	12	12	6	--	5	3-5/8	5-3/8	12	16d	29565	1405	860	970	1245	600	680	
<b>SDC C-F</b>																			
4 x 4	WE44	PB44	12	12	3-1/2	--	4-3/4	3-3/8	3-1/4	12	16d	15335	1255	755	850	1090	525	595	IBC, FL, LA
	WAS44	PBS44A	16	14	3-9/16	3-1/2	6-3/4	3-1/2	2-1/4	14	16d	6775	2705	1195	960	1895	835	675	
4 x 4 Rough	WE44R	PB44R	12	12	4	--	5	3-5/8	3-3/8	12	16d	15335	1255	755	850	1090	525	595	
4 x 6	WE46	PB46	12	12	5-1/2	--	4-3/4	3-3/8	3-1/4	12	16d	24130	1255	755	850	1090	525	595	IBC, FL, LA
	WAS46	PBS46	12	14	3-9/16	5-1/2	6-3/4	3-1/2	2-1/4	14	16d	13815	2705	1195	960	1895	835	675	
4 x 6 Rough	WE46R	--	12	12	6	--	5	3-5/8	3-3/8	12	16d	24130	1255	755	850	1090	525	595	
6 x 6	WE66	PB66	12	12	5-1/2	--	5	3-5/8	5-3/8	12	16d	29565	1255	755	850	1090	525	595	IBC, FL, LA
	WAS66	PBS66	12	12	5-1/2	5-1/2	6-3/4	5	2-1/4	14	16d	16005	3135	1715	1685	2195	1200	1665	
6 x 6 Rough	WE66R	PB66R	12	12	6	--	5	3-5/8	5-3/8	12	16d	29565	1255	755	850	1090	525	595	

1) Uplift loads have been increased 60% for wind or seismic loads; no further increase shall be permitted.  
 2) Allowable loads are based on the use of either nails or bolts; nail and bolt values cannot be combined.  
 3) H2 is minimum embedment length of anchor into concrete.  
 4) Minimum concrete strength f'c = 2,500 psi.  
 5) All bolts shall meet or exceed the specifications of ASTM A 307.  
 6) **NAILS:** 16d nails are 0.162" dia. x 3-1/2" long.

**Corrosion Finish**

- Stainless Steel
- Gold Coat
- HDG
- Triple Zinc



The EPB44T-TZ Elevated Post Base is an economical solution for supporting 4x4 posts at the minimum 1 inch above the concrete foundation as required by the building code. For applications where uplift loads are not present, the EPB44T-TZ can be installed directly into a hole predrilled in a pier block or concrete foundation as shown in Figure A below. To resist uplift loading, the EPB44T-TZ must be cast into concrete or epoxied into place as shown in Figure B below.

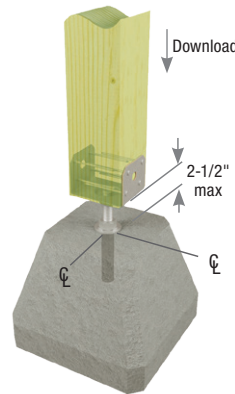
**Materials:** 12 gauge

**Finish:** G-185 galvanizing U-bracket; Hot-dip galvanized threaded rod, nuts, washers

**Codes:** See page 12 for Code Reference Chart

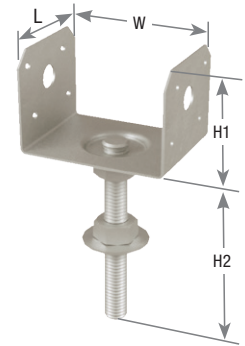
**Installation:**

- Use all specified fasteners. See Product Notes, page 20.
- **Drilled Hole – No Uplift Resistance**
  - Drill 5/8" diameter hole into cured concrete 4" deep.
  - Insert threaded rod of EPB44T-TZ into hole and adjust nut to desired height.
  - Install 4x4 post and fasten with (8) 10d common nails.
- **Embedded In Concrete – Uplift Resistance Installation**
  - Adjust nut for desired height.
  - Insert threaded rod with nut and washer into wet concrete.
  - Provide temporary support to post base (if needed) to maintain vertical and horizontal position.
  - After concrete has cured, install 4x4 post and fasten with (8) 10d common nails.
- **Epoxied Into Place – Uplift Resistance Installation**
  - Drill 3/4" diameter hole into cured concrete 4" deep.
  - Clean hole as per MiTek's recommendations.
  - Adjust nut for desired height.
  - Fill the hole 3/4 full with MiTek Epoxy. Visit MiTek-US.com for proper installation procedures and injection of MiTek epoxy products.
  - Insert threaded rod with nut and washer into hole, pressing down until the washer is firmly seated on the concrete.
  - After epoxy has cured, install 4x4 post and fasten with (8) 10d common nails.
- **Not recommended for fence posts or other unrestrained (not fixed or fastened at top) applications. These anchors are not designed to resist overturning (moment) loads.**

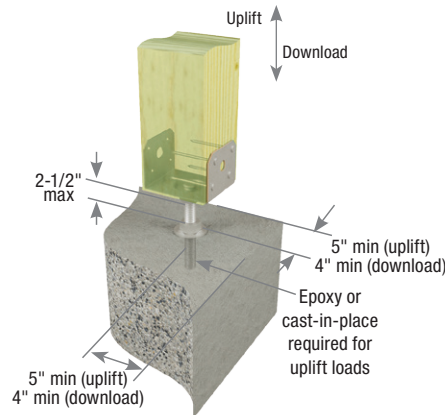


**Figure A**

**Typical EPB44T-TZ pier block installation**



**EPB44T-TZ**



**Figure B**

**Typical EPB44T-TZ installation with MiTek's Epoxy**

Post Size	MiTek USP Stock No.	Ref. No.	Steel Gauge (U-bracket)	Dimensions (in)				Wood Post Size	Fastener Schedule <sup>8</sup>		Installation Type <sup>6,7</sup>	DF/SP Allowable Loads (Lbs.) <sup>1,5</sup>			Corrosion Finish	Code Ref.
				W	L	H1	H2		Qty	Type		Uncracked Concrete <sup>5</sup>	Cracked & Uncracked Concrete <sup>5</sup>			
													SDC A & B	SDC A & B		
												Uplift 160% <sup>2,3</sup>		Download 100% <sup>4</sup>		
4x4	EPB44T-TZ	--	12	3-9/16	2-7/8	2-7/16	4-7/8	4x4	8	10d	Pier Block	--	5525	5525	IBC, FL, LA	
											Embedded	790	5525	5525		
											Epoxy	790	5525	5525		

1) Allowable loads are based on a maximum distance of 2-1/2" between the concrete foundation and the bottom of the post base.  
 2) Uplift loads have been increased 60% for wind and seismic loads; no further increase shall be permitted.  
 3) Uplift capacity requires the post base to be cast-in-place or epoxy post-installed in a concrete member capable of resisting the upward force.  
 4) Download is based on the bearing of the wood in the post base and the bearing of the washer on the concrete.  
 5) Minimum concrete strength f'c = 2,500 psi.  
 6) Pier Block installation, drill a 5/8" diameter hole a minimum of 4" deep.  
 7) Epoxy installation, drill a 3/4" diameter hole a minimum of 4" deep. Follow published epoxy installation instructions available at MiTek-US.com.  
 8) **NAILS:** 10d nails are 0.148" dia. x 3" long.

**Corrosion Finish** ■ Stainless Steel ■ Gold Coat ■ HDG ■ Triple Zinc

# EBG / EPB / EPBH Elevated Post Bases



These post bases allow installers to pre-align posts and preset post heights above concrete floors or footings. By eliminating post-to-concrete contact, moisture damage is reduced. Elevated post bases are ideal for building carports, decks or porches. All series feature convenient nail fastening to post.

**Materials:** See chart

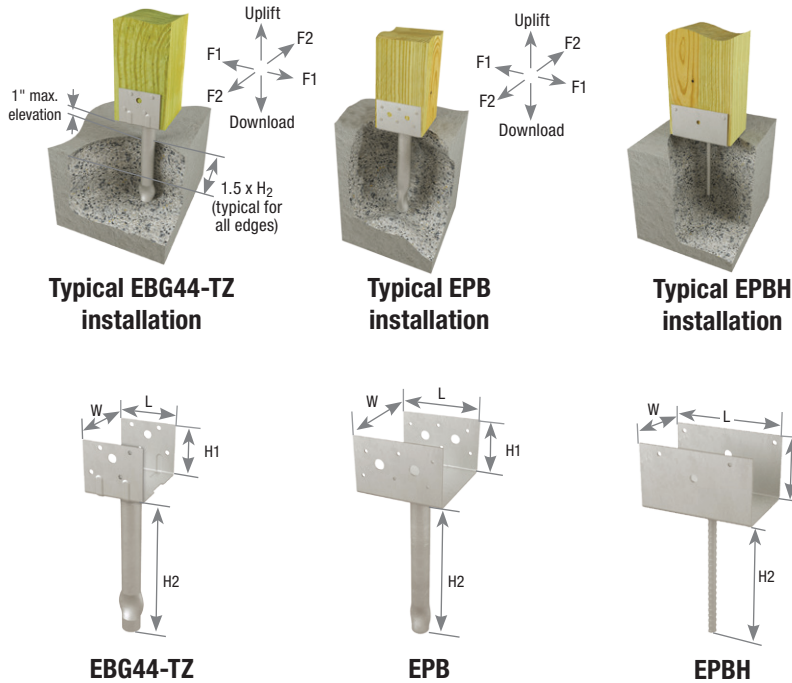
**Finish:** EPB – Primer;  
EBG44-TZ – G-185 galvanizing;  
EPBH – Hot-dip galvanized

**Options:** See chart for Corrosion Finish Options

**Codes:** See page 12 for Code Reference Chart  
IRC R317.1.4, IBC 2304.11.2.7, IRC R407.3, IBC 2304.9.7.

**Installation:**

- Use all specified fasteners. See Product Notes, page 20.
- **Not recommended for fence post or other fixed post applications. These anchors are not designed to resist overturning (moment) loads.**



Caps & Bases

Post Size	MiTek USP Stock No.	Ref. No.	Steel Gauge		Dimensions (in)				Fastener Schedule <sup>4</sup>		DF/SP Allowable Loads (Lbs.) <sup>3</sup>						Corrosion Finish	Code Ref.
			Base	Tube	W	L	H1	H2	Qty	Nail	Uncracked Concrete			Cracked Concrete				
											Download 100%	Uplift <sup>2</sup> 160%	F1 <sup>1</sup> 160%	F2 <sup>1</sup> 160%	Uplift <sup>2</sup> 160%	F1 <sup>1</sup> 160%		
<b>SDC A &amp; B</b>																		
4 x 4	EBG44-TZ	EPB44A	14	16	3-9/16	2-3/4	2-3/8	7-1/2	8	16d HDG	4615	1085	1440	1295	800	1010	905	IBC, FL, LA
	EPB4408	EPB44, EPB44-12	12	--	3-9/16	3	3	8	8	16d	3045	1110	1440	1295	775	1010	905	LA
	EPBH44	--	12	--	3-1/2	3-3/8	2-3/4	7	4	16d HDG	2485	990	990	975	990	845	845	--
4 x 6	EPB4608	EPB46, EPB46-12	12	--	3-9/16	5	3	8	12	16d	3045	1110	1440	1295	775	1010	905	IBC, FL, LA
4 x 6 Rough	EPBH46R	--	12	--	4-1/8	5-3/8	3	7	4	16d HDG	4615	990	990	975	990	845	845	--
6 x 6	EPB6608	EPB66, EPB66-12	12	--	5-9/16	5	3-3/16	8	12	16d	4665	1110	1440	1295	775	1010	905	IBC, FL, LA
	EPBH66	--	12	--	5-1/2	5-3/8	3	7	4	16d HDG	4615	990	990	975	990	845	845	--
6 x 6 Rough	EPBH66R	--	12	--	6-1/8	5-3/8	3	7	4	16d HDG	4615	990	990	975	990	845	845	--
<b>SDC C-F</b>																		
4 x 4	EBG44-TZ	EPB44A	14	16	3-9/16	2-3/4	2-3/8	7-1/2	8	16d HDG	4615	1000	1260	1135	700	885	795	IBC, FL, LA
	EPB4408	EPB44, EPB44-12	12	--	3-9/16	3	3	8	8	16d	3045	970	1260	1135	680	885	795	LA
	EPBH44	--	12	--	3-1/2	3-3/8	2-3/4	7	4	16d HDG	2485	990	990	975	990	725	725	--
4 x 6	EPB4608	EPB46, EPB46-12	12	--	3-9/16	5	3	8	12	16d	3045	970	1260	1135	680	885	795	IBC, FL, LA
4 x 6 Rough	EPBH46R	--	12	--	4-1/8	5-3/8	3	7	4	16d HDG	4615	990	990	975	990	725	725	--
6 x 6	EPB6608	EPB66, EPB66-12	12	--	5-9/16	5	3-3/16	8	12	16d	4665	970	1260	1135	680	885	795	IBC, FL, LA
	EPBH66	--	12	--	5-1/2	5-3/8	3	7	4	16d HDG	4615	990	990	975	990	725	725	--
6 x 6 Rough	EPBH66R	--	12	--	6-1/8	5-3/8	3	7	4	16d HDG	4615	990	990	975	990	725	725	--

1) Lateral loads (F1 and F2) are for conditions where pipe extends no more than 1" above the concrete surface.  
 2) Uplift Loads have been increased 60% for wind and seismic loads; no further increase shall be permitted.  
 3) Concrete compressive strength shall be 2,500 psi or greater at 28 days.  
 4) **NAILS:** 16d nails are 0.162" dia. x 3-1/2" long.

**Corrosion Finish**  
■ Stainless Steel ■ Gold Coat  
■ HDG ■ Triple Zinc

Copyright © 2019 MiTek Industries, Inc. All Rights Reserved

High capacity column base fastens to column with WS wood screws.

**Materials:** 10 gauge

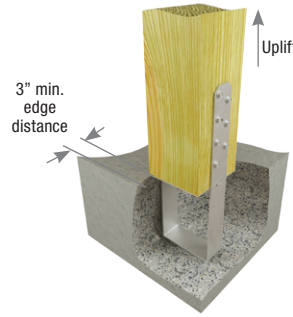
**Finish:** G90 galvanizing

**Options:** KCBQ models available in rough/full sizes  
See chart for Corrosion Finish Options

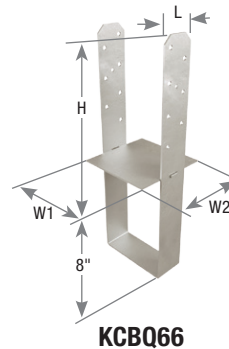
**Codes:** See page 12 for Code Reference Chart  
IRC R407.3, IBC 2304.9.7.

**Installation:**

- Use all specified fasteners. See Product Notes, page 20.
- WS2 Wood Screws, 1/4" dia. x 2" long, are supplied with KCBQ Column Bases.
- **Not recommended for fence posts or other unrestrained (not fixed or fastened at top) applications. These bases are not designed to resist overturning (moment) loads.**
- All models require a minimum edge distance of 3".
- Embed column base with bottom of base plate flush to concrete.



Typical KCBQ66 installation



Column Size	MiTek USP Stock No.	Ref. No.	Steel Gauge	Dimensions (in)				Fastener Schedule <sup>2</sup>		DF/SP Allowable Loads (Lbs.) <sup>3</sup>				Corrosion Finish	Code Ref.
				W1	W2 <sup>4</sup>	H	L	Qty	Type	Uncracked Concrete		Cracked Concrete			
										Uplift 160% <sup>1</sup>		Uplift 160% <sup>1</sup>			
				SDC A & B	SDC C-F	SDC A & B	SDC C-F								
4 x 4	KCBQ44	--	10	3-9/16	3-1/2	8-3/4	2-1/4	14	WS2	6870	6530	5330	4570		
4 x 6	KCBQ46	--	10	3-9/16	5-1/2	8-3/4	2-1/4	14	WS2	6870	6530	5330	4570		
4 x 8	KCBQ48	--	10	3-9/16	7-1/2	8-3/4	2-1/4	14	WS2	6870	6530	5330	4570		
6 x 4	KCBQ64	--	10	5-1/2	3-1/2	8-3/4	2-1/4	14	WS2	6870	6530	5330	4570		
6 x 6	KCBQ66	--	10	5-1/2	5-1/2	8-3/4	2-1/4	14	WS2	6870	6530	5330	4570		
6 x 8	KCBQ68	--	10	5-1/2	7-1/2	8-3/4	2-1/4	14	WS2	6870	6530	5330	4570		
7-1/8 x 3-1/2	KCBQ71-4	--	10	7-1/8	3-1/2	8-3/4	2-1/4	14	WS2	6870	6530	5330	4570		
7-1/8 x 5-1/2	KCBQ71-6	--	10	7-1/8	5-1/2	8-3/4	2-1/4	14	WS2	6870	6530	5330	4570		--
7-1/8 x 7-1/8	KCBQ71-7	--	10	7-1/8	7-1/8	8-3/4	2-1/4	14	WS2	6870	6530	5330	4570		
8 x 6	KCBQ86	--	10	7-1/2	5-1/2	8-3/4	2-1/4	14	WS2	6870	6530	5330	4570		
8 x 8	KCBQ88	--	10	7-1/2	7-1/2	8-3/4	2-1/4	14	WS2	6870	6530	5330	4570		
10 x 10	KCBQ1010	--	10	9-1/2	9-1/2	8-3/4	2-1/4	14	WS2	6870	6530	5330	4570		
10 x 12	KCBQ1012	--	10	9-1/2	11-1/2	8-3/4	2-1/4	14	WS2	6870	6530	5330	4570		
12 x 12	KCBQ1212	--	10	11-1/2	11-1/2	8-3/4	2-1/4	14	WS2	6870	6530	5330	4570		
Glulam Sizes															
5-1/8 glulam	KCBQ5	--	10	5-1/4	Specify	8-3/4	2	14	WS2	6870	6530	5330	4570		
6-3/4 glulam	KCBQ7	--	10	6-7/8	Specify	8-3/4	2	14	WS2	6870	6530	5330	4570		--
8-3/4 glulam	KCBQ9	--	10	8-7/8	Specify	8-3/4	2	14	WS2	6870	6530	5330	4570		

1) Uplift loads have been increased 60% for wind or seismic loads; no further increase shall be permitted.  
 2) WS2 Wood Screws are 1/4" dia. x 2" long and are included with KCBQ Column Bases.  
 3) Concrete compressive strength shall be 2,500 psi or greater at 28 days.  
 4) "Specify" denotes the required width that must be specified at the time of ordering.

**Corrosion Finish** ■ Stainless Steel ■ Gold Coat ■ HDG ■ Triple Zinc

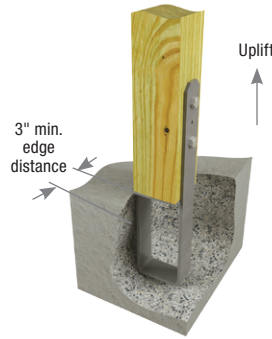
Provides high structural capacity and installs with bolts providing an architectural appearance.

**Materials:** See chart

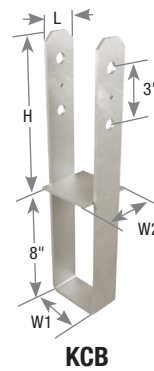
**Finish:** KCB (5/8" bolt models) – G90 galvanizing;  
KCB (3/4" bolt models) – Primer

**Options:** KCB models available in rough/full size.  
See chart for Corrosion Finish Options

**Codes:** See page 12 for Code Reference Chart  
IRC R407.3, IBC 2304.9.7



Typical KCB installation



**Installation:**

- Use all specified fasteners. See Product Notes, page 20.
- **Not recommended for fence posts or other unrestrained (not fixed or fastened at top) applications. These bases are not designed to resist overturning (moment) loads.**
- All models require a minimum edge distance of 3".
- Bolted models feature diamond holes for temporary nail fastening to facilitate drilling and bolting.
- Embed column base with bottom of base plate flush to concrete.

Column Size	MiTek USP Stock No.	Ref. No.	Steel Gauge		Dimensions (in)				Fastener Schedule <sup>2</sup>		DF/SP Allowable Loads (Lbs.) <sup>3</sup>				Corrosion Finish	Code Ref.
			Strap	Base	W1	W2	H	L	Bolts		Uncracked Concrete		Cracked Concrete			
									Qty	Type	Uplift 160% <sup>1</sup>		Uplift 160% <sup>1</sup>			
4 x 4	KCB44	CB44	7	7	3-9/16	3-9/16	8-7/8	2	2	5/8	5525	5100	4165	3570		
4 x 6	KCB46	CB46	7	7	3-9/16	5-1/2	8-7/8	2	2	5/8	5525	5100	4165	3570		
4 x 8	KCB48	CB48	7	7	3-9/16	7-1/2	8-7/8	2	2	5/8	5525	5100	4165	3570		
6 x 4	KCB64	CB64	7	7	5-1/2	3-1/2	8-7/8	3	2	5/8	6700	6465	5280	4525		
6 x 6	KCB66	CB66	7	7	5-1/2	5-1/2	8-7/8	3	2	5/8	6700	6465	5280	4525		
6 x 8	KCB68	CB68	7	7	5-1/2	7-1/2	8-7/8	3	2	5/8	6700	6465	5280	4525		
6 x 10	KCB610	CB610	7	7	5-1/2	9-1/2	8-7/8	3	2	5/8	6700	6465	5280	4525		
7 x 3-1/2	KCB74	CB7-1/8-4	3	7	7-1/8	3-1/2	9-3/4	3	2	3/4	6700	6465	5280	4525		--
7 x 5-1/2	KCB76	CB7-1/8-6	3	7	7-1/8	5-1/2	9-3/4	3	2	3/4	6700	6465	5280	4525		
7 x 7	KCB77	CB7-1/8-7	3	7	7-1/8	7-1/8	9-3/4	3	2	3/4	6700	6465	5280	4525		
8 x 6	KCB86	CB86	3	7	7-1/2	5-1/2	9-3/4	3	2	3/4	6700	6465	5280	4525		
8 x 8	KCB88	CB88	3	7	7-1/2	7-1/2	9-3/4	3	2	3/4	6700	6465	5280	4525		
10 x 10	KCB1010	CB1010	3	7	9-1/2	9-1/2	9-3/4	3	2	3/4	6700	6465	5280	4525		
10 x 12	KCB1012	CB1012	3	7	9-1/2	11-1/2	9-3/4	3	2	3/4	6700	6465	5280	4525		
12 x 12	KCB1212	CB1212	3	7	11-1/2	11-1/2	9-3/4	3	2	3/4	6700	6465	5280	4525		
<b>Glulam Sizes</b>																
5-1/8 glulam	KCB5	CB5-4.5, CB5-6	3	7	5-1/4	specify	9-3/4	3	2	3/4	6700	6465	5280	4525		
6-3/4 glulam	KCB7	CB7-6, CB7-7.5, CB7-9, CB7-10.5	3	7	6-7/8	specify	9-3/4	3	2	3/4	6700	6465	5280	4525		--
8-3/4 glulam	KCB9	CB9-6, CB9-7.5, CB9-9, CB9-10.5	3	7	8-7/8	specify	9-3/4	3	2	3/4	6700	6465	5280	4525		

1) Uplift Loads have been increased 60% for wind and seismic loads, no further increase shall be permitted.  
2) All bolts shall meet or exceed the specifications of ASTM A 307.  
3) Concrete compressive strength shall be 2,500 psi or greater at 28 days.

**Corrosion Finish** ■ Stainless Steel ■ Gold Coat ■ HDG ■ Triple Zinc

12 gauge base for carports, patios, or other residential framing.

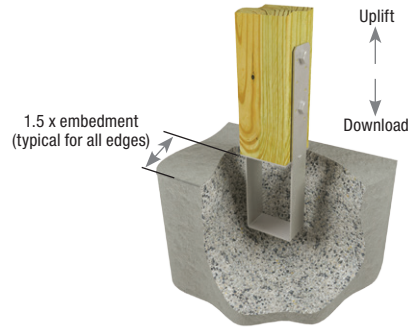
**Materials:** 12 gauge

**Finish:** G90 galvanizing

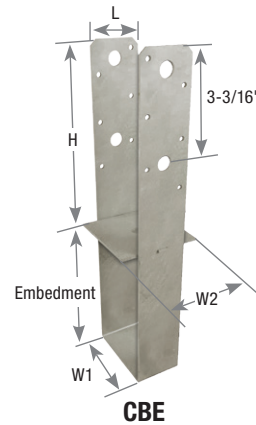
**Codes:** See page 12 for Code Reference Chart  
IRC R407.3, IBC 2304.9.7

**Installation:**

- Use all specified fasteners. See Product Notes, page 20.
- **Not recommended for fence posts or other unrestrained (not fixed or fastened at top) applications. These bases are not designed to resist overturning (moment) loads.**
- Bolted models feature diamond holes for temporary nail fastening to facilitate drilling and bolting.
- Embed column base with bottom of base plate flush to concrete.



**Typical CBE installation**



**CBE**

Column Size	MiTek USP Stock No.	Ref. No.	Steel Gauge	Dimensions (in)					Fastener Schedule <sup>2,6</sup>		DF/SP Allowable Loads (Lbs.) <sup>3,4</sup>				Code Ref.	
				W1	W2	H	L	Embedment <sup>5</sup>	Qty	Type	Download 100%	Uncracked Concrete		Cracked Concrete		
												Uplift 160% <sup>1</sup>		Uplift 160% <sup>1</sup>		
		SDC A & B		SDC C-F		SDC A & B		SDC C-F								
4 x 4	CBE44	--	12	3-9/16	3-1/2	7-1/2	2	6-1/2	12	16d	16835	2975	2975	2975	2770	
									2	1/2		4090	3605	3160		
4 x 6	CBE46	--	12	3-9/16	5-1/2	7-1/2	2	6-1/2	12	16d	26450	2975	2975	2975	2770	
									2	1/2		4090	3605	3160		
6 x 6	CBE66	--	12	5-1/2	5-1/2	7-1/2	2	5-1/2	12	16d	30250	2975	2975	2975	2770	
									2	1/2		4090	3605	3160		

1) Uplift Loads have been increased 60% for wind and seismic loads, no further increase shall be permitted.  
 2) All bolts shall meet or exceed the specifications of ASTM A 307.  
 3) Concrete compressive strength shall be 2,500 psi or greater at 28 days.  
 4) Allowable loads are based on the use of either nails or bolts; nail and bolt values cannot be combined.  
 5) CBE column base shall be embedded into concrete up to this depth.  
 6) **NAILS:** 16d nails are 0.162" dia. x 3-1/2" long.

These column bases install using MiTek's WS2-EXT Wood Screws, reducing installation time and cost. Designed for high uplift in high wind or seismic applications. Includes a stand-off plate to protect the wood from ground contact moisture as required by building code.

**Materials:** See chart

**Finish:** G-185 galvanizing

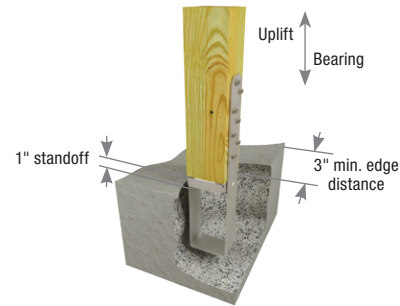
**Options:** See chart for Corrosion Finish Options

**Codes:** See page 12 for Code Reference Chart

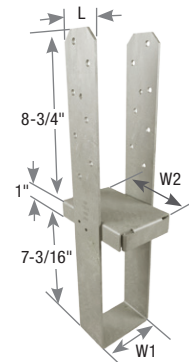
IRC R317.1.4, IBC 2304.11.2.7, IRC R407.3, IBC 2304.9.7

**Installation:**

- Use all specified fasteners. See Product Notes, page 20.
- WS2-EXT Wood Screws, 1/4" dia. x 2" long, are supplied with CBSQ Bases.
- Maintain 3" minimum edge distance between post and edge of concrete.
- Embed the column base until the concrete surface meets the bottom edge of the stand-off plate.
- **Not recommended for fence posts or other unrestrained (not fixed or fastened at top) applications. These bases are not designed to resist overturning (moment) loads.**



Typical CBSQ44-TZ installation



CBSQ46-TZ

Column Size	MiTek USP Stock No.	Ref. No.	Steel Gauge		Dimensions (in)				Fastener Schedule <sup>2</sup>	Wood Screws	DF/SP Allowable Loads (Lbs.) <sup>3</sup>				Corrosion Finish	Code Ref.
			Strap	Base	W1	W2	L	Embed <sup>4</sup>			Uncracked Concrete		Cracked Concrete			
											Download 100%	Uplift 160% <sup>1</sup>	Download 100%	Uplift 160% <sup>1</sup>		
<b>SDC A &amp; B</b>																
4 x 4	CBSQ44-TZ	CBSQ44-SDS2	10	16	3-9/16	3-1/2	2-1/4	7-3/16	14	WS2-EXT	11950	5955	11950	4165		
4 x 6	CBSQ46-TZ	CBSQ46-SDS2	10	12	3-9/16	5-7/16	2-1/4	7-3/16	14	WS2-EXT	11955	5955	11955	4165		--
6 x 6	CBSQ66-TZ	CBSQ66-SDS2	10	12	5-1/2	5-7/16	3	7-3/16	14	WS2-EXT	11955	6870	11955	5280		
<b>SDC C-F</b>																
4 x 4	CBSQ44-TZ	CBSQ44-SDS2	10	16	3-9/16	3-1/2	2-1/4	7-3/16	14	WS2-EXT	11950	5100	11950	3570		
4 x 6	CBSQ46-TZ	CBSQ46-SDS2	10	12	3-9/16	5-7/16	2-1/4	7-3/16	14	WS2-EXT	11955	5100	11955	3570		--
6 x 6	CBSQ66-TZ	CBSQ66-SDS2	10	12	5-1/2	5-7/16	3	7-3/16	14	WS2-EXT	11955	6465	11955	4525		

1) Uplift Loads have been increased 60% for wind and seismic loads, no further increase shall be permitted.

2) WS2-EXT Wood Screws are 1/4" dia. x 2" long and are included with CBSQ Column Bases.

3) Concrete compressive strength shall be 2,500 psi or greater at 28 days.

4) The CBSQ shall be embedded into concrete up to specified depth. The minimum side cover is 3".

**Corrosion Finish** ■ Stainless Steel ■ Gold Coat ■ HDG ■ Triple Zinc

# D Post Anchors

Secures nominal sized posts to wood surfaces for light-duty applications.

**Materials:** 18 gauge

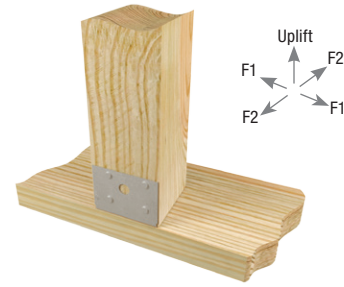
**Finish:** G90 galvanizing; D44-TZ & D46R-TZ - G-185 galvanizing

**Options:** See chart for Corrosion Finish Options

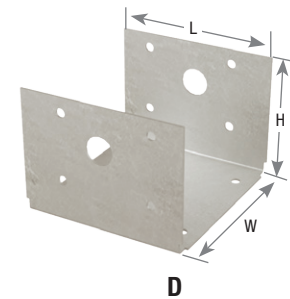
**Codes:** See page 12 for Code Reference Chart

**Installation:**

- Use all specified fasteners. See Product Notes, page 20.
- **Not recommended for fence posts or other unrestrained (not fixed or fastened at top) applications. These anchors are not designed to resist overturning (moment) loads.**
- While D series post anchors offer some lateral and uplift resistance, they are not recommended as a primary means of anchorage for posts in railings.



Typical D installation



Post Size	MiTek USP Stock No.	Ref. No.	Steel Gauge	Dimensions (in)			Fastener Schedule <sup>2</sup>				DF/SP Allowable Loads (Lbs.) <sup>1</sup>			S-P-F Allowable Loads (Lbs.) <sup>1</sup>			Corrosion Finish	Code Ref.
				W	H	L	Post		Beam		Uplift 160%	F1 160%	F2 160%	Uplift 160%	F1 160%	F2 160%		
							Qty	Type	Qty	Type								
4 x 4	D44-TZ	BC40, BC40Z	18	3-9/16	2-1/2	3-3/8	8	16d HDG	4	16d HDG	700	885	885	565	760	760	■	IBC, FL, LA
4 x 4 Rough	D44R	BC40R	18	4	3	3-3/4	8	16d	4	16d	700	885	885	565	760	760	■	
4 x 6	D46	BC460	18	3-9/16	3	5-3/8	10	16d	5	16d	700	995	1095	585	840	920	■	IBC, FL
4 x 6 Rough	D46R-TZ	--	18	4	3	5-3/8	10	16d	5	16d	700	995	1095	585	840	920	■	
6 x 6	D66	BC60	18	5-1/2	3	5-3/8	10	16d	5	16d	700	995	1095	585	840	920	■	IBC, FL, LA
6 x 6 Rough	D66R	BC60R	18	6	3	5-3/8	10	16d	5	16d	700	995	1095	585	840	920	■	
8 x 8	D88	BC80	18	7-1/2	3	7-3/8	12	16d	5	16d	700	995	1095	585	840	920	■	

1) Allowable loads have been increased 60% for wind or seismic loads; no further increase shall be permitted.

2) **NAILS:** 16d nails are 0.162" dia. x 3-1/2" long.

New products or updated product information are designated in **blue font**.

**Corrosion Finish** ■ Stainless Steel ■ Gold Coat ■ HDG ■ Triple Zinc

# EPCM / PCM Post Caps



**PCM** – Provides a positive connection for medium-duty, post-to-beam applications.

**EPCM** – End column caps.

**Materials:** See chart

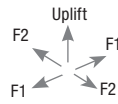
**Finish:** G90 galvanizing

**Options:** See chart for Corrosion Finish Options

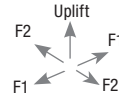
**Codes:** See page 12 for Code Reference Chart

**Installation:**

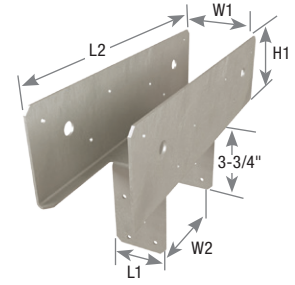
- Use all specified fasteners. See Product Notes, page 20.
- PCM 16 gauge post caps should not be substituted for PCM 12 gauge post caps unless approved by the Engineer of Record.



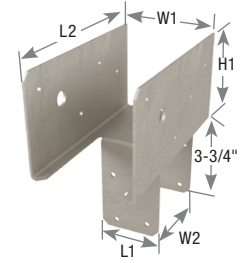
**Typical PCM46 center cap installation**



**Typical EPCM end cap installation**



**PCM**



**EPCM**

Caps & Bases

MiTek USP Stock No.	Ref. No.	Steel Gauge	Beam	Post	Dimensions (in)					Fastener Schedule <sup>2</sup>				DF/SP Allowable Loads (Lbs.)			Corrosion Finish	Code Ref.
					W1	W2	H1	L1	L2	Post		Beam		Uplift <sup>1</sup>	F1	F2		
										Qty	Type	Qty	Type					
<b>Center Column Caps</b>																		
PCM4416	PC44-16	16	4x	4x	3-9/16	3-9/16	3-9/16	2-7/16	11	8	16d	12	16d	970	1115	1335		
PCM44	PC44	12	4x	4x	3-9/16	3-9/16	3-9/16	2-7/16	11	8	16d	12	16d	1665	1350	1890		
PCM46	PC46	12	4x	6x	3-9/16	5-9/16	3-9/16	2-7/16	13	8	16d	12	16d	1665	1350	1890		
PCM4616	PC46-16	16	4x	6x	3-9/16	5-9/16	3-9/16	2-7/16	13	8	16d	12	16d	970	1115	1335		
PCM4816	PC48-16	16	4x	8x	3-9/16	7-9/16	3-9/16	2-7/16	15	8	16d	12	16d	970	1115	1335		
PCM48	PC48	12	4x	8x	3-9/16	7-9/16	3-9/16	2-7/16	15	8	16d	12	16d	1665	1350	1890		
PCM6416	PC64-16	16	6x	4x	5-1/2	3-9/16	3-1/2	3-13/16	11	8	16d	12	16d	950	1545	1675		
PCM64	PC64	12	6x	4x	5-1/2	3-9/16	3-1/2	3-13/16	11	8	16d	12	16d	1500	1875	1915		
PCM6616	PC66-16	16	6x	6x	5-1/2	5-9/16	3-1/2	3-13/16	13	8	16d	12	16d	950	1545	1675		
PCM66	PC66	12	6x	6x	5-1/2	5-9/16	3-1/2	3-13/16	13	8	16d	12	16d	1500	1875	1915		
PCM6816	--	16	6x	8x	5-1/2	7-9/16	3-1/2	3-13/16	15	8	16d	12	16d	950	1545	1675		
PCM68	PC68	12	6x	8x	5-1/2	7-9/16	3-1/2	3-13/16	15	8	16d	12	16d	1500	1875	1915		
PCM77	--	12	7-1/8	7-1/8	7-1/8	7-1/8	3-11/16	5-5/8	14-9/16	8	16d	12	16d	1500	1875	1915		
PCM8416	--	16	8x	4x	7-1/2	3-9/16	3-1/2	5-5/8	11	8	16d	12	16d	950	1545	1675		
PCM84	PC84	12	8x	4x	7-1/2	3-9/16	3-1/2	5-5/8	11	8	16d	12	16d	1500	1875	1915		
PCM8616	--	16	8x	6x	7-1/2	5-9/16	3-3/8	5-5/8	13	8	16d	12	16d	950	1545	1675		
PCM86	PC86	12	8x	6x	7-1/2	5-9/16	3-1/2	5-5/8	13	8	16d	12	16d	1500	1875	1915		
PCM8816	--	16	8x	8x	7-1/2	7-9/16	3-1/2	5-5/8	15	8	16d	12	16d	950	1545	1675		
PCM88	PC88	12	8x	8x	7-1/2	7-9/16	3-1/2	5-5/8	15	8	16d	12	16d	1500	1875	1915		
<b>End Column Caps</b>																		
EPCM4416	EPC44-16	16	4x	4x	3-9/16	3-9/16	3-9/16	2-7/16	7-1/4	8	16d	8	16d	970	1115	1335		
EPCM44	EPC44	12	4x	4x	3-9/16	3-9/16	3-9/16	2-7/16	7-1/4	8	16d	8	16d	1665	1350	1890		
EPCM46	EPC46	12	4x	6x	3-9/16	5-9/16	3-9/16	2-7/16	9-1/4	8	16d	8	16d	1665	1350	1890		
EPCM4616	EPC46-16	16	4x	6x	3-9/16	5-9/16	3-9/16	2-7/16	9-1/4	8	16d	8	16d	970	1115	1335		
EPCM4816	EPC48-16	16	4x	8x	3-9/16	7-9/16	3-9/16	2-7/16	11-1/4	8	16d	8	16d	970	1115	1335		
EPCM48	EPC48	12	4x	8x	3-9/16	7-9/16	3-9/16	2-7/16	11-1/4	8	16d	8	16d	1665	1350	1890		
EPCM6416	EPC64-16	16	6x	4x	5-1/2	3-9/16	3-1/2	3-13/16	7-1/4	8	16d	8	16d	950	1545	1675		
EPCM64	EPC64	12	6x	4x	5-1/2	3-9/16	3-1/2	3-13/16	7-1/4	8	16d	8	16d	1500	1875	1915		
EPCM6616	EPC66-16	16	6x	6x	5-1/2	5-9/16	3-1/2	3-13/16	9-1/4	8	16d	8	16d	950	1545	1675		
EPCM66	EPC66	12	6x	6x	5-1/2	5-9/16	3-1/2	3-13/16	9-1/4	8	16d	8	16d	1500	1875	1915		
EPCM6816	--	16	6x	8x	5-1/2	7-9/16	3-1/2	3-13/16	11-1/4	8	16d	8	16d	950	1545	1675		
EPCM68	EPC68	12	6x	8x	5-1/2	7-9/16	3-1/2	3-13/16	11-1/4	8	16d	8	16d	1500	1875	1915		
EPCM77	--	12	7-1/8	7-1/8	7-1/8	7-1/8	3-11/16	5-5/8	10-13/16	8	16d	8	16d	1500	1875	1915		
EPCM8416	--	16	8x	4x	7-1/2	3-9/16	3-1/2	5-5/8	7-1/4	8	16d	8	16d	950	1545	1675		
EPCM84	EPC84	12	8x	4x	7-1/2	3-9/16	3-1/2	5-5/8	7-1/4	8	16d	8	16d	1500	1875	1915		
EPCM8616	--	16	8x	6x	7-1/2	5-9/16	3-3/8	5-5/8	9-1/4	8	16d	8	16d	950	1545	1675		
EPCM86	EPC86	12	8x	6x	7-1/2	5-9/16	3-1/2	5-5/8	9-1/4	8	16d	8	16d	1500	1875	1915		
EPCM8816	--	16	8x	8x	7-1/2	7-9/16	3-1/2	5-5/8	11-1/4	8	16d	8	16d	950	1545	1675		
EPCM88	EPC88	12	8x	8x	7-1/2	7-9/16	3-1/2	5-5/8	11-1/4	8	16d	8	16d	1500	1875	1915		

- 1) Allowable loads have been increased 60% for wind or seismic loads; no further increase shall be permitted.
- 2) **NAILS:** 16d nails are 0.162" dia. x 3-1/2" long.

New products or updated product information are designated in **blue font**.

**Corrosion Finish**

- Stainless Steel
- Gold Coat
- HDG
- Triple Zinc

IBC, FL, LA



**BC** – One-piece design for double 2x's to a 4x post.

**BCS** – One-piece design connects 2-ply or 3-ply beams to the tops of 4x4 or 6x6 post. Slant nailing reduces the amount of nails required.

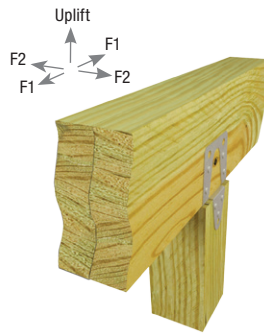
**C** – One-piece design.

**Materials:** 18 gauge

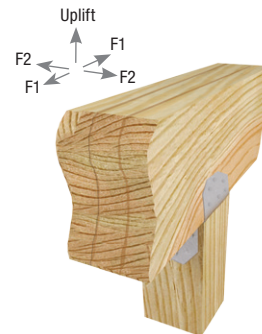
**Finish:** G90 galvanizing;  
BC400-TZ – G-185 galvanizing

**Options:** See chart for Corrosion Finish Options

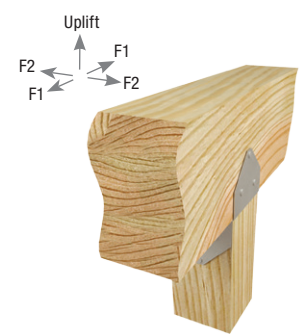
**Codes:** See page 12 for Code Reference Chart



**Typical BC400-TZ installation**



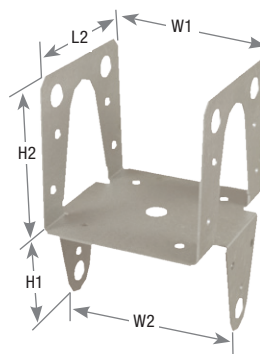
**Typical BCS23-6 installation**



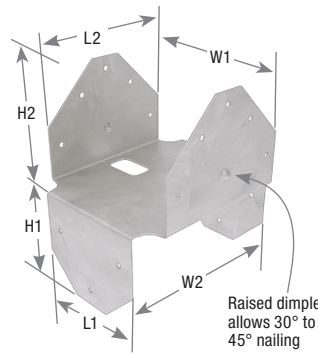
**Typical C44 installation**

**Installation:**

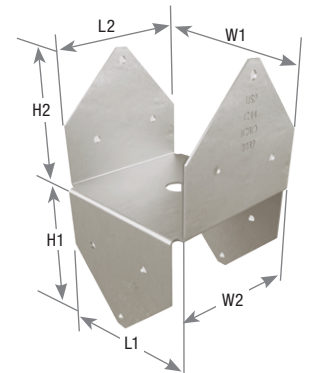
- Place post cap on top of post and fasten cap to post using specified nails.
- Place beam between top flanges of the cap and install all specified nails into beam.
- **BCS** – Slant nails must be installed through dimple holes at a 30° to 45° angle through the beam into the post to achieve listed loads. **Slant/double shear nails must be used to achieve listed load values.**



**BC400-TZ**



**BCS23-6**



**C44**

Caps & Bases

Post Size	MiTek USP Stock No.	Ref. No.	Steel Gauge	Dimensions (in)						Fastener Schedule <sup>2,3</sup>				DF/SP Allowable Loads (Lbs.) <sup>1</sup>			Corrosion Finish	Code Ref.
				W1	W2	H1	H2	L1	L2	Qty	Type	Qty	Type	Uplift 160%	F1 160%	F2 160%		
4 x 4	BCS22-4	BCS2-2/4	18	3-1/8	3-9/16	2-15/16	2-15/16	2-7/8	2-7/8	6	10d	8	10d	865	1065	--		
	BC400-TZ	--	18	3-1/8	3-9/16	2-3/8	3	3-1/2	3-5/16	10	10d x 1-1/2 HDG	8	10d x 1-1/2 HDG	615	780	580		--
	C44	BC4	18	3-9/16	3-9/16	2-7/8	2-7/8	3-1/4	3-1/4	6	16d	6	16d	<b>925</b>	<b>1110</b>	<b>1110</b>		
4 x 4 Rough	C44R	BC4R	18	4	4	2-5/8	2-5/8	3-1/4	3-1/4	8	16d	8	16d	<b>925</b>	<b>1110</b>	<b>1110</b>		IBC, FL, LA
4 x 6	C46	BC46	18	3-9/16	5-1/2	2-9/16	2-5/8	3-3/8	5-1/4	6	16d	10	16d	<b>925</b>	<b>1110</b>	<b>1110</b>		
4 x 6 Rough	C46R	--	18	4	6	2-3/4	2-3/4	3-1/4	5-1/4	8	16d	10	16d	<b>925</b>	<b>1110</b>	<b>1110</b>		
6 x 6	BCS23-6	BCS2-3/6	18	4-5/8	5-5/8	3	3-3/8	3-1/2	4-3/8	6	16d	12	16d	1120	1625	--		--
	C66	BC6	18	5-1/2	5-1/2	2-7/8	2-7/8	5-1/4	5-1/4	12	16d	12	16d	<b>1080</b>	<b>2045</b>	<b>2045</b>		
6 x 6 Rough	C66R	BC6R	18	6	6	2-13/16	2-13/16	5-1/4	5-1/4	<b>12</b>	16d	<b>12</b>	16d	<b>955</b>	<b>2210</b>	<b>2210</b>		IBC, FL, LA
8 x 8	C88	BC8	18	7-1/2	7-1/2	5	5	7-3/8	7-3/8	16	16d	16	16d	<b>1080</b>	<b>2260</b>	<b>2260</b>		

1) Allowable loads have been increased 60% for wind or seismic loads; no further increase shall be permitted.

2) BCS23-6: Substituting 16d x 2-1/2" nails for 16d common nails is not permitted for slant nailing.

3) **NAILS:** 10d x 1-1/2 nails are 0.148" dia. x 1-1/2" long, 10d nails are 0.148" dia. x 3" long, 16d nails are 0.162" dia. x 3-1/2" long. New products or updated product information are designated in **blue font**.

**Corrosion Finish**

- Stainless Steel
- Gold Coat
- HDG
- Triple Zinc

**PB** – Two-piece design.

**PBES / PBS** – Two-piece design with extended side plates and wrap around post design. Easy retrofit installations.

**Materials:** 18 gauge

**Finish:** G90 galvanizing; PB44-6TZ &

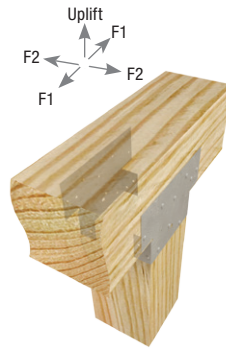
PB66-6TZ – G-185 galvanizing

**Options:** See chart for Corrosion Finish Options

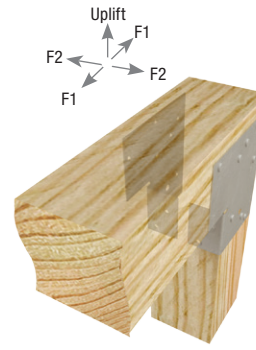
**Codes:** See page 12 for Code Reference Chart

**Installation:**

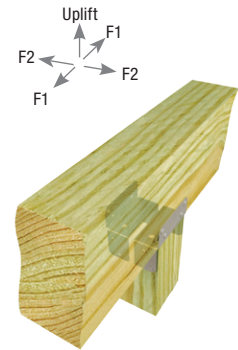
- Use all specified fasteners. See Product Notes, page 20.
- These products are designed for single, solid-sawn beams with matching post width. Multi-ply beams must have same width as post. Use shims as required.
- **PB, PBES, PBS post caps are sold per piece and are to be installed in pairs to achieve allowable loads.**



**Typical PBS installation**

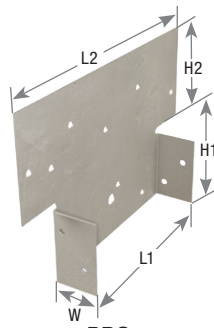


**Typical PBES installation**

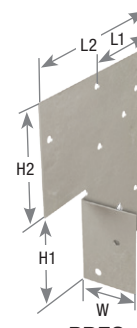


**Typical PB-TZ installation**

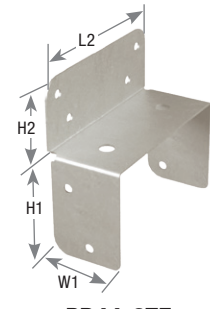
AVAILABLE IN  
**GOLD  
COAT**



**PBS**



**PBES**



**PB44-6TZ**

Post Size	MiTek USP Stock No.	Ref. No.	Steel Gauge	Dimensions (in)					Fastener Schedule <sup>2,3</sup>				DF/SP Allowable Loads (Lbs.) <sup>1,2</sup>			Corrosion Finish	Code Ref.
				W	H1	H2	L1	L2	Post		Beam		Uplift 160%	F1 160%	F2 160%		
									Qty	Type	Qty	Type					
4 x 4	PB44-6TZ	LPC4Z	18	1-1/2	2-1/8	1-1/2	--	3-5/8	8	16d HDG	8	16d HDG	595	1765	1030	IBC, FL, LA	
	PBES44	LCE4	18	1-1/2	2-3/8	2-3/4	3-1/4	4-3/4	8	16d	8	16d	1765	920	810		
	PBS44	AC4	18	1-7/16	2-5/16	2-13/16	3-9/16	6-1/2	12	16d	12	16d	2650	1860	1110		
4 x 4 Rough	PBS44R	AC4R	18	1-1/2	2-5/16	2-3/16	4	7	8	16d	8	16d	1765	920	810	IBC, FL, LA	
6 x 6	PB66-6TZ	LPC6Z	18	1-1/2	2-1/2	3	--	5-9/16	8	16d HDG	8	16d HDG	595	1765	1030		
	PBES66	--	18	1-1/2	2-3/8	2-1/8	5-1/2	7	8	16d	8	16d	1670	1190	1235		
	PBS66	AC6	18	1-1/4	2-5/16	2-7/8	5-1/2	8	14	16d	12	16d	2015	1865	1300		
6 x 6 Rough	PBS66R	AC6R	18	1-1/4	2-5/16	2-3/16	6	8-1/2	10	16d	10	16d	1670	1190	1235	IBC, FL, LA	

1) Allowable loads have been increased 60% for wind or seismic loads; no further increase shall be permitted.

2) Load and nail schedules for two-piece models are per pair of post caps.

3) **NAILS:** 16d nails are 0.162" dia. x 3-1/2" long.

New products or updated product information are designated in **blue font**.

**Corrosion Finish** ■ Stainless Steel ■ Gold Coat ■ HDG ■ Triple Zinc

The PBC series is a one-piece connector designed to secure two mitered beams on a corner post while providing uplift capacity.

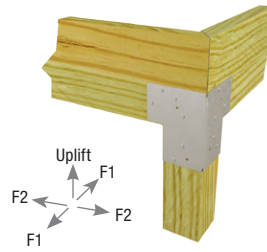
**Materials:** 18 gauge

**Finish:** G-185 galvanizing

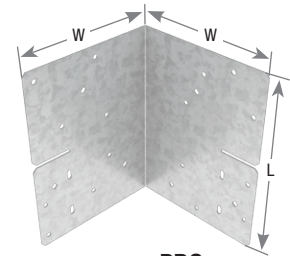
**Codes:** See page 12 for Code Reference Chart

**Installation:**

- Use all specified fasteners. See Product Notes, page 20.
- Install PBC on outside corner of post forming tabs to inner side of post.
- Assumes beam members are level cut at corner.



Typical PBC installation



PBC

Post Size	MiTek USP Stock No.	Ref. No.	Steel Gauge	Dimensions (in)		Fastener Schedule <sup>2</sup>				DF/SP Allowable Loads (Lbs.) <sup>1</sup>			S-P-F Allowable Loads (Lbs.) <sup>1</sup>			Corrosion Finish	Code Ref.
				W	L	Post		Beam		Uplift	F1	F2	Uplift	F1	F2		
						Qty	Type	Qty	Type								
4 x 4	PBC44-TZ	--	18	4-15/16	6-1/2	8	16d HDG	8	16d HDG	1765	1520	1520	1525	1275	1275	IBC, FL	
6 x 6	PBC66-TZ	--	18	6-15/16	6-1/2	8	16d HDG	8	16d HDG	1765	1520	1520	1525	1275	1275	FL	

1) Allowable loads have been increased 60% for wind or seismic loads; no further increase shall be permitted.

2) **NAILS:** 16d nails are 0.162" dia. x 3-1/2" long.

New products or updated product information are designated in **blue font**.

**Corrosion Finish** ■ Stainless Steel ■ Gold Coat ■ HDG ■ Triple Zinc

## CPB Composite Post Bases

The CPB is made of corrosion resistant composite material compatible with preservative treated lumber. Provides code required 1" stand-off and can be used with rough lumber sizes.

**Materials:** High Strength composite

**Codes:** See page 12 for Code Reference Chart.

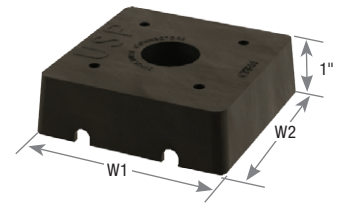
IRC R317.1.4, IBC 2304.11.2.7, IRC R407.3, IBC 2304.9.7

**Installation:**

- Attach base to post with (4) 10d HDG nails.
- Attach post to concrete using 1/2" diameter rod into concrete and extend into wood member.
- **Not recommended for fence posts or other unrestrained (not fixed or fastened at top) applications. These anchors are not designed to resist overturning (moment) loads.**



Typical CPB installation



CPB

Post Size	MiTek USP Stock No.	Ref. No.	Dimensions (in)		Bottom Surface Bearing Area	Fastener Schedule <sup>5</sup>		Post Base Allowable Capacity <sup>1,2</sup>	Concrete Design Bearing Strength <sup>3,4</sup>	Code Ref.
			W1	W2		Qty	Type			
4 x 4	CPB44	CPS4	3-1/4	3-1/4	2.2	4	10d HDG	5235	6545	PR
4 x 6	CPB46	CPS46	3-5/16	5-5/16	3.3	4	10d HDG	6810	9820	
5 x 5	CPB55	CPS5	4-1/8	4-1/8	3.0	4	10d HDG	6295	8925	
6 x 6	CPB66	CPS6	5-5/16	5-5/16	3.9	4	10d HDG	8570	11600	
8 x 8	CPB88	CPS7	7-1/4	7-1/4	6.4	4	10d HDG	12490	19040	

1) Loads shall not be increased for short-term loading.

2) Loads require a minimum 650 psi wood compressive strength.

3) Concrete Design Bearing Strength =  $\phi (0.85 f'_c A_1)$  with  $f'_c = 2,500$  psi. ACI 318-02, Section 10.17.1.

4) Design Bearing Strength has been increased assuming  $(A_2 / A_1)^{0.5}$  per ACI 318-02, Section 10.17.1.

5) **NAILS:** 10d nails are 0.148" dia. x 3" long.

# KLCC Lally Column Caps



Lally Column Caps connect lally columns to wood beams.  
Fits 3-1/2" and 4" diameter lally columns.

**Materials:** 12 gauge

**Finish:** Primer

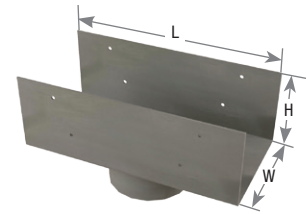
**Codes:** See page 12 for Code Reference Chart

**Installation:**

- Use all specified fasteners. See Product Notes, page 20.
- Fit KLCC onto lally column. Position wood beam in KLCC saddle and fasten.



Typical KLCC installation



KLCC

MiTek USP Stock No.	Ref. No.	Steel Gauge	Dimensions (in)			Fastener Schedule			Column Outside Dia. (in)	DF/SP Allowable Loads (Lbs.) <sup>1,2,3,4</sup>	S-P-F Allowable Loads (Lbs.) <sup>1,2,3,4</sup>	LVL / PSL Allowable Loads (Lbs.) <sup>1,2,3,4</sup>	Code Ref.
						Girder		Nails <sup>5</sup>					
			W	H	L	Qty	Qty	Type					
KLCC45-35	LCC4.5-3.5	12	4-5/8	4	11-1/2	Triple 2x10/12	8	16d	3-1/2	16000	16000	--	--
KLCC45-4	LCC4.5-4	12	4-5/8	4	11-1/2	Triple 2x10/12	8	16d	4	21000	21000	--	
KLCC6-35	LCC6-3.5	12	6-1/8	4	11-1/2	Quad 2x10/12	8	16d	3-1/2	16000	16000	--	
KLCC6-4	LCC6-4	12	6-1/8	4	11-1/2	Quad 2x10/12	8	16d	4	21000	21000	--	
KLCC35-35	LCC3.5-3.5	12	3-5/8	4	11-1/2	3.5 LVL / PSL	8	16d	3-1/2	--	--	16000	
KLCC35-4	LCC3.5-4	12	3-5/8	4	11-1/2	3.5 LVL / PSL	8	16d	4	--	--	21000	
KLCC525-35	LCC5.25-3.5	12	5-3/8	4	11-1/2	5.25 LVL / PSL	8	16d	3-1/2	--	--	16000	
KLCC525-4	LCC5.25-4	12	5-3/8	4	11-1/2	5.25 LVL / PSL	8	16d	4	--	--	21000	
KLCC7-35	LCC7-3.5	12	7-1/8	4	11-1/2	7 LVL / PSL	8	16d	3-1/2	--	--	16000	
KLCC7-4	LCC7-4	12	7-1/8	4	11-1/2	7 LVL / PSL	8	16d	4	--	--	21000	

- 1) Loads may not be increased for short-term loading.
- 2) Loads are for a continuous beam.
- 3) Allowable loads are determined using the lowest of the bearing loads. Use Fc equal to 335 psi for SPF, 625 psi for DF and 650 psi for LVL/PSL, or the lally column capacity.
- 4) Spliced conditions must be detailed by the designer to transfer tension loads between spliced members by means other than the lally column. The splice condition load is 6750 lbs. per beam side and the lally cap must be evenly loaded.
- 5) **NAILS:** 16d nails are 0.162" dia. x 3-1/2" long.

# KCCQ / KECCQ Column Caps

Designed to be installed without the need to drill bolt holes, simplifying installation and maintaining the wood cross section. Installs with WS Wood Screws offering high uplift capacity.

**KCCQ** – Standard column cap

**KECCQ** – End column version

**Materials:** See chart

**Finish:** Primer

**Options:** See chart for Corrosion Finish Options and Specialty Options on page 94.

**Codes:** See page 12 for Code Reference Chart

**Installation:**

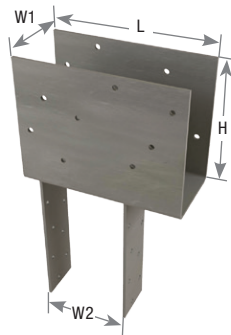
- Use all specified fasteners. See Product Notes, page 20.
- WS3 Wood Screws, 1/4" dia. x 3" long, are supplied with Column Caps.
- Beams shall be designed to support the required loads. Beam shear may limit loads to less than listed loads for device. A design professional shall determine the adequacy of the stud to resist published loads.



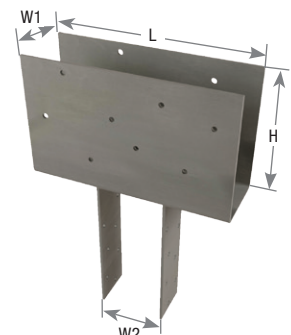
Typical KECCQ44 end cap installation



Typical KCCQ44 center cap installation



KECCQ44



KCCQ44

MiTek USP Stock No.	Ref. No.	Steel Gauge	Dimensions (in)				Fastener Schedule <sup>4</sup>				DF/SP Allowable Loads (Lbs.) <sup>3</sup>		Corrosion Finish	Code Ref.
			W1	W2	H	L	Beam		Column or Post		Bearing <sup>1</sup> 100%	Uplift <sup>2,8</sup> 160%		
							Qty	Type	Qty	Type				
<b>Center Column Caps</b>														
KCCQ325-4	CCQ3-4SDS2.5	7	3-1/4	3-5/8	6-1/2	11	16	WS3	14	WS3	21485	<b>7180</b>		
KCCQ325-6	CCQ3-6SDS2.5	7	3-1/4	5-1/2	6-1/2	11	16	WS3	14	WS3	21485	<b>7180</b>		
KCCQ44	CCQ44SDS2.5	7	3-5/8	3-5/8	6-1/2	11	16	WS3	14	WS3	24065	<b>7180</b>		
KCCQ45	--	7	3-5/8	5-3/8	6-1/2	11	16	WS3	14	WS3	24065	<b>7180</b>		
KCCQ46	CCQ46SDS2.5	7	3-5/8	5-1/2	6-1/2	11	16	WS3	14	WS3	24065	<b>7180</b>		
KCCQ47	--	7	3-5/8	7-1/8	6-1/2	11	16	WS3	14	WS3	24065	<b>7180</b>		
KCCQ47X	--	7	3-5/8	7-1/8	6-1/2	13	16	WS3	14	WS3	28440	<b>7180</b>		
KCCQ48	CCQ48SDS2.5	7	3-5/8	7-1/2	6-1/2	11	16	WS3	14	WS3	24065	<b>7180</b>		
KCCQ525-4	CCQ5-4SDS2.5	3	5-1/4	3-5/8	8	13	16	WS3	14	WS3	41640	<b>7180</b>		
KCCQ525-6	CCQ5-6SDS2.5	3	5-1/4	5-1/2	8	13	16	WS3	14	WS3	41640	<b>7180</b>		
KCCQ525-8	CCQ5-8SDS2.5	3	5-1/4	7-1/2	8	13	16	WS3	14	WS3	41640	<b>7180</b>		
KCCQ57	--	7	5-3/8	7-1/8	6-1/2	11	16	WS3	14	WS3	36095	<b>7180</b>		
KCCQ64	CCQ64SDS2.5	7	5-1/2	3-5/8	6-1/2	11	16	WS3	14	WS3	37815	<b>7180</b>		
KCCQ66	CCQ66SDS2.5	7	5-1/2	5-1/2	6-1/2	11	16	WS3	14	WS3	37815	<b>7180</b>		
KCCQ67X	CCQ6-7.13SDS2.5	7	5-1/2	7-1/8	6-1/2	11	16	WS3	14	WS3	37815	<b>7180</b>		
KCCQ68	CCQ68SDS2.5	7	5-1/2	7-1/2	6-1/2	11	16	WS3	14	WS3	37815	<b>7180</b>		
KCCQ74	CCQ74SDS2.5	3	6-7/8	3-5/8	6-1/2	11	16	WS3	14	WS3	46405	<b>7180</b>		
KCCQ76	CCQ76SDS2.5	3	6-7/8	5-1/2	6-1/2	11	16	WS3	14	WS3	46405	<b>7180</b>		
KCCQ77	CCQ77SDS2.5	3	6-7/8	6-7/8	6-1/2	11	16	WS3	14	WS3	46405	<b>7180</b>		
KCCQ78	CCQ78SDS2.5	3	6-7/8	7-1/2	6-1/2	11	16	WS3	14	WS3	46405	<b>7180</b>		
KCCQ71-4	CCQ7.1-4SDS2.5	3	7-1/8	3-5/8	6-1/2	11	16	WS3	14	WS3	48125	<b>7180</b>		
KCCQ71-6	CCQ7.1-6SDS2.5	3	7-1/8	5-1/2	6-1/2	11	16	WS3	14	WS3	48125	<b>7180</b>		
KCCQ71-71	CCQ7.1-7.1SDS2.5	3	7-1/8	7-1/8	6-1/2	11	16	WS3	14	WS3	48125	<b>7180</b>		
KCCQ71-8	CCQ7.1-8SDS2.5	3	7-1/8	7-1/2	6-1/2	11	16	WS3	14	WS3	48125	<b>7180</b>		
KCCQ84	--	7	7-1/2	3-5/8	6-1/2	11	16	WS3	14	WS3	51565	<b>7180</b>		
KCCQ86	CCQ86SDS2.5	7	7-1/2	5-1/2	6-1/2	11	16	WS3	14	WS3	51565	<b>7180</b>		
KCCQ88	CCQ88SDS2.5	7	7-1/2	7-1/2	6-1/2	11	16	WS3	14	WS3	51565	<b>7180</b>		
KCCQ94	--	7	8-7/8	3-5/8	6-1/2	11	16	WS3	14	WS3	60155	<b>7180</b>		
KCCQ96	CCQ96SDS2.5	7	8-7/8	5-1/2	6-1/2	11	16	WS3	14	WS3	60155	<b>7180</b>		
KCCQ98	CCQ98SDS2.5	7	8-7/8	7-1/2	6-1/2	11	16	WS3	14	WS3	60155	<b>7180</b>		
KCCQ106	CCQ106SDS2.5	7	9-1/2	5-1/2	6-1/2	11	16	WS3	14	WS3	65315	<b>7180</b>		
<b>End Column Caps</b>														
KECCQ325-4	ECCQ3-4SDS2.5	7	3-1/4	3-5/8	6-1/2	7-1/2	16	WS3	14	WS3	14650	<b>6950</b>		
KECCQ325-6	ECCQ3-6SDS2.5	7	3-1/4	5-1/2	6-1/2	7-1/2	16	WS3	14	WS3	14650	<b>6950</b>		
KECCQ44	ECCQ44SDS2.5	7	3-5/8	3-5/8	6-1/2	8-1/2	16	WS3	14	WS3	16965	<b>6950</b>		
KECCQ45	--	7	3-5/8	5-3/8	6-1/2	7-1/2	16	WS3	14	WS3	16405	<b>6950</b>		
KECCQ46	ECCQ46SDS2.5	7	3-5/8	5-1/2	6-1/2	8-1/2	16	WS3	14	WS3	18595	<b>6950</b>		
KECCQ47	--	7	3-5/8	7-1/8	6-1/2	9-1/2	16	WS3	14	WS3	20780	<b>6950</b>		
KECCQ47X	--	7	3-5/8	7-1/8	6-1/2	9-1/2	16	WS3	14	WS3	20780	<b>6950</b>		
KECCQ48	ECCQ48SDS2.5	7	3-5/8	7-1/2	6-1/2	8-1/2	16	WS3	14	WS3	18595	<b>6950</b>		
KECCQ525-4	ECCQ5-4SDS2.5	3	5-1/4	3-5/8	8	9-1/2	16	WS3	14	WS3	22330	<b>6950</b>		
KECCQ525-6	ECCQ5-6SDS2.5	3	5-1/4	5-1/2	8	9-1/2	16	WS3	14	WS3	27300	<b>6950</b>		
KECCQ525-8	ECCQ5-8SDS2.5	3	5-1/4	7-1/2	8	9-1/2	16	WS3	14	WS3	30430	<b>6950</b>		
KECCQ57	--	7	5-3/8	7-1/8	6-1/2	9-1/2	16	WS3	14	WS3	<b>31170</b>	<b>6950</b>		
KECCQ64	ECCQ64SDS2.5	7	5-1/2	3-5/8	6-1/2	8-1/2	16	WS3	14	WS3	23535	<b>6950</b>		
KECCQ66	ECCQ66SDS2.5	7	5-1/2	5-1/2	6-1/2	8-1/2	16	WS3	14	WS3	28910	<b>6950</b>		
KECCQ67X	ECCQ6-7.13SDS2.5	7	5-1/2	7-1/8	6-1/2	8-1/2	16	WS3	14	WS3	29220	<b>6950</b>		
KECCQ68	ECCQ68SDS2.5	7	5-1/2	7-1/2	6-1/2	8-1/2	16	WS3	14	WS3	29220	<b>6950</b>		
KECCQ74	ECCQ74SDS2.5	3	6-7/8	3-5/8	6-1/2	8-1/2	16	WS3	14	WS3	27465	<b>6950</b>		
KECCQ76	ECCQ76SDS2.5	3	6-7/8	5-1/2	6-1/2	8-1/2	16	WS3	14	WS3	35860	<b>6950</b>		
KECCQ77	ECCQ77SDS2.5	3	6-7/8	6-7/8	6-1/2	8-1/2	16	WS3	14	WS3	35860	<b>6950</b>		
KECCQ78	ECCQ78SDS2.5	3	6-7/8	7-1/2	6-1/2	8-1/2	16	WS3	14	WS3	35860	<b>6950</b>		
KECCQ71-4	ECCQ7.1-4SDS2.5	3	7-1/8	3-5/8	6-1/2	8-1/2	16	WS3	14	WS3	28240	<b>6950</b>		
KECCQ71-6	ECCQ7.1-6SDS2.5	3	7-1/8	5-1/2	6-1/2	8-1/2	16	WS3	14	WS3	35285	<b>6950</b>		
KECCQ71-71	ECCQ7.1-7.1SDS2.5	3	7-1/8	7-1/8	6-1/2	8-1/2	16	WS3	14	WS3	37190	<b>6950</b>		
KECCQ71-8	ECCQ7.1-8SDS2.5	3	7-1/8	7-1/2	6-1/2	8-1/2	16	WS3	14	WS3	37190	<b>6950</b>		
KECCQ84	--	7	7-1/2	3-5/8	6-1/2	8-1/2	16	WS3	14	WS3	29785	<b>6950</b>		
KECCQ86	ECCQ86SDS2.5	7	7-1/2	5-1/2	6-1/2	8-1/2	16	WS3	14	WS3	37390	<b>6950</b>		
KECCQ88	ECCQ88SDS2.5	7	7-1/2	7-1/2	6-1/2	8-1/2	16	WS3	14	WS3	39845	<b>6950</b>		
KECCQ94	--	7	8-7/8	3-5/8	6-1/2	8-1/2	16	WS3	14	WS3	33595	<b>6950</b>		
KECCQ96	ECCQ96SDS2.5	7	8-7/8	5-1/2	6-1/2	8-1/2	16	WS3	14	WS3	42630	<b>6950</b>		
KECCQ98	ECCQ98SDS2.5	7	8-7/8	7-1/2	6-1/2	8-1/2	16	WS3	14	WS3	46485	<b>6950</b>		
KECCQ106	ECCQ106SDS2.5	7	9-1/2	5-1/2	6-1/2	8-1/2	16	WS3	14	WS3	45760	<b>6950</b>		

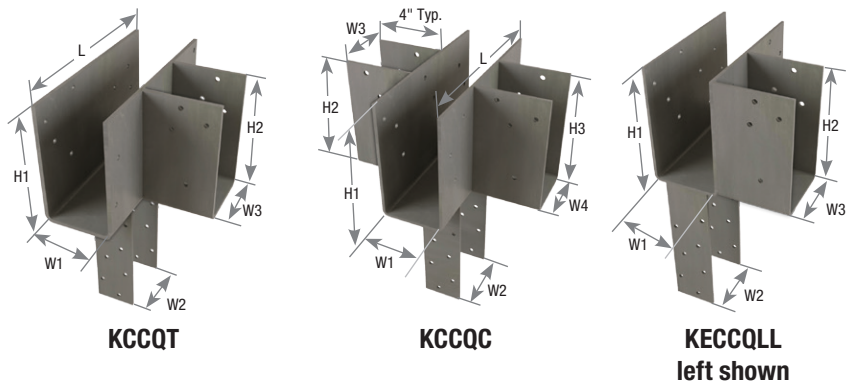
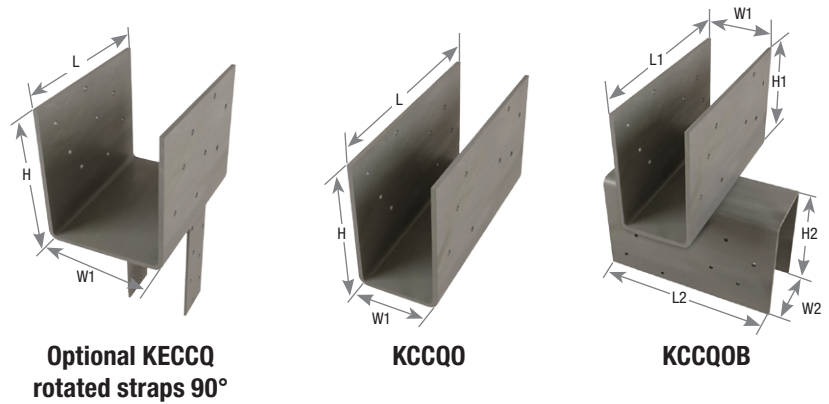
- Bearing loads are based on 625 psi perpendicular to grain loading; no further increase for duration of load is permitted.
  - Uplift loads have been increased 60% for wind or seismic loads; no further increase shall be permitted.
  - Allowable loads are based on lumber with a specific gravity of 0.50 and a moisture content of 19% or less.
  - WS3 Wood Screws are 1/4" x 3" long and are included with KCCQ and KECCQ column caps.
  - Beams shall be designed to support the required loads. Beam shear may limit loads to less than listed loads for device.
  - The designer shall check post for required loads.
  - Spliced conditions must be detailed by the specifier to transfer tension loads between spliced members by means other than the column cap.
  - Uplift loads do not apply to splice conditions.
- New products or updated product information are designated in **blue font**.

**Corrosion Finish**

<span style="color: blue;">■</span> Stainless Steel	<span style="color: orange;">■</span> Gold Coat
<span style="color: gray;">■</span> HDG	<span style="color: green;">■</span> Triple Zinc

**Specialty Options:**

- **KECCQ** – Straps may be rotated 90° on special order where the W2 dimension is less than or equal to the W1 dimension.
- **KCCQO/KECCQO** – Cap only, no strap design for field welding to pipe or other columns.
- **KCCQOB** – For cross beam connections. Any two buckets can be welded together for a wide variety of applications. Allowable load shall be the lesser of the two components.
- **KCCQT** – For T beam intersections, consult MiTek. Specify beam/column conditions, dimensions, and loading requirements.
- **KCCQC** – For X beam intersections, consult MiTek. Specify beam/column conditions, dimensions, and loading requirements.
- **KECCQLL/R** – For L beam intersections, consult MiTek. Specify left (L) or right (R) beam/column conditions, dimensions, and loading requirements.

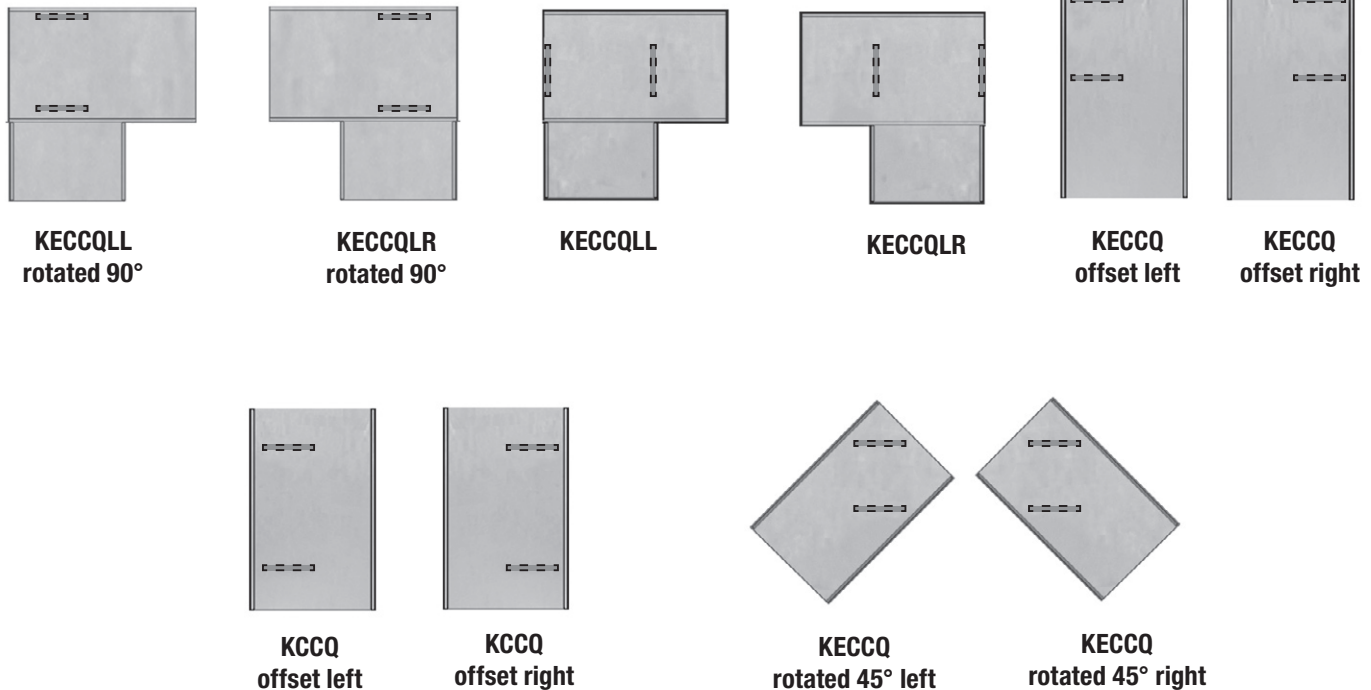


Dimension call-outs not shown in the table must be specified at time of ordering for specialty options, non-catalog, or rough/full size lumber sizes.

Refer to Options for Multiple-Beam Column Caps Special Order Worksheet for ordering instructions at [MiTek-US.com](http://MiTek-US.com).

Caps & Bases

**Top View of Specialty Options Column Cap Configurations**



**KCC** – Standard column cap.

**KECC** – End column version.

**Materials:** See chart

**Finish:** Primer

**Options:** See chart for Corrosion Finish Options.

See page 97 for Specialty Options. All nominal lumber sizes are available for rough/full size lumber.

**Codes:** See page 12 for Code Reference Chart

**Installation:**

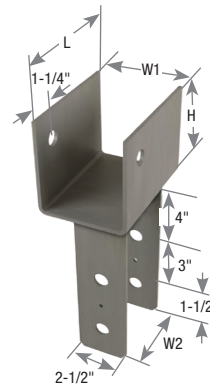
- Use all specified fasteners. See Product Notes, page 20.
- Bolt holes should be a minimum of 1/32" to a maximum of 1/16" larger than the bolt diameter.
- Beams shall be designed to support the required loads. Beam shear may limit loads to less than listed loads for device. A design professional shall determine the adequacy of the post and beam to resist published loads.



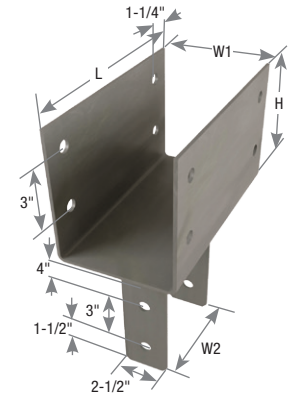
**Typical KECC44 end cap installation**



**Typical KCC center cap installation**



**KECC44**



**KCC**

MiTek USP Stock No.	Ref. No.	Steel Gauge	Dimensions (in)				Fastener Schedule <sup>4</sup>		DF/SP Allowable Loads (Lbs.) <sup>3</sup>		Corrosion Finish	Code Ref.
			W1	W2	H	L	Beam	Column or Post	Bearing <sup>1</sup>	Uplift <sup>2,8</sup>		
									100%	160%		
<b>Center Column Caps</b>												
KCC325-4	CC31/4-4	7	3-1/4	3-5/8	6-1/2	11	(4) 5/8	(2) 5/8	21485	3505		IBC, FL, LA
KCC325-6	CC31/4-6	7	3-1/4	5-1/2	6-1/2	11	(4) 5/8	(2) 5/8	21485	3505		
KCC44	CC44	7	3-5/8	3-5/8	4	7	(2) 5/8	(2) 5/8	15315	3920		
KCC45	--	7	3-5/8	5-3/8	6-1/2	11	(4) 5/8	(2) 5/8	24065	3920		
KCC46	CC46	7	3-5/8	5-1/2	6-1/2	11	(4) 5/8	(2) 5/8	24065	3920		
KCC47	--	7	3-5/8	7-1/8	6-1/2	11	(4) 5/8	(2) 5/8	24065	3920		
KCC48	CC48	7	3-5/8	7-1/2	6-1/2	11	(4) 5/8	(2) 5/8	24065	3920		
KCC525-4	CC51/4-4	3	5-1/4	3-5/8	8	13	(4) 3/4	(2) 3/4	41640	8155		
KCC525-6	CC51/4-6	3	5-1/4	5-1/2	8	13	(4) 3/4	(2) 3/4	41640	8155		
KCC525-8	CC51/4-8	3	5-1/4	7-1/2	8	13	(4) 3/4	(2) 3/4	41640	8155		
KCC57	CC6-71/8	7	5-3/8	7-1/8	6-1/2	11	(4) 5/8	(2) 5/8	36095	4145		
KCC64	CC64	7	5-1/2	3-5/8	6-1/2	11	(4) 5/8	(2) 5/8	37815	4145		
KCC66	CC66	7	5-1/2	5-1/2	6-1/2	11	(4) 5/8	(2) 5/8	37815	4145		
KCC68	CC68	7	5-1/2	7-1/2	6-1/2	11	(4) 5/8	(2) 5/8	37815	4145		

- 1) Bearing loads are based on 625 psi perpendicular to grain loading; no further increase for duration of load is permitted.
- 2) Uplift loads have been increased 60% for wind or seismic loads; no further increase shall be permitted.
- 3) Allowable loads are based on lumber with a specific gravity of 0.50 and a moisture content of 19% or less.
- 4) All bolts shall meet or exceed the specifications of ASTM A 307.
- 5) Beams shall be designed to support the required loads. Beam shear may limit loads to less than listed loads for device.
- 6) The designer shall check post for required loads.
- 7) Spliced conditions must be detailed by the specifier to transfer tension loads between spliced members by means other than the column cap.
- 8) Uplift loads do not apply to splice conditions.

**Corrosion Finish** ■ Stainless Steel ■ Gold Coat ■ HDG ■ Triple Zinc

## Installation:

- Use all specified fasteners. See Product Notes, page 20.
- Bolt holes should be a minimum of 1/32" to a maximum of 1/16" larger than the bolt diameter.
- Beams shall be designed to support the required loads. Beam shear may limit loads to less than listed loads for device. A design professional shall determine the adequacy of the post and beam to resist published loads.

MiTek USP Stock No.	Ref. No.	Steel Gauge	Dimensions (in)				Fastener Schedule <sup>4</sup>		DF/SP Allowable Loads (Lbs.) <sup>3</sup>		Corrosion Finish	Code Ref.
			W1	W2	H	L	Beam	Column or Post	Bearing <sup>1</sup>	Uplift <sup>2,8</sup>		
									100%	160%		
<b>Center Column Caps</b>												
KCC74	CC74	3	6-7/8	3-5/8	8	13	(4) 3/4	(2) 3/4	54845	8155		IBC, FL, LA
KCC76	CC76	3	6-7/8	5-1/2	8	13	(4) 3/4	(2) 3/4	54845	8155		
KCC77	CC77	3	6-7/8	6-7/8	8	13	(4) 3/4	(2) 3/4	54845	8155		
KCC78	CC78	3	6-7/8	7-1/2	8	13	(4) 3/4	(2) 3/4	54845	8155		
KCC75X	CC71/8-6	3	7-1/8	5-1/2	8	13	(4) 3/4	(2) 3/4	56875	8155		
KCC77X	CC71/8-71/8	3	7-1/8	7-1/8	8	13	(4) 3/4	(2) 3/4	56875	8155		
KCC84	CC84	3	7-1/2	3-5/8	8	13	(4) 3/4	(2) 3/4	60940	8155		
KCC86	CC86	3	7-1/2	5-1/2	8	13	(4) 3/4	(2) 3/4	60940	8155		
KCC88	CC88	3	7-1/2	7-1/2	8	13	(4) 3/4	(2) 3/4	60940	8155		
KCC94	CC94	3	8-7/8	3-5/8	8	13	(4) 3/4	(2) 3/4	71095	8155		
KCC96	CC96	3	8-7/8	5-1/2	8	13	(4) 3/4	(2) 3/4	71095	8155		
KCC98	CC98	3	8-7/8	7-1/2	8	13	(4) 3/4	(2) 3/4	71095	8155		
KCC106	CC106	3	9-5/8	5-1/2	8	13	(4) 3/4	(2) 3/4	77190	8155		
<b>End Column Caps</b>												
KECC325-4	ECC31/4-4	7	3-1/4	3-5/8	6-1/2	7-1/2	(2) 5/8	(2) 5/8	14650	1750		IBC, FL, LA
KECC325-6	ECC31/4-6	7	3-1/4	5-1/2	6-1/2	7-1/2	(2) 5/8	(2) 5/8	14650	1750		
KECC44	ECC44	7	3-5/8	3-5/8	4	5-1/2	(1) 5/8	(2) 5/8	12030	1960		
KECC45	--	7	3-5/8	5-3/8	6-1/2	7-1/2	(2) 5/8	(2) 5/8	16405	1960		
KECC46	ECC46	7	3-5/8	5-1/2	6-1/2	8-1/2	(2) 5/8	(2) 5/8	18595	1960		
KECC47	--	7	3-5/8	7-1/8	6-1/2	9-1/2	(2) 5/8	(2) 5/8	20780	1960		
KECC48	ECC48	7	3-5/8	7-1/2	6-1/2	9-1/2	(2) 5/8	(2) 5/8	20780	1960		
KECC525-4	ECC51/4-4	3	5-1/4	3-5/8	8	9-1/2	(2) 3/4	(2) 3/4	30430	<b>6050</b>		
KECC525-6	ECC51/4-6	3	5-1/4	5-1/2	8	9-1/2	(2) 3/4	(2) 3/4	30430	<b>6050</b>		
KECC525-8	ECC51/4-8	3	5-1/4	7-1/2	8	9-1/2	(2) 3/4	(2) 3/4	30430	<b>6050</b>		
KECC57	ECC6-71/8	7	5-3/8	7-1/8	6-1/2	9-1/2	(2) 5/8	(2) 5/8	31170	<b>2105</b>		
KECC64	ECC64	7	5-1/2	3-5/8	6-1/2	7-1/2	(2) 5/8	(2) 5/8	25780	<b>2105</b>		
KECC66	ECC66	7	5-1/2	5-1/2	6-1/2	7-1/2	(2) 5/8	(2) 5/8	25780	<b>2105</b>		
KECC68	ECC68	7	5-1/2	7-1/2	6-1/2	9-1/2	(2) 5/8	(2) 5/8	32655	<b>2105</b>		
KECC74	ECC74	3	6-7/8	3-5/8	8	10-1/2	(2) 3/4	(2) 3/4	44295	<b>6050</b>		
KECC76	ECC76	3	6-7/8	5-1/2	8	10-1/2	(2) 3/4	(2) 3/4	44295	<b>6050</b>		
KECC77	ECC77	3	6-7/8	6-7/8	8	10-1/2	(2) 3/4	(2) 3/4	44295	<b>6050</b>		
KECC78	ECC78	3	6-7/8	7-1/2	8	10-1/2	(2) 3/4	(2) 3/4	44295	<b>6050</b>		
KECC75X	ECC71/8-6	3	7-1/8	5-1/2	8	10-1/2	(2) 3/4	(2) 3/4	45940	<b>6050</b>		
KECC77X	ECC71/8-71/8	3	7-1/8	7-1/8	8	10-1/2	(2) 3/4	(2) 3/4	45940	<b>6050</b>		
KECC84	ECC84	3	7-1/2	3-5/8	8	10-1/2	(2) 3/4	(2) 3/4	49220	<b>6050</b>		
KECC86	ECC86	3	7-1/2	5-1/2	8	10-1/2	(2) 3/4	(2) 3/4	49220	<b>6050</b>		
KECC88	ECC88	3	7-1/2	7-1/2	8	10-1/2	(2) 3/4	(2) 3/4	49220	<b>6050</b>		
KECC94	ECC94	3	8-7/8	3-5/8	8	10-1/2	(2) 3/4	(2) 3/4	57420	<b>6050</b>		
KECC96	ECC96	3	8-7/8	5-1/2	8	10-1/2	(2) 3/4	(2) 3/4	57420	<b>6050</b>		
KECC98	ECC98	3	8-7/8	7-1/2	8	10-1/2	(2) 3/4	(2) 3/4	57420	<b>6050</b>		
KECC106	ECC106	3	9-5/8	5-1/2	8	10-1/2	(2) 3/4	(2) 3/4	62345	<b>6050</b>		

1) Bearing loads are based on 625 psi perpendicular to grain loading; no further increase for duration of load is permitted.

2) Uplift loads have been increased 60% for wind or seismic loads; no further increase shall be permitted.

3) Allowable loads are based on lumber with a specific gravity of 0.50 and a moisture content of 19% or less.

4) All bolts shall meet or exceed the specifications of ASTM A 307.

5) Beams shall be designed to support the required loads. Beam shear may limit loads to less than listed loads for device.

6) The designer shall check post for required loads.

7) Spliced conditions must be detailed by the specifier to transfer tension loads between spliced members by means other than the column cap.

8) Uplift loads do not apply to splice conditions.

New products or updated product information are designated in **blue font**.

**Corrosion Finish** ■ Stainless Steel ■ Gold Coat ■ HDG ■ Triple Zinc

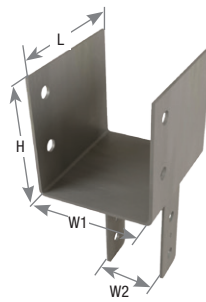


**Specialty Options:**

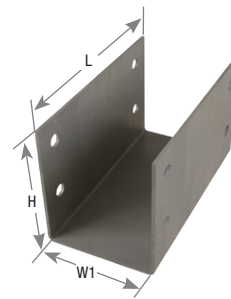
- **KECC** – Straps may be rotated 90° on special order where the W2 dimension is less than or equal to the W1 dimension. Unless specified W3 and W4 dimensions are equal to the W1 dimension, and H2 and H3 dimensions are equal to the H1 dimension.
- **KCCO/KECCO** – Cap only, no strap design for field welding to pipe or other columns.
- **KCCOB** – For cross beam connections. Any two buckets can be welded together for a wide variety of applications. Allowable load shall be the lesser of the two components.
- **KCCT** – For T beam intersections, consult MiTek. Specify beam/column conditions, dimensions, and loading requirements.
- **KCCC** – For X beam intersections, consult MiTek. Specify beam/column conditions, dimensions, and loading requirements.
- **KECCLL/R** – For L beam intersections, consult MiTek. Specify left (L) or right (R) beam/column conditions, dimensions, and loading requirements.

**Dimension call-outs not shown in the table must be specified at time of ordering for specialty options, non-catalog, or rough/full size lumber sizes.**

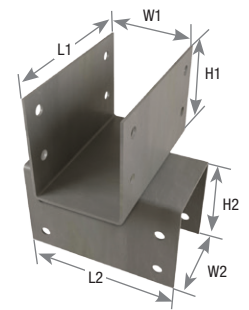
Refer to Options for Multiple-Beam Bolted Column Caps Special Order Worksheet for ordering instructions at [MiTek-US.com](http://MiTek-US.com).



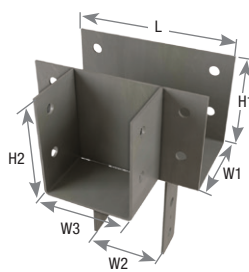
**Optional KECC  
rotated straps 90°**



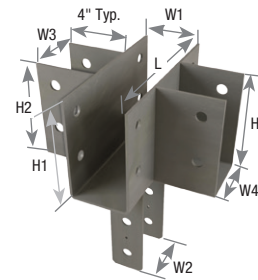
**KCCO**



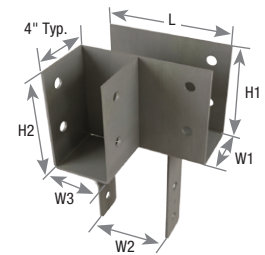
**KCCOB**



**KCCT**



**KCCC**



**KECCLL  
left shown**

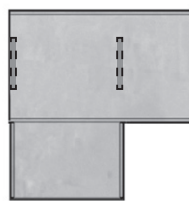
**Top View of Specialty Options Column Cap Configurations**



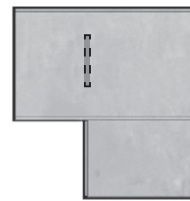
**KECCLL  
rotated 90°**



**KECCLR  
rotated 90°**



**KECCLL**



**KECCLR**



**KECC  
offset left**



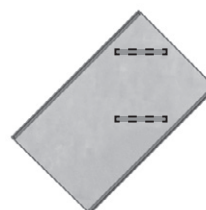
**KECC  
offset right**



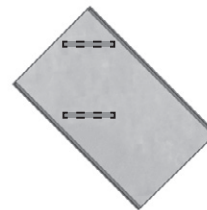
**KCC  
offset left**



**KCC  
offset right**



**KECC  
rotated 45° left**



**KECC  
rotated 45° right**

**MP** – 18 gauge. Field adjustable from 45° to 180° (flat).

**A3** – 18 gauge. Eliminates toenailing and increases strength.

**AC** – 16 gauge. Features staggered nail patterns which reduces wood splitting and allows installation on both sides of the supported member.

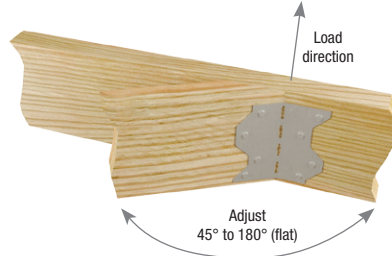
**JA** – 14 or 16 gauge. Heavier capacity framing angle for joist support.

**Materials:** See chart

**Finish:** G90 galvanizing

**Options:** See chart for Corrosion Finish Options

**Codes:** See page 12 for Code Reference Chart

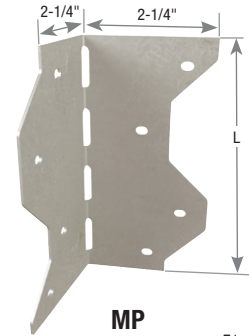


**Typical MP installation**



**Typical MP rafter support installation**

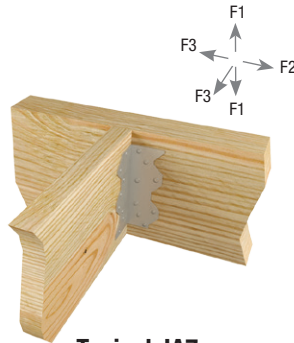
AVAILABLE IN  
**GOLD COAT**



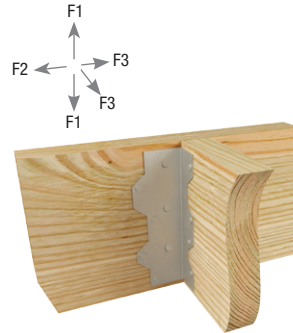
**MP**



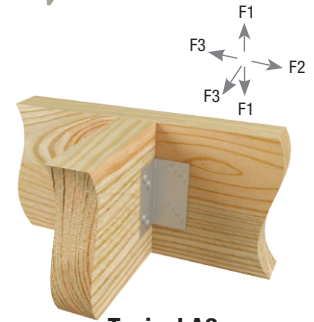
**Typical JA1 installation**



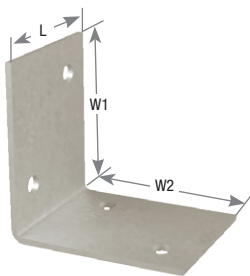
**Typical JA7 installation**



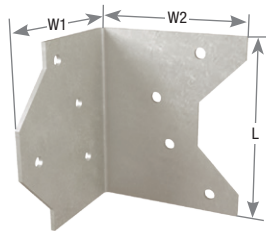
**Typical AC installation**



**Typical A3 installation**



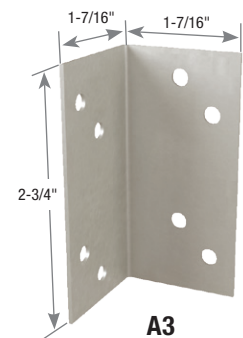
**JA1**



**JA3**



**AC**



**A3**

**Installation:**

- Use all specified fasteners. See Product Notes, page 20.
- MP Framing Angles are fabricated at 100° and may be field adjusted by hand from 45° to 180° (flat). Bend angle only once.

MiTek USP Stock No.	Ref. No.	Steel Gauge	Dimensions (in)			Fastener Schedule <sup>3,4</sup>				Direction of Load	DF/SP Allowable Loads (Lbs.) <sup>1,2</sup>				S-P-F Allowable Loads (Lbs.) <sup>1,2</sup>				Corrosion Finish	Code Ref.	
						Header		Joist			Qty	Type	Qty	Type	100%	115%	125%	160%			100%
			W1	W2	L	Qty	Type	Qty	Type												
A3	A23, GA1, GA2, L30	18	1-7/16	1-7/16	2-3/4	4	10d x 1-1/2	4	10d x 1-1/2	F1	480	545	590	740	410	470	510	520	Green		
										F2	480	545	590	610	410	470	485	485			
										F3	375	375	375	375	145	165	180	230			
MP3	LS30	18	2-1/4	2-1/4	3-3/8	3	10d	3	10d	F1	360	410	445	455	310	350	380	380	Green		
MP5	LS50	18	2-1/4	2-1/4	4-5/8	4	10d	4	10d	F1	480	545	590	740	410	470	505	640	Blue		
MP7	LS70	18	2-1/4	2-1/4	5-7/8	5	10d	5	10d	F1	600	685	740	930	515	585	630	800	Blue		
MP9	LS90	18	2-1/4	2-1/4	6-7/8	6	10d	6	10d	F1	720	820	885	1115	620	705	760	960	Blue		
AC5	L50	16	1-5/16	2-3/8	4-7/8	3	10d	3	10d	F1	375	420	455	565	310	360	390	500	Green		
										F2	375	420	455	565	310	360	390	500			
										F3	155	180	195	250	215	250	270	345			
						3	16d	3	16d	F1	440	500	540	670	370	425	460	545			
										F2	440	500	540	595	370	425	460	590			
										F3	175	205	220	280	280	320	345	445			
AC7	L70	16	1-5/16	2-3/8	6-15/16	4	10d	4	10d	F1	500	560	605	755	415	480	520	665	Green		
										F2	500	560	605	755	415	480	520	665			
										F3	210	240	260	335	290	330	360	460			
						4	16d	4	16d	F1	590	665	720	895	495	565	615	770			
										F2	590	665	720	895	495	565	615	790			
										F3	235	270	295	375	370	425	465	590			
AC9	L90	16	1-5/16	2-3/8	8-7/8	5	10d	5	10d	F1	625	700	755	945	520	595	650	830	Green	IBC, FL, LA	
										F2	625	700	755	900	520	595	650	830			
										F3	260	300	325	415	360	415	450	580			
						5	16d	5	16d	F1	735	835	900	1120	615	710	770	985			
										F2	735	835	900	900	615	710	770	920			
										F3	295	340	370	470	465	530	580	740			
JA1	A21	16	1-1/2	1-1/2	1-1/4	2	10d x 1-1/2	2	10d x 1-1/2	F1	220	220	220	220	195	195	195	195	Green		
										F2	--	--	--	300	--	--	--	235			
										F3	--	--	--	150	--	--	--	100			
JA3	--	14	2-1/2	2-1/2	3	4	16d	4	10d x 1-1/2	F1	495	495	495	495	445	445	445	445	Green		
										F2	--	--	--	465	--	--	--	365			
										F3	--	--	--	330	--	--	--	225			
JA5	--	14	2-1/2	2-1/2	5	6	16d	6	10d x 1-1/2	F1	790	825	825	825	715	740	740	740	Green		
										F2	--	--	--	890	--	--	--	695			
										F3	--	--	--	495	--	--	--	335			
JA7	--	14	2-1/2	2-1/2	7	8	16d	8	10d x 1-1/2	F1	1055	1185	1270	1560	955	1070	1145	1410	Green		
										F2	--	--	--	1450	--	--	--	1135			
										F3	--	--	--	490	--	--	--	335			
JA9	--	14	2-1/2	2-1/2	9	10	16d	10	10d x 1-1/2	F1	1320	1485	1590	1950	1190	1340	1430	1760	Green		
										F2	--	--	--	1465	--	--	--	1150			
										F3	--	--	--	775	--	--	--	530			

Copyright © 2018 MiTek Industries, Inc. All Rights Reserved

1) Allowable loads have been increased 60% for wind and seismic loads; no further increase shall be permitted.  
 2) Loads are shown per angle, and may be doubled if installed in pairs. When using a single angle, joist must be constrained from rotation.  
 3) For 1-1/2" lumber, use 0.98 of table load for 10d nails and 0.92 for 16d nails.  
 4) **NAILS:** 10d x 1-1/2 nails are 0.148" dia. x 1-1/2" long, 10d nails are 0.148" dia. x 3" long, 16d nails are 0.162" dia. x 3-1/2" long.  
 New products or updated product information are designated in **blue font**.

**Corrosion Finish**  
■ Stainless Steel ■ Gold Coat  
■ HDG ■ Triple Zinc

ML angles are multi-purpose angles that install easily with MiTek's WS15 wood screws. The staggered fastener pattern allows for back-to-back installations.

**Materials:** 12 gauge

**Finish:** G-185 galvanizing

**Codes:** See page 12 for Code Reference Chart

**Installation:**

- Use all specified fasteners. See Product Notes, page 20.
- MiTek WS15 (1/4" x 1-1/2") are not supplied with ML angles.



**Typical ML26-TZ installation**  
(ML24-TZ similar)



**ML26-TZ**  
(ML24-TZ similar)

MiTek USP Stock No.	Ref. No.	Steel Gauge	Dimensions (in)		Fastener Schedule <sup>2,3</sup>			DF/SP Allowable Loads (Lbs.) <sup>1</sup>				S-P-F Allowable Loads (Lbs.) <sup>1</sup>				Corrosion Finish	Code Ref.
			W	H	Header Qty	Joist Qty	Type	F1				F1					
								100%	115%	125%	160%	100%	115%	125%	160%		
ML24-TZ	ML24Z	12	2	4	3	3	WS15	645	645	645	645	540	540	540	540	IBC,	
ML26-TZ	ML26Z	12	2	6	4	4	WS15	920	1060	1075	1075	755	865	905	905	FL, LA	

1) Allowable loads have been increased 60% for wind and seismic loads; no further increase shall be permitted.  
 2) WS15 Wood Screws are 1/4" dia. x 1-1/2" long and are not included with angles.  
 3) For exterior applications use WS15-EXT screws with exterior coat finish.  
 New products or updated product information are designated in **blue font**.

**Corrosion Finish**

- Stainless Steel
- Gold Coat
- HDG
- Triple Zinc

**RBC** Roof Boundary Clip

Framing plate designed to connect roof blocking to a wall top plate.

**Materials:** 20 gauge

**Finish:** G90 galvanizing

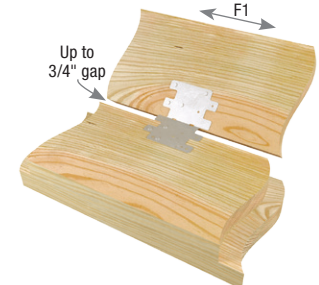
**Codes:** See page 12 for Code Reference Chart

**Installation:**

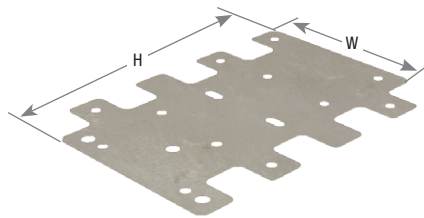
- Use all specified fasteners. See Product Notes, page 20.
- Field adjustable from 0° to 90°.
- **Bend angle only once.**



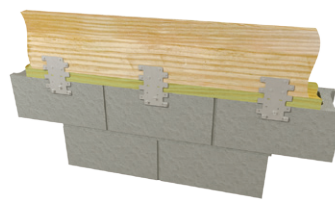
**Typical RBC top-plate to outside of blocking installation**



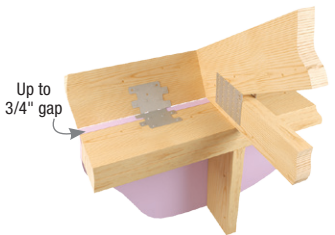
**Typical RBC top-plate to inside of blocking installation**



**RBC**



**Typical RBC concrete block wall to blocking installation**



**Typical RBC 1" foamboard installation**

MiTek USP Stock No.	Ref. No.	Steel Gauge	Dimensions (in)		Fastener Schedule <sup>3,4</sup>				DF/SP Allowable Loads (Lbs.) <sup>1,2</sup>	S-P-F Allowable Loads (Lbs.) <sup>1,2</sup>	Code Ref.	
			W	H	Top Plate		Blocking					
					Installation Type	Qty	Type <sup>2,3</sup>	Qty	Type <sup>2</sup>	F1 160%		F1 160%
RBC	RBC	20	4-1/4	6	Wood	6	10d x 1-1/2	6	10d x 1-1/2	510	430	IBC, FL, LA
					CMU	3	1/4" Tapcon	6	10d x 1-1/2	450	380	

1) Allowable loads have been increased 60% for wind or seismic loads; no further increase shall be permitted.  
 2) Loads shown are for a single roof boundary clip.  
 3) Use ITW-Buildex 1/4" x 1-1/2" Tapcons; or equal, installed in accordance with manufacturer's specifications.  
 4) **NAILS:** 10d x 1-1/2 nails are 0.148" diameter by 1-1/2" long.

**MP34** – Framing angle without tabs.

**MPA1** – Tabs enable two and three-way connections.

**MP4F** – Connects 2x framing with floor sheathing up to 5/8".

**MP6F** – Connects 3x framing with floor sheathing up to 3/4". Better choice for connections where floor sheathing is between sole plate and rim board.

**Materials:** See chart

**Finish:** G90 galvanizing

**Options:** See chart for Corrosion Finish Options

**Codes:** See page 12 for Code Reference Chart



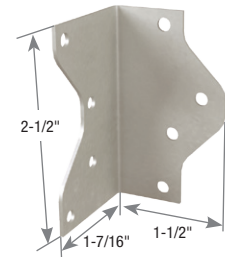
**MPA1**



**Typical MP34 installation**

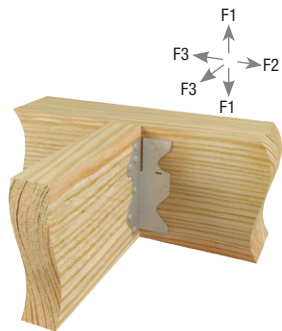


**MPA1-GC**



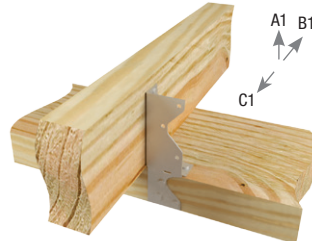
**MP34**

AVAILABLE IN  
**GOLD  
COAT**



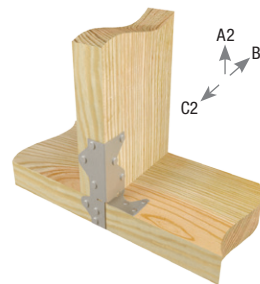
**Typical MPA1 joist / header installation**

**Figure 1**



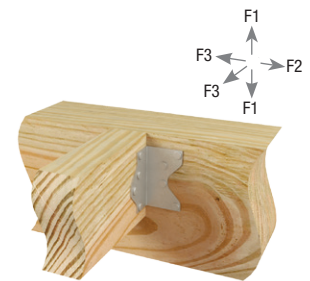
**Typical MPA1 rafter / plate installation**

**Figure 2**



**Typical MPA1 stud / plate installation**

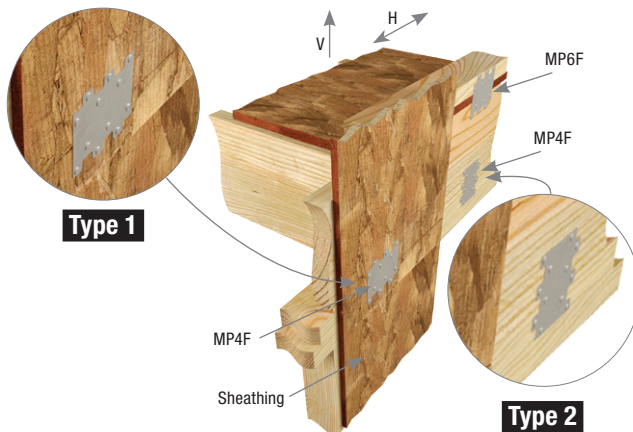
**Figure 3**



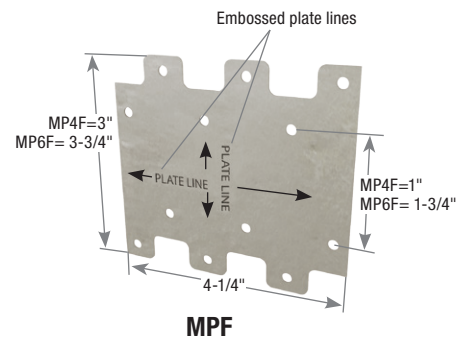
**Typical MP34 joist / header installation**

**Figure 4**

Angles & Straps



**Typical MPF installation**



**MPF**

**Installation:**

- Use all specified fasteners. See Product Notes, page 20.
- **Bend tabs only once.**
- MP4F connects 2x framing with floor sheathing up to 5/8".
- MP6F connects 3x framing with floor sheathing up to 3/4", and is a better choice for connections where floor sheathing is between sole plate and rim board.

MiTek USP Stock No.	Ref. No.	Steel Gauge	Installation Type <sup>2,4</sup>	Fastener Schedule <sup>5</sup>				Direction of Load <sup>2</sup>	DF/SP Allowable Loads (Lbs.) <sup>1,3,4</sup>				S-P-F Allowable Loads (Lbs.) <sup>1,3,4</sup>				Corrosion Finish	Code Ref.
				Header or Stud		Joist or Plate			100%	115%	125%	160%	100%	115%	125%	160%		
				Qty	Type	Qty	Type											
MPA1	A35	18	Figure 1	6	8d x 1-1/2	6	8d x 1-1/2	F1	600	625	625	625	515	525	525	525	Blue, Green, Orange	
				6	8d x 1-1/2	6	8d x 1-1/2	F2	600	685	735	750	515	585	630	630		
				6	8d x 1-1/2	6	8d x 1-1/2	F3	280	320	350	435	180	205	225	290		
			Figure 2	6	8d x 1-1/2	3	8d x 1-1/2	A1	300	340	370	380	260	295	315	320		
				6	8d x 1-1/2	3	8d x 1-1/2	B1	300	340	370	385	260	295	315	325		
				6	8d x 1-1/2	3	8d x 1-1/2	C1	260	260	260	260	215	215	215	215		
			Figure 3	6	8d x 1-1/2	6	8d x 1-1/2	A2	440	440	440	440	350	370	370	370		
				6	8d x 1-1/2	6	8d x 1-1/2	B2	240	240	240	240	200	200	200	200		
				6	8d x 1-1/2	6	8d x 1-1/2	C2	330	330	330	330	280	280	280	280		
MP34	A34	18	Figure 4	4	8d x 1-1/2	4	8d x 1-1/2	F1	400	455	490	525	345	390	420	440	Blue, Green, Orange	
				4	8d x 1-1/2	4	8d x 1-1/2	F2	400	455	490	590	345	390	420	495		
				4	8d x 1-1/2	4	8d x 1-1/2	F3	185	215	230	295	120	140	150	190		
MP4F	LTP4	20	Type 1	6	8d x 1-1/2	6	8d x 1-1/2	V	590	670	720	750	505	575	615	645	Blue, Green, Orange	IBC, FL, LA
				6	8d x 1-1/2	6	8d x 1-1/2	H	590	670	720	750	505	575	615	645		
			Type 2	6	8d x 1-1/2	6	8d x 1-1/2	V	590	670	720	750	505	575	615	645		
				6	8d x 1-1/2	6	8d x 1-1/2	H	585	585	585	585	505	575	615	645		
			Type 1	6	8d	6	8d	V	590	670	720	750	505	575	615	645		
				6	8d	6	8d	H	590	670	720	750	505	575	615	645		
			Type 2	6	8d	6	8d	V	590	670	720	750	505	575	615	645		
				6	8d	6	8d	H	585	585	585	585	505	575	615	645		
MP6F	LTP5	20	Type 1	6	8d x 1-1/2	6	8d x 1-1/2	V	590	595	595	595	505	510	510	510	Blue, Green, Orange	
				6	8d x 1-1/2	6	8d x 1-1/2	H	590	595	595	595	505	510	510	510		
			Type 2	6	8d x 1-1/2	6	8d x 1-1/2	V	590	595	595	595	505	510	510	510		
				6	8d x 1-1/2	6	8d x 1-1/2	H	590	595	595	595	505	510	510	510		
			Type 1	6	8d	6	8d	V	590	595	595	595	505	510	510	510		
				6	8d	6	8d	H	590	595	595	595	505	510	510	510		
			Type 2	6	8d	6	8d	V	590	595	595	595	505	510	510	510		
				6	8d	6	8d	H	590	595	595	595	505	510	510	510		

1) Allowable loads have been increased 60% for wind or seismic loads; no further increase shall be permitted.  
 2) Refer to drawings for installation type and definition of the various load directions.  
 3) If installing MP4F or MP6F over plywood, use 8d common nails for 100% of table load.  
 4) Loads are shown per angle. When using a single anchor, joist must be constrained from rotation.  
 5) **NAILS:** 8d x 1-1/2" nails are 0.131" dia. x 1-1/2" long, 8d nails are 0.131" dia. x 2-1/2" long  
 New products or updated product information are designated in **blue font**.

**Corrosion Finish**  
■ Stainless Steel ■ Gold Coat  
■ HDG ■ Triple Zinc

**RSPT** – 18 or 20 gauge.

**SPT** – 20 gauge.

**TSP** – 16 gauge. Optional diamond holes for various uplift capacities with Min and Max nailing configurations.

**Materials:** See chart

**Finish:** G90 galvanizing

**Options:** See chart for Corrosion Finish Options

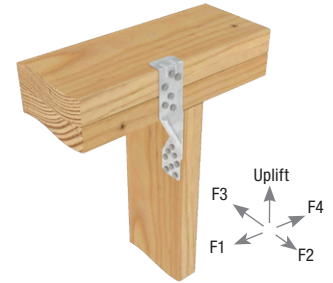
**Codes:** See page 12 for Code Reference Chart



**RSPT6-2 installation**



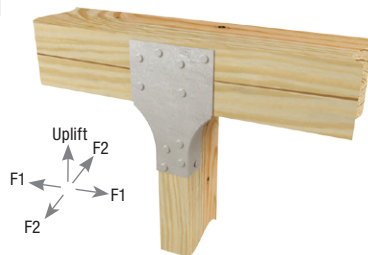
**Typical RSPT4 single plate installation**



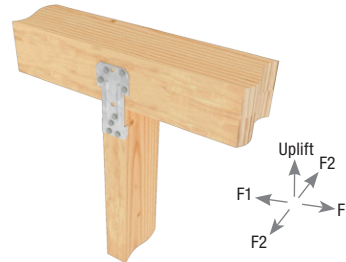
**Typical TSP top plate installation (max nailing)**

**Installation:**

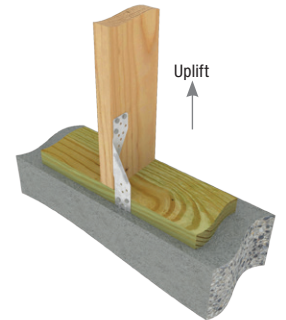
- Use all specified fasteners. See Product Notes, page 20.
- **TSP Min Nailing** – Fill all round holes.
- **TSP Max Nailing** – Fill all round and diamond holes.
- HDG nails may be required when fastening to treated sill plates.



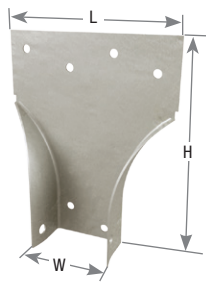
**Typical SPT24 installation**



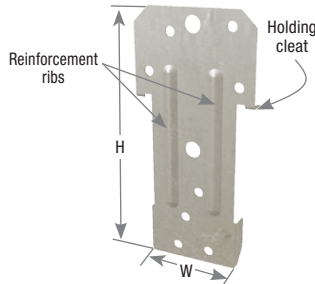
**Typical RSPT4 double plate installation**



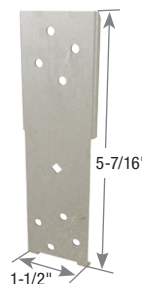
**Typical TSP-TZ mudsill installation (min nailing)**



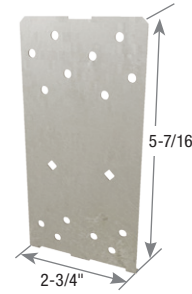
**SPT22**



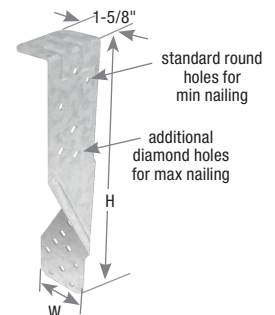
**RSPT4**



**RSPT6**



**RSPT6-2**



**TSP**

MiTek USP Stock No. <sup>2</sup>	Ref. No.	Steel Gauge	Dimensions (in)			Fastener Schedule <sup>3</sup>				DF/SP Allowable Loads (Lbs.)					Corrosion Finish	Code Ref.
			W	H	L	Stud		Plate		Uplift <sup>1</sup> 160%	F1 160%	F2 160%	F3 160%	F4 160%		
						Qty	Type	Qty	Type							
RSPT4	RSP4	20	1-1/2	4-1/8	--	4	8d x 1-1/2	4	8d x 1-1/2	460	255	300	--	--	IBC, FL, LA	
SPT22	SP1	20	1-9/16	4-3/8	3-1/2	4	10d	4	10d	735	535	275	--	--		
SPT24	SP2	20	1-9/16	5-5/8	3-1/2	6	10d	6	10d	1090	535	275	--	--		
SPT44	--	20	3-9/16	6-3/4	6-1/2	6	16d	6	16d	1315	845	275	--	--		
RSPT6	SSP	18	1-1/2	5-7/16	--	4	10d x 1-1/2	4	10d x 1-1/2	650	--	--	--	--		
RSPT6-2	DSP	18	2-3/4	5-7/16	--	8	10d x 1-1/2	6	10d x 1-1/2	900	--	--	--	--		
TSP	TSP	16	1-5/8	7-7/8	--	3	10d x 1-1/2	3	10d x 1-1/2	465	--	--	--	--		
						9	10d x 1-1/2	6	10d x 1-1/2	870	365	190	210	235		

1) Uplift loads have been increased 60% for wind or seismic loads; no further increase shall be permitted.  
 2) SPT22, SPT24, and SPT44: the two nails fastened to the wide face of the stud must be driven 30° from the perpendicular on the horizontal plane.  
 3) **NAILS:** 8d x 1-1/2 nails are 0.131" dia. x 1-1/2" long, 10d x 1-1/2 nails are 0.148" dia. x 1-1/2" long, 10d nails are 0.148" dia. x 3" long, 16d nails are 0.162" dia. x 3-1/2" long.

**Corrosion Finish**  
 ■ Stainless Steel ■ Gold Coat  
 ■ HDG ■ Triple Zinc

**SPT** – 20 gauge. Ties single and double plates to studs.

**SPTH** – Heavier 18 gauge version of SPT.

**SPTHW** – 18 gauge. Attaches plate to studs over 1/2" sheathing.

**Materials:** See chart

**Finish:** G90 galvanizing

**Options:** See chart for Corrosion Finish Options

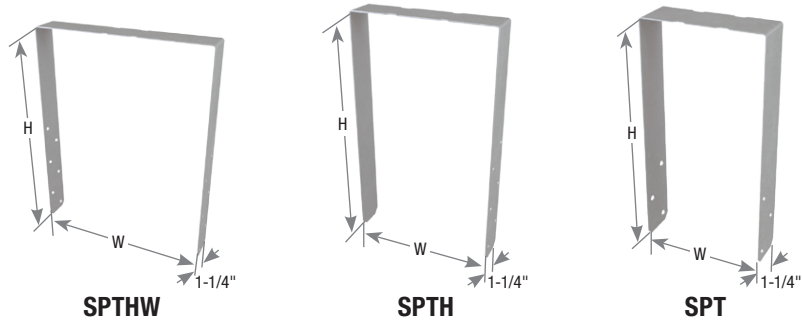
**Codes:** See page 12 for Code Reference Chart

**Installation:**

- Use all specified fasteners. See Product Notes, page 20.



**Typical SPT4 installation**



Angles & Straps

Stud Size	MiTek USP Stock No.	Ref. No.	Steel Gauge	Dimensions (in)		Fastener Schedule <sup>2</sup>		DF/SP Allowable Loads (Lbs.)	Corrosion Finish	Code Ref.
				W	H	Qty	Type	Uplift <sup>1</sup> 160%		
4x	SPT4	SP4	20	3-9/16	6-7/8	6	10d x 1-1/2	875	IBC, FL, LA	
	SPTH4	SPH4	18	3-9/16	8-5/8	12	10d x 1-1/2	2195		
	SPTHW4	SPH4R	18	4-1/16	8-3/8	12	10d x 1-1/2	2195		
6x	SPT6	SP6	20	5-9/16	7-5/8	6	10d x 1-1/2	875	IBC, FL, LA	
	SPTH6	SPH6	18	5-9/16	9-3/8	12	10d x 1-1/2	2195		
	SPTHW6	SPH6R	18	6-1/16	9-1/8	12	10d x 1-1/2	2195		
8x	SPT8	SP8	20	7-5/16	8-1/2	6	10d x 1-1/2	875	IBC, FL, LA	
	SPTH8	SPH8	18	7-5/16	8-1/2	12	10d x 1-1/2	2195		

1) Uplift loads have been increased 60% for wind or seismic loads; no further increase shall be permitted.

2) **NAILS:** 10d x 1-1/2 nails are 0.148" dia. x 1-1/2" long.

**Corrosion Finish** ■ Stainless Steel ■ Gold Coat ■ HDG ■ Triple Zinc



Framing clips replace end cripples under window sills.

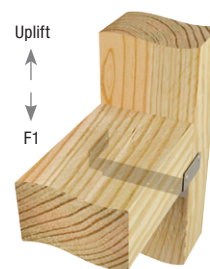
**Materials:** 16 gauge

**Finish:** G90 galvanizing

**Codes:** See page 12 for Code Reference Chart

**Installation:**

- Use all specified fasteners. See Product Notes, page 20.

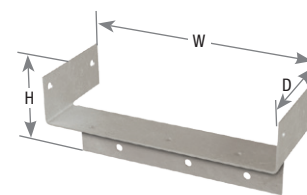


Typical SFC6 installation

MiTek USP Stock No.	Ref. No.	Steel Gauge	Dimensions (in)			Fastener Schedule <sup>2</sup>				DF/SP Allowable Loads (Lbs.) <sup>1</sup>				Code Ref.
						Sill		Stud		F1			Uplift	
			W	H	D	Qty	Type	Qty	Type	100%	115%	125%	160%	
SFC6	--	16	5-1/2	2-1/2	2-1/2	5	16d	5	16d	690	795	865	750	--

1) Allowable loads have been increased 60% for wind or seismic loads; no further increase shall be permitted.

2) **NAILS:** 16d nails are 0.162" dia. x 3-1/2" long.



SFC6

**HH Header Hangers**

Header Hangers support headers in door and window framing and help eliminate cracks in drywall, plaster, or stucco over windows and doors. These products also provide anchorage and support for heavy fence rails, struts, or gate post cross brackets.

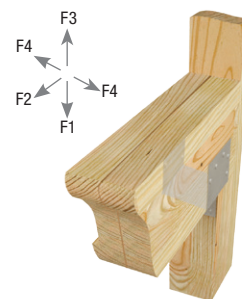
**Materials:** 16 gauge

**Finish:** G90 galvanizing

**Codes:** See page 12 for Code Reference Chart

**Installation:**

- Use all specified fasteners. See Product Notes, page 20.



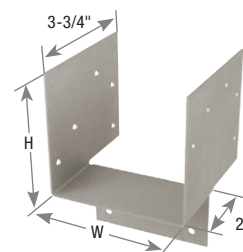
Typical HH44 installation

MiTek USP Stock No.	Ref. No.	Steel Gauge	Dimensions (in)		Fastener Schedule <sup>2</sup>				DF/SP Allowable Loads (Lbs.)						Code Ref.
					Header		Stud		F1			F2 <sup>1</sup>	F3 <sup>1</sup>	F4 <sup>1</sup>	
			W	H	Qty	Type	Qty	Type	100%	115%	125%	160%	160%	160%	
HH44	HH4	16	3-9/16	3-1/4	4	16d	9	16d	1325	1500	1620	835	895	1390	IBC, FL, LA
HH66	HH6	16	5-1/2	5-1/4	6	16d	12	16d	1765	2000	2160	1025	1345	2400	

1) Allowable loads have been increased 60% for wind or seismic loads; no further increase shall be permitted.

2) **NAILS:** 16d nails are 0.162" dia. x 3-1/2" long.

New products or updated product information are designated in **blue font**.



HH44

The LJC-TZ and LJQ-TZ Lateral Joist Connectors transfer lateral loads at the top foundation to the floor joists. The fastening patterns meet I-joist manufacturer recommendations.

**LJC-TZ** – fastens the top side of the sill plate to the underside of the floor joist preventing splitting of the bottom chord flanges, and can be installed after the floor system has been installed. The product is load rated for use with dimensional lumber floor joists as well as I-joist. It can also be used with cantilevered floor joists.

**LJQ-TZ** – is a higher capacity connector designed for higher loads. It is similar in design to a joist hanger with a seat for the floor joist to bear against and utilizes wood screws to fasten to the sill plate. MiTek’s WS15-EXT Wood Screws (included) provide quick installation without the need to predrill holes.

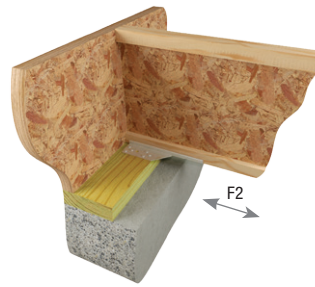
**Materials:** See chart

**Finish:** G-185 galvanizing

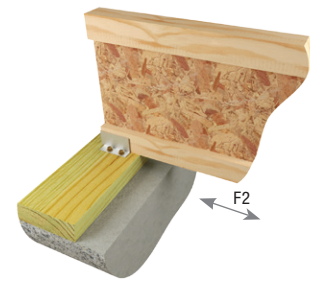
**Codes:** See page 12 for Code Reference Chart

**Installation:**

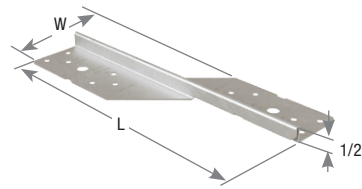
- Use all specified fasteners. See Product Notes, page 20.
- **LJC-TZ** – Installs after the floor joist has been placed with a minimum of (12) 8d x 1-1/2" HDG nails.
- **LJQ-TZ** – Installs with (4) MiTek WS15-EXT Wood Screws. WS15-EXT Wood Screws are 1/4" diameter x 1-1/2" long and are included with LJQ-TZ connectors.



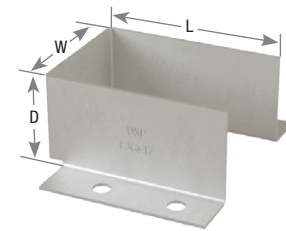
**Typical LJC-TZ installation**



**Typical LJQ-TZ installation**



**LJC-TZ**



**LJQ-TZ**

MiTek USP Stock No.	Ref. No.	Steel Gauge	Dimensions (in)			Fastener Schedule <sup>1,2</sup>		DF I-Joist Allowable Loads (Lbs.)			SP Allowable Loads (Lbs.)			Corrosion Finish	Code Ref.
			W	L	D	Qty	Type	F2			F2				
								90%	100%	160%	90%	100%	160%		
LJC-TZ	--	18	3-3/16	8	--	12	8d x 1-1/2 HDG	515	570	670	--	--	--	IBC, FL, LA	
LJQ15-TZ	--	16	1-9/16	3	1-1/2	4	WS15-EXT	--	--	--	915	1015	1110		
LJQ17-TZ	--	16	1-13/16	3	1-1/2	4	WS15-EXT	--	--	--	915	1015	1110		
LJQ20-TZ	--	16	2-1/8	3	1-1/2	4	WS15-EXT	--	--	--	915	1015	1110		
LJQ23-TZ	--	16	2-5/16	3	1-1/2	4	WS15-EXT	--	--	--	915	1015	1110		
LJQ25-TZ	--	16	2-9/16	3	1-1/2	4	WS15-EXT	--	--	--	915	1015	1110		
LJQ35-TZ	--	16	3-9/16	3	1-1/2	4	WS15-EXT	--	--	--	915	1015	1260		

1) WS15-EXT wood screws are 1/4" x 1/2" and are included with LJQ connectors.  
 2) **NAILS:** 8d x 1-1/2 nails are 0.131" dia. x 1-1/2" long.

**Corrosion Finish**

- Stainless Steel
- Gold Coat
- HDG
- Triple Zinc

Stair angles simplify stair construction. There is no need to calculate and notch stair stringers. Stronger and safer than wood blocking, and the angle and fasteners are hidden from view.

**Materials:** 12 gauge

**Finish:** G-185 galvanizing

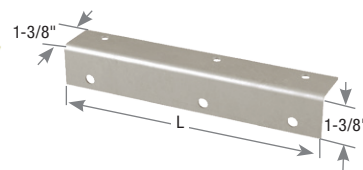
**Codes:** See page 12 for Code Reference Chart

**Installation:**

- Use all specified fasteners. See Product Notes, page 20.
- MiTek USP WS15-EXT (1/4" dia x 1-1/2") wood screws are not supplied with SCA angles.
- Use the SCA9-TZ for single 2x10 stair treads. Use the SCA10-TZ for double 2 x 6 stair treads.
- To calculate stair construction do the following:
  1. Find the number of steps needed by taking the vertical drop from the deck surface to grade. Divide by 7. Round off to the nearest whole number. (Ex: Vertical drop of 39" divided by 7 equals 5.57" rounded off is 6")
  2. Find the step rise by dividing the vertical drop by the number of steps (39" divided by 6 = 6.5")
  3. Find the step run by measuring the depth of your tread board (Ex: (2) 2x6s have a run of 11-1/4")
  4. Find the stairway span by multiplying the run by the number of treads minus one (Ex: 11-1/4" x 5 = 56-1/4")
- Using the above calculations, mark stair angle locations on each stringer. Attach a stair angle to the inside of each stringer at the marked locations. Attach stringers to deck rim joist and railing posts. Position tread-boards on angles and fasten from below.



Typical SCA9-TZ installation



SCA9-TZ



Typical SCA10-TZ installation

AVAILABLE IN  
**GOLD COAT**

MiTek USP Stock No.	Ref. No.	Steel Gauge	L (in)	Fastener Schedule <sup>2,3</sup>		DF/SP Allowable Loads (Lbs.) <sup>1</sup>	Corrosion Finish	Code Ref.
				Qty	Type			
SCA9-TZ	TA9Z	12	9	6	WS15-EXT	445		IBC, FL, LA
SCA10-TZ	TA10Z	12	10	8	WS15-EXT	595		

**Corrosion Finish**  
■ Stainless Steel  
■ Gold Coat  
■ HDG  
■ Triple Zinc

1) Loads assume rise over run of 7/11.  
 2) WS15-EXT Wood Screws are 1/4" dia. x 1-1/2" long and are not included with SCA angles.  
 3) HDG lag screws may be substituted for specified WS15-EXT screws with no load reduction.  
 New products or updated product information are designated in **blue font**.

## ANJ Heavy Angles

The ANJ44S is a 7 gauge heavy duty angle intended to securely attach a post and beam together. It is manufactured with ASTM A1011 steel and has a hot-dip galvanized finish.

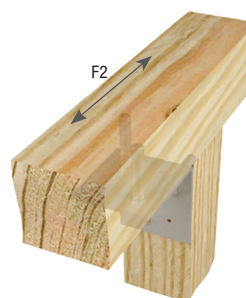
**Materials:** 7 gauge

**Finish:** Hot-dip galvanized

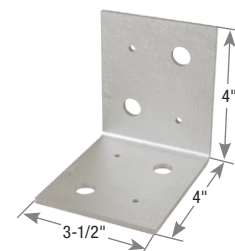
**Codes:** See page 12 for Code Reference Chart

**Installation:**

- Install with (2) 1/2" x 2-1/2" HDG lag screws into each leg.



Typical ANJ44S-HDG installation



ANJ44S-HDG

MiTek USP Stock No.	Ref. No.	Steel Gauge	Dimensions (in)			Fastener Schedule <sup>1</sup>			DF/SP Allowable Loads (Lbs.)			Corrosion Finish	Code Ref.	
			W	H	L	Header		Joist	F2					
						Qty	Lag Screw	Qty	Lag Screw	100%	115%			125%
ANJ44S-HDG	--	7	3-1/2	4	4	2	1/2" HDG	2	1/2" HDG	510	585	640		--

**Corrosion Finish**  
■ Stainless Steel  
■ Gold Coat  
■ HDG  
■ Triple Zinc

1) Loads based on use of (2) 1/2" x 2-1/2" lag screws, loaded parallel to grain, in Douglas Fir-Larch (G=0.50).

Designed for heavy-duty reinforcement of 90° framing intersections.

**Materials:** See chart

**Finish:** Primer

**Options:** See chart for Corrosion Finish Options

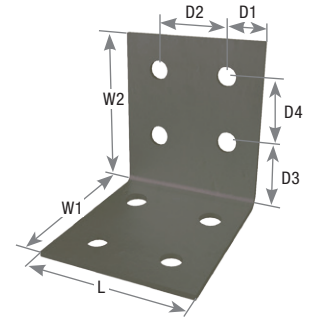
**Codes:** See page 12 for Code Reference Chart

**Installation:**

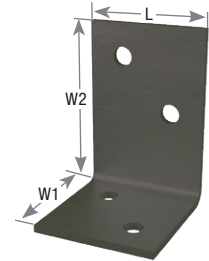
- Use all specified fasteners. See Product Notes, page 20.
- **Connectors are not load rated.**



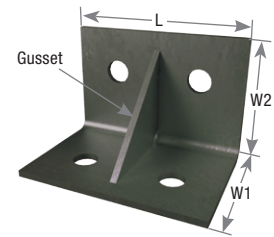
Typical KHL35 installation



KHL55



KHL335



KHL35G

MiTek USP Stock No.	Ref. No.	Steel Gauge	Dimensions (in)								Fastener Schedule			Corrosion Finish	Code Ref.
			W1	W2	L	D1	D2	D3	D4	Bolts <sup>1</sup>		Gussets			
										Qty	Dia.				
KHL33	HL33	7	3-1/4	3-1/4	2-1/2	1-1/4	--	2	--	2	5/8	--			
KHL35	HL35	7	3-1/4	3-1/4	5	1-1/4	2-1/2	2	--	4	5/8	--			
KHL35G	HL35G	7	3-1/4	3-1/4	5	1-1/4	2-1/2	2	--	4	5/8	1			
KHL37	HL37	7	3-1/4	3-1/4	7-1/2	1-1/4	2-1/2	2	--	6	5/8	--			
KHL335	SPECANGLE	3	3-1/2	5-1/4	3-1/2	--	--	--	--	4	1/2	--			
KHL43	HL43	3	4-1/4	4-1/4	3	1-1/2	--	2-3/4	--	2	3/4	--			
KHL46	HL46	3	4-1/4	4-1/4	6	1-1/2	3	2-3/4	--	4	3/4	--		--	
KHL49	HL49	3	4-1/4	4-1/4	9	1-1/2	3	2-3/4	--	6	3/4	--			
KHL53	HL53	7	5-3/4	5-3/4	2-1/2	1-1/4	--	2	2-1/2	4	5/8	--			
KHL55	HL55	7	5-3/4	5-3/4	5	1-1/4	2-1/2	2	2-1/2	8	5/8	--			
KHL57	HL57	7	5-3/4	5-3/4	7-1/2	1-1/4	2-1/2	2	2-1/2	12	5/8	--			
KHL73	HL73	3	7-1/4	7-1/4	3	1-1/2	--	2-3/4	3	4	3/4	--			
KHL76	HL76	3	7-1/4	7-1/4	6	1-1/2	3	2-3/4	3	8	3/4	1			
KHL79	HL79	3	7-1/4	7-1/4	9	1-1/2	3	2-3/4	3	12	3/4	2			

1) All bolts shall meet or exceed the specifications of ASTM A 307.

**Corrosion Finish**

- Stainless Steel
- Gold Coat
- HDG
- Triple Zinc

Angles & Straps

## B / BL Corner Braces

These multi-purpose braces are designed to provide reinforcement for 90° wood-to-wood connections.

**Materials:** 12 gauge

**Finish:** G90 galvanizing

**Codes:** See page 12 for Code Reference Chart

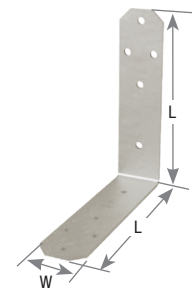
Some model designs may vary from illustration shown

**Installation:**

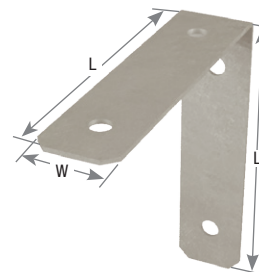
- Use all specified fasteners. See Product Notes, page 20.



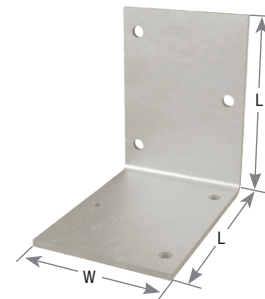
Typical B66 installation



BL4



B66



B23

MiTek USP Stock No.	Ref. No.	Steel Gauge	Dimensions (in)		Fastener Schedule				Code Ref.
			W	L	Nails <sup>2</sup>		Bolts <sup>1</sup>		
					Qty	Type	Qty	Type	
B23	--	12	2	2-5/8	6	16d	--	--	
B24	--	12	2	3-5/8	8	16d	--	--	
BL3	A33	12	1-1/4	3-1/16	8	16d	--	--	
BL4	A44	12	1-1/4	4-13/16	10	16d	--	--	--
BL6	--	12	1-1/4	6-9/16	12	16d	--	--	
BL8	--	12	1-1/4	8-5/16	14	16d	--	--	
B66	A66	12	1-1/2	6	--	--	4	3/8	
B88	A88	12	2	8	--	--	6	3/8	

1) Bolts shall conform to ASTM A 307 or better.

2) **NAILS:** 16d nails are 0.162" dia. x 3-1/2" long.

Connects 2x4 stair posts and 4x4 posts to deck rim joist or stair stringers.

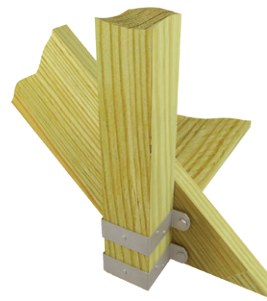
**Materials:** 14 gauge

**Finish:** G-185 galvanizing

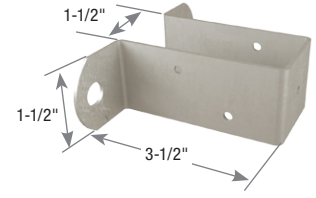
**Codes:** See page 12 for Code Reference Chart

**Installation:**

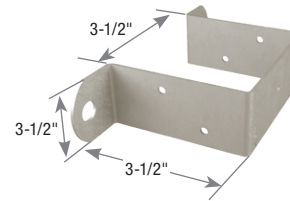
- Use all specified fasteners. See Product Notes, page 20.
- Install units in pairs on 2x4 (SDPT5-TZ) or 4x4 (SDPT7-TZ) post. Space the connectors 5" apart from center to center on the post. Use through bolts to fasten connectors to rim joist or stringer. Do not use lag bolts. Fasten to post with specified nails (see chart).



Typical SDPT7-TZ installation



SDPT5-TZ



SDPT7-TZ

Post Size	MiTek USP Stock No.	Ref. No.	Steel Gauge	Fastener Schedule				Corrosion Finish	Code Ref.
				Nails <sup>2</sup>		Bolts <sup>1</sup>			
				Qty	Type	Qty	Dia.		
2 x 4	SDPT5-TZ	DPT5Z	14	5	10d x 1-1/2 HDG	2	3/8 HDG		
4 x 4	SDPT7-TZ	DPT7Z	14	5	10d x 1-1/2 HDG	2	3/8 HDG		--

1) Bolts shall conform to ASTM A 307 or better.

2) **NAILS:** 10d x 1-1/2 nails are 0.148" dia. x 1-1/2" long.

**Corrosion Finish** ■ Stainless Steel ■ Gold Coat ■ HDG ■ Triple Zinc

# SDJT Joist Tie

Secures 2x joists to posts.

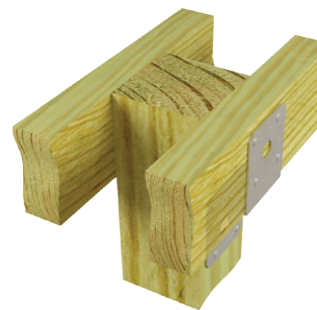
**Materials:** 14 gauge

**Finish:** G-185 galvanizing

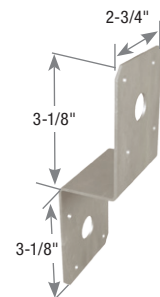
**Codes:** See page 12 for Code Reference Chart

**Installation:**

- Use all specified fasteners. See Product Notes, page 20.
- Use with 2x lumber for joists (minimum height is 2x4). Install with either specified nails or through bolts. Do not use lag bolts. To ease installation, attach to 4x4 post first.



Typical SDJT14-TZ installation



SDJT14-TZ

Post Size	MiTek USP Stock No.	Ref. No.	Steel Gauge	Fastener Schedule				DF/SP Allowable Loads (Lbs.)						Corrosion Finish	Code Ref.
				Nails <sup>2</sup>		Bolts <sup>1</sup>		Nails			Bolts				
				Qty	Type	Qty	Dia.	100%	115%	125%	100%	115%	125%		
4 x 4	SDJT14-TZ	DJT14Z	14	8	16d HDG	2	3/8 HDG	1120	1290	1400	1400	1400	1400		--

1) Bolts shall conform to ASTM A 307 or better.

2) **NAILS:** 16d HDG nails are 0.162" dia. x 3-1/2" long.

**Corrosion Finish** ■ Stainless Steel ■ Gold Coat ■ HDG ■ Triple Zinc

L / T – 14 gauge medium-capacity straps fasten with either nails or bolts.

LH / TH – 7 gauge heavy-capacity bolt-on strap.

**Materials:** See chart

**Finish:** G90 galvanizing; LH / TH – Primer; TH12-HDG – Hot-dip galvanized.

**Options:** See chart for Corrosion Finish Options. Available for special order in black primer coated finish.

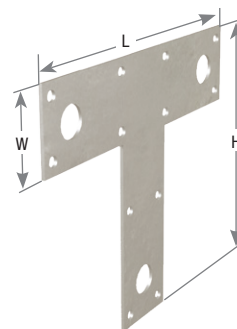
**Codes:** See page 12 for Code Reference Chart

**Installation:**

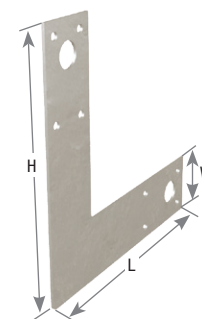
- Use all specified fasteners. See Product Notes, page 20.
- Straps are not load rated.

MiTek USP Stock No.	Ref. No.	Steel Gauge	Dimensions (in)			Fastener Schedule <sup>1,2</sup>				Corrosion Finish	Code Ref.
			W	H	L	Bolts		Nails			
						Qty	Dia.	Qty	Type		
T6	66T	14	1-1/2	5	6	3	1/2	12	16d		
T8	--	14	2	8	8-1/2	3	1/2	12	16d		
T12	128T	14	2	8	12	3	1/2	12	16d		
T1212	1212T	14	2	12	12	3	1/2	12	16d		
L6	66L	14	1-1/2	6	6	2	1/2	8	16d		
L8	88L	14	2	8	8	2	1/2	8	16d		
L12	1212L	14	2	12	12	3	1/2	12	16d		
TH12-HDG	1212HT, 1212HTHDG	7	2-1/2	12	12	6	5/8	--	--		
TH16	1616HT	7	2-1/2	16	16-1/4	6	5/8	--	--		
LH12	1212HL	7	3	12	12	5	5/8	--	--		
LH16	1616HL	7	2-1/2	16	16	7	5/8	--	--		

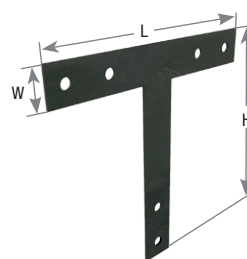
1) All bolts shall meet or exceed the specifications of ASTM A 307.  
 2) **NAILS:** 16d nails are 0.162" dia. x 3-1/2" long.



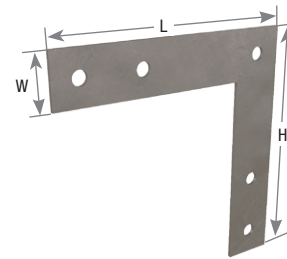
T6



L6



TH16



LH12

**Corrosion Finish**  
 ■ Stainless Steel ■ Gold Coat  
 ■ HDG ■ Triple Zinc

Angles & Straps

## Ornamental

Ornamental notching provides architectural appearance for exposed applications.

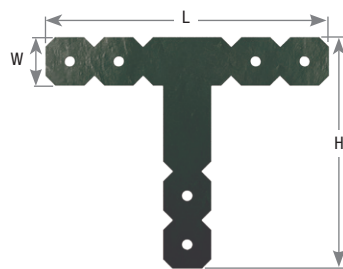
**Materials:** See chart

**Finish:** Black primer

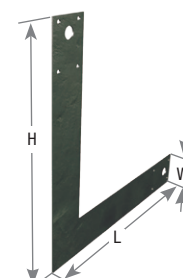
**Codes:** See page 12 for Code Reference Chart

**Installation:**

- Use all specified fasteners. See Product Notes, page 20.
- Connectors are not load rated.

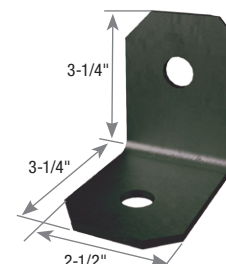


T1212-0



L12-0

Some model designs may vary from illustration shown



KHL33-0

MiTek USP Stock No.	Ref. No.	Steel Gauge	Description	Dimensions (in)			Bolt Schedule <sup>1</sup>		Code Ref.
				W	H	L	Qty	Dia.	
KHL33-0	OHA33	7	Heavy Angle	3-1/4	--	2-1/2	2	5/8	
KHL36-0	OHA36	7	Heavy Angle	3-1/4	--	6	4	5/8	
KHST64-0	OHS135	7	Strap Tie	6	--	13-1/2	4	3/4	
ST12-0	OS	12	Strap Tie	2	--	12	4	1/2	
L12-0	OL	12	'L' Strap	2-1/2	11-7/8	11-7/8	5	1/2	--
LH12-0	OHL	7	'L' Strap	2-1/2	11-7/8	11-7/8	5	5/8	
T1212-0	OT	12	'T' Strap	2-1/2	11-7/8	14-1/2	6	1/2	
TH12-0	OHT	7	'T' Strap	2-1/2	11-7/8	11-1/8	4	5/8	
TH16-0	--	7	'T' Strap	2-1/2	11-7/8	16-1/8	6	5/8	

1) All bolts shall meet or exceed the specifications of ASTM A 307.

Coiled strapping enables cut-to-length convenience for a variety of immediate job site needs.

**CMST** – 3" wide strapping features diamond nail holes to provide nailing options and reduce wood splitting.

**CMSTC** – 3" wide strapping is designed for high load conditions. Engineered to reduce wood splitting.

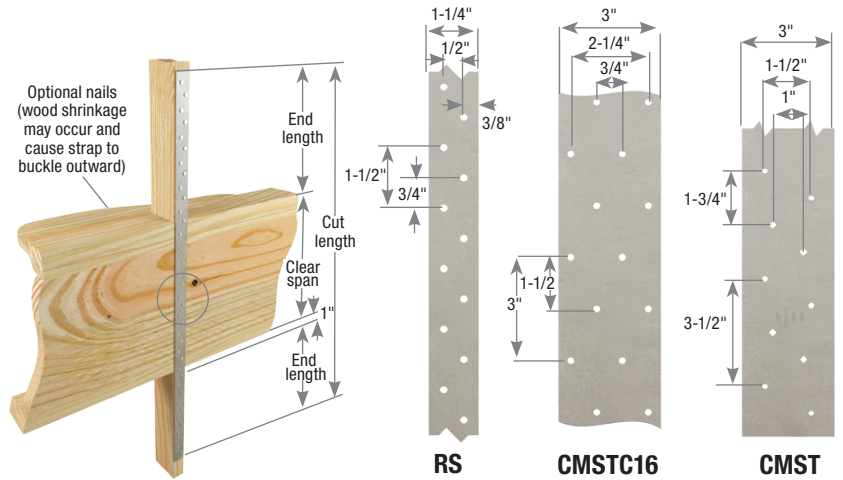
**RS** – 1-1/4" wide strapping packaged in cartons containing 25-foot or longer coils.

**Materials:** See chart

**Finish:** G90 galvanizing

**Options:** See chart for Corrosion Finish Options

**Codes:** See page 12 for Code Reference Chart



**Typical RS rim joist installation CMST similar**

**Installation:**

- Use all specified fasteners. See Product Notes, page 20.
- For safety, always wear gloves when handling or cutting coiled strapping.
- **CMST** installations: Install to a minimum 2-ply 2x edge. Increase nail spacing if wood begins to split.
- Designer may specify alternate nailing schedules. Refer to **Nail Specification Table** on page 23 for nail shear values. Load values shall not exceed published allowable loads.

MiTek USP Stock No.	Ref. No.	Steel Gauge	Coil Length	DF/SP					S-P-F / Hem Fir					Corrosion Finish	Code Ref.		
				Rim Joist Installation		Fastener Schedule <sup>3,4</sup>		Nail Spacing O.C.	Allowable Tension (Lbs.) <sup>1</sup> 160%	Rim Joist Installation		Fastener Schedule <sup>3,4</sup>				Nail Spacing O.C.	Allowable Tension (Lbs.) <sup>1</sup> 160%
				Cut Length	End Length	Min Qty. <sup>2</sup>	Type			Cut Length	End Length	Min Qty. <sup>2</sup>	Type				
CMSTC16	CMSTC16	16	54'	Clear Span + 46"	23"	60	10d	1-1/2"	4715	Clear Span + 58"	29"	74	10d	1-1/2"	4715		
				Clear Span + 90"	45"	60	10d	3"		Clear Span + 112"	56"	74	10d	3"			
				Clear Span + 40"	20"	50	16d	1-1/2"		Clear Span + 48"	24"	62	16d	1-1/2"			
				Clear Span + 76"	38"	50	16d	3"		Clear Span + 94"	47"	62	16d	3"			
CMST14	CMST14	14	52-1/2'	Clear Span + 58"	29"	64	16d	1-3/4"	6630	Clear Span + 72"	36"	80	16d	1-3/4"	6630		
				Clear Span + 130"	65"	74	10d	3-1/2"		Clear Span + 164"	82"	94	10d	3-1/2"			
				Clear Span + 256"	128"	74	10d	7"		Clear Span + 326"	163"	94	10d	7"			
CMST12	CMST12	12	40'	Clear Span + 74"	37"	82	16d	1-3/4"	9320	Clear Span + 90"	45"	102	16d	1-3/4"	9320		
				Clear Span + 168"	84"	96	10d	3-1/2"		Clear Span + 206"	103"	118	10d	3-1/2"			
				Clear Span + 332"	166"	96	10d	7"		Clear Span + 410"	205"	118	10d	7"			
RS300	--	22	300'	Clear Span + 12"	6"	12	10d	1-1/2"	925	Clear Span + 14"	7"	16	10d	1-1/2"	925		
RS22-R	--		25'			14	8d	1-1/2"		Clear Span + 16"	8"	18	8d	1-1/2"			
RS250	CS20	20	250'	Clear Span + 12"	6"	14	10d	1-1/2"	1045	Clear Span + 16"	8"	18	10d	1-1/2"	1045	IBC, FL, LA	
			RS20-R			CS20-R, CSHP20	25'	14		10d	1-1/2"	Clear Span + 16"	8"	18			10d
RS200	--	18	200'	Clear Span + 16"	8"	18	10d	1-1/2"	1375	Clear Span + 18"	9"	20	8d	1-1/2"	1375		
			RS100			CSHP18	100'	18		10d	1-1/2"	Clear Span + 18"	9"	22			10d
RS18-R	--	16	25'	Clear Span + 18"	9"	18	10d	1-1/2"	1730	Clear Span + 18"	9"	22	10d	1-1/2"	1730		
			RS150			CS16	150'	22		8d	1-1/2"	Clear Span + 22"	11"	26			8d
RS16-R	CS16-R	14	25'	Clear Span + 18"	9"	22	10d	1-1/2"	2610	Clear Span + 24"	12"	28	10d	1-1/2"	2610		
			RS14-100			CS14	100'	28		8d	1-1/2"	Clear Span + 26"	13"	32			8d
RS14-R	CS14-R	25'	25'	Clear Span + 24"	12"	28	10d	1-1/2"	2610	Clear Span + 30"	15"	36	10d	1-1/2"	2610		
				Clear Span + 28"	14"	34	8d	1-1/2"		Clear Span + 34"	17"	42	8d	1-1/2"			

1) Allowable loads have been increased 60% for wind or seismic loads; no further increase shall be permitted.  
 2) Minimum quantity of fasteners to be installed with equal fasteners at each end of the connection.  
 Product may have additional nail holes not needed to meet published allowable load of product.  
 3) 16d sinker nails may be substituted for 10d nails with no load reduction.  
 4) **NAILS:** 8d nails are 0.131" dia. x 2-1/2" long, 10d nails are 0.148" dia. x 3" long, 16d nails are 0.162" dia. x 3-1/2" long.

**Corrosion Finish**  
 ■ Stainless Steel ■ Gold Coat  
 ■ HDG ■ Triple Zinc

Copyright © 2018 MiTek Industries, Inc. All Rights Reserved

**HRS** – 12 gauge, 1-3/8" or 3-1/4" wide strapping.

**LSTA** – 20 or 18 gauge, light-capacity 1-1/4" wide strapping.

**LSTI** – 3-3/4" wide strap ties provide tension load path for truss top chords. The nail pattern accommodates open web trusses with double top chord.

**MSTA** – 18 or 16 gauge, medium-capacity 1-1/4" wide strapping.

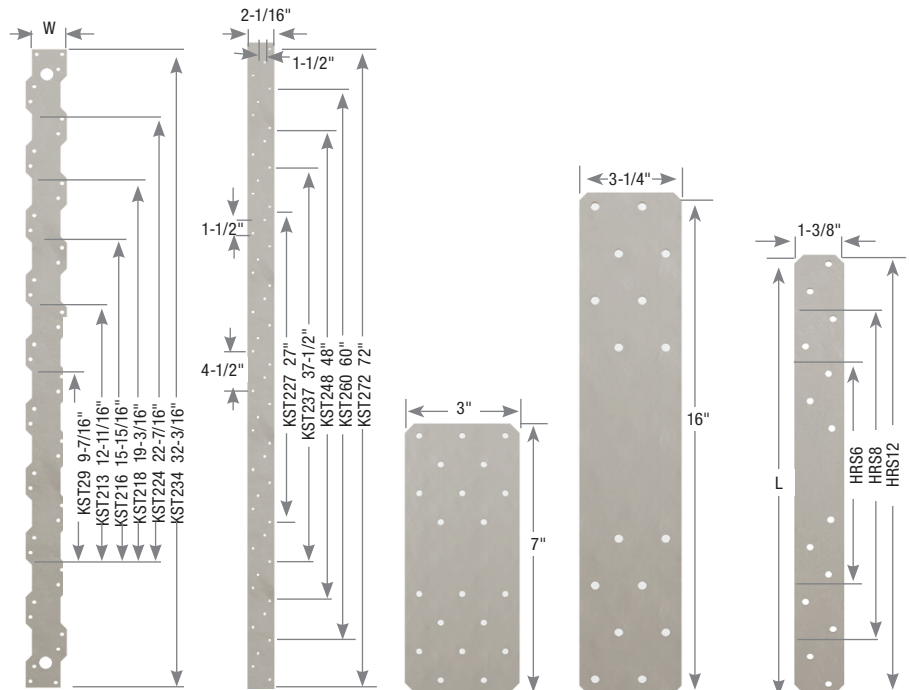
**HTP** – 16 gauge, medium-capacity 3" wide strapping.

**ST** – 16 gauge, medium-capacity 1-1/4" wide strapping.

**MSTC** – 3" wide strapping. Slotted hole design allows for higher load capacities and reduces splitting of lumber when attached to multiple 2x members.

**KST** – 3/4", 1-3/4", or 2-1/16" wide strapping. Straps can be fastened using either nails or bolts. Some KST straps install only with nails.

**KSTI** – 2-1/16" wide strapping. Straps are designed for installation to wood I-Joist flanges.



**KST**  
scalloped design

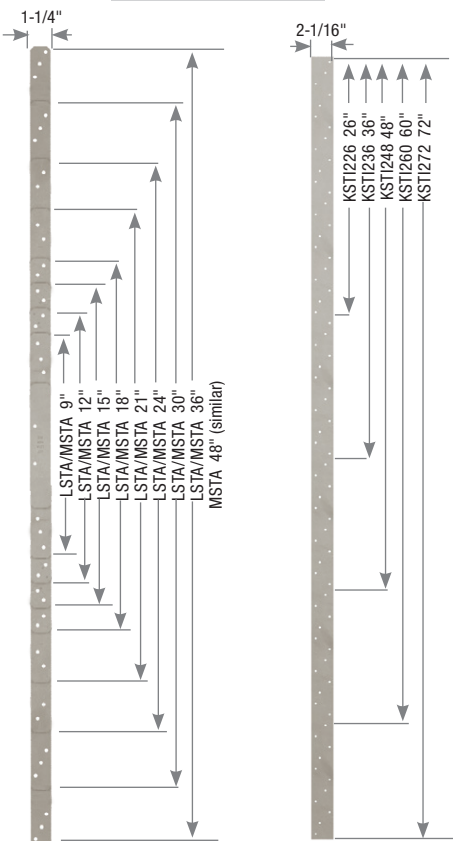
**KST**  
straight edge design

**HTP37-TZ**

**HRS416-TZ**

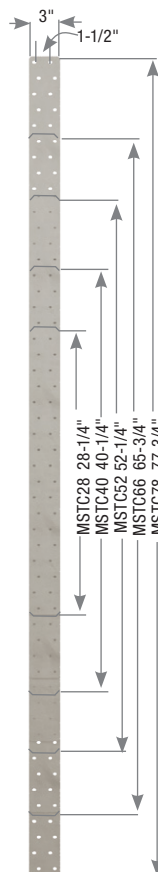
**HRS**

Some model designs may vary from illustration shown

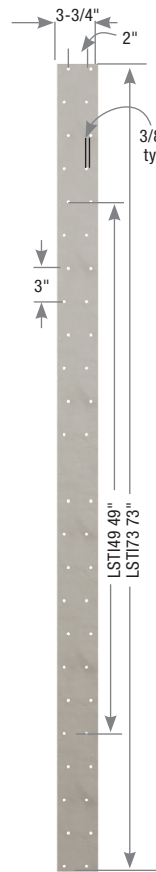


**LSTA/MSTA**

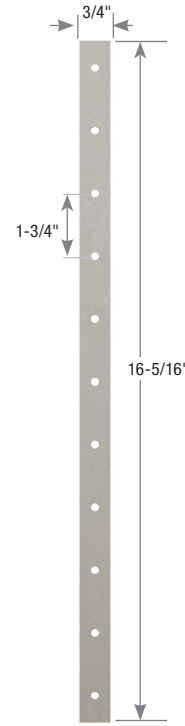
**KSTI**



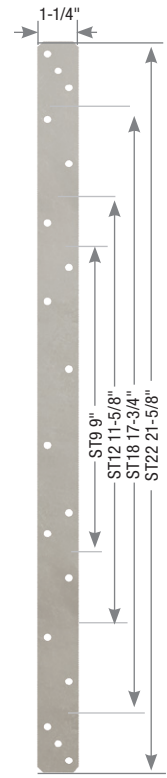
**MSTC**



**LSTI**



**KST116**



**ST**



**Materials:** See chart

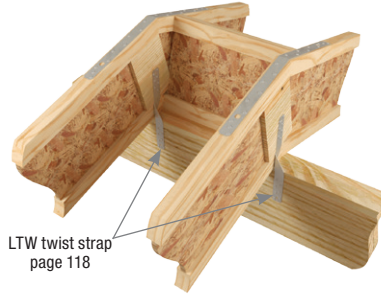
**Finish:** G90 galvanizing

**Options:** See chart for Corrosion Finish Options

**Codes:** See page 12 for Code Reference Chart

**Installation:**

- Use all specified fasteners. See Product Notes, page 20.
- Designer may specify alternate nailing schedules. Refer to **Nail Specification Table** on page 23 for nail shear values.
- The quantity of nails installed shall be equally distributed to both ends of the strap.



**Typical LSTA/MSTA I-Joist on ridge beam installation**



**Typical LSTI open web truss installation**

MiTek USP Stock No. <sup>4</sup>	Ref. No.	Steel Gauge	Dimensions (in)		Fastener Schedule <sup>5</sup>			DF/SP Allowable Tension Loads (Lbs.) <sup>1</sup>	S-P-F/HF Allowable Tension Loads (Lbs.) <sup>1</sup>	Corrosion Finish	Code Ref.
			W	L	Total Qty <sup>2</sup>	Min Qty <sup>3</sup>	Type	160%	160%		
KST116	ST2115	20	3/4	16-5/16	10	8	16d	665	665		
LSTA9	LSTA9	20	1-1/4	9	8	8	10d	740	635		
LSTA12	LSTA12	20	1-1/4	12	10	10	10d	930	790		
LSTA15	LSTA15	20	1-1/4	15	12	12	10d	1115	950		
LSTA18	LSTA18	20	1-1/4	18	14	14	10d	1235	1110		
LSTA21	LSTA21	20	1-1/4	21	16	16	10d	1235	1235		
LSTA24	LSTA24	20	1-1/4	24	18	16	10d	1235	1235		
KST29	ST292	20	1-3/4	9-7/16	14	14	16d	1545	1320		
KST213	ST2122	20	1-3/4	12-11/16	18	18	16d	1785	1700		
KST216	ST2215	20	1-3/4	15-15/16	22	18	16d	1785	1700		
LSTA30	LSTA30	18	1-1/4	30	22	22	10d	1640	1640		
LSTA36	LSTA36	18	1-1/4	36	26	22	10d	1640	1640		
MSTA9	MSTA9	18	1-1/4	9	8	8	10d	750	645		
MSTA12	MSTA12	18	1-1/4	12	10	10	10d	935	810		
MSTA15	MSTA15	18	1-1/4	15	12	12	10d	1125	970		
MSTA18	MSTA18	18	1-1/4	18	14	14	10d	1310	1130		
MSTA21	MSTA21	18	1-1/4	21	16	16	10d	1500	1295		
MSTA24	MSTA24	18	1-1/4	24	18	18	10d	1640	1455		
LSTI49	LSTI49	18	3-3/4	49	32	32	10d x 1-1/2	2970	2560		
LSTI73	LSTI73	18	3-3/4	73	48	48	10d x 1-1/2	4130	3840		
ST9	ST9	16	1-1/4	9	8	8	16d	895	775		
ST12	ST12	16	1-1/4	11-5/8	10	10	16d	1120	970		
ST18	ST18	16	1-1/4	17-3/4	14	14	16d	1570	1355		
ST22	ST22	16	1-1/4	21-5/8	18	18	16d	1705	1705		
MSTA30	MSTA30	16	1-1/4	30	22	22	10d	2065	1815		
MSTA36	MSTA36	16	1-1/4	36	26	26	10d	2065	2065		
MSTA48	MSTA49	16	1-1/4	48	32	26	10d	2045	2045		
KST218	ST6215	16	1-3/4	19-3/16	26	26	16d	2955	2540		
KST224	ST6224	16	1-3/4	22-7/16	30	30	16d	2960	2930		
HTP37-TZ	HTP37Z	16	3	7	20	20	10d x 1-1/2	1855	1600		--
MSTC28	MSTC28	16	3	28-1/4	36	36	10d	3455	2965		
					36	34	16d	3860	3320		
MSTC40	MSTC40	16	3	40-1/4	52	52	10d	4715	4285		
					52	46	16d	4715	4490		
MSTC52	MSTC52	16	3	52-1/4	70	60	10d	4715	4715		
					70	52	16d	4715	4715		
KST234	ST6236	14	1-3/4	32-3/16	42	36	16d	3775	3660		
MSTC66	MSTC66	14	3	65-3/4	88	72	10d	6015	6015		
					88	62	16d	6015	6015		
MSTC78	MSTC78	14	3	77-3/4	104	76	10d	6015	6015		
					104	66	16d	6015	6015		

1) Allowable loads have been increased 60% for wind or seismic loads; no further increase shall be permitted.  
 2) Total number of nail and/or bolt holes provided in the strap.  
 3) Minimum quantity of fasteners to be installed with equal fasteners at each end of the connection. Product may have additional nail holes not needed to meet published allowable load of product.  
 4) For MSTC straps: 16d sinker nails may be substituted for 10d nails with no reduction in load.  
 5) **NAILS:** 10d x 1-1/2 nails are 0.148"dia. x 1-1/2"long, 10d nails are 0.148"dia. x 3"long, 16d nails are 0.162"dia. x 3-1/2"long. New products or updated product information are designated in **blue font**.

**Corrosion Finish**  
 ■ Stainless Steel ■ Gold Coat  
 ■ HDG ■ Triple Zinc

MiTek USP Stock No.	Ref. No.	Steel Gauge	Dimensions (in)		Fastener Schedule <sup>6,7</sup>					DF/SP Allowable Tension Loads (Lbs.) <sup>1,2</sup>		S-P-F/HF Allowable Tension Loads (Lbs.) <sup>1,2</sup>		Corrosion Finish	Code Ref.
					W	L	Total Qty <sup>3</sup>	Min Qty <sup>4</sup>	Type	Min Qty <sup>4</sup>	Dia.	Nails			
			160%	160%								160%	160%		
HRS6	HRS6	12	1-3/8	6	6	6	10d	--	--	640	--	550	--		
HRS8	HRS8	12	1-3/8	8	10	10	10d	--	--	1065	--	920	--		--
HRS12	HRS12	12	1-3/8	12	14	14	10d	--	--	1490	--	1290	--		
KST227	MST27	12	2-1/16	27	34	34	16d	4	1/2	<b>4215</b>	<b>2190</b>	3645	2020		
KST237	MST37	12	2-1/16	37-1/2	48	48	16d	6	1/2	5140	<b>3105</b>	5140	2875		
KST248	MST48	12	2-1/16	48	62	54	16d	8	1/2	5140	<b>3825</b>	5140	3555		
KSTI226	MSTI26	12	2-1/16	26	26	26	10d x 1-1/2	--	--	<b>2765</b>	--	<b>2390</b>	--		
KSTI236	MSTI36	12	2-1/16	36	36	36	10d x 1-1/2	--	--	<b>3830</b>	--	<b>3310</b>	--		
KSTI248	MSTI48	12	2-1/16	48	48	48	10d x 1-1/2	--	--	5105	--	<b>4415</b>	--		IBC, FL, LA
KSTI260	MSTI60	12	2-1/16	60	60	60	10d x 1-1/2	--	--	5140	--	5140	--		
KSTI272	MSTI72	12	2-1/16	72	72	60	10d x 1-1/2	--	--	5140	--	5140	--		
HRS416-TZ	HRS416Z	12	3-1/4	16	16	16	WS15-EXT	--	--	2945	--	2410	--		--
KST260	MST60	10	2-1/16	60	72	64	16d	10	1/2	6720	<b>4695</b>	6720	<b>4425</b>		IBC, FL, LA
KST272	MST72	10	2-1/16	72	72	64	16d	10	1/2	6720	<b>4695</b>	6720	<b>4425</b>		

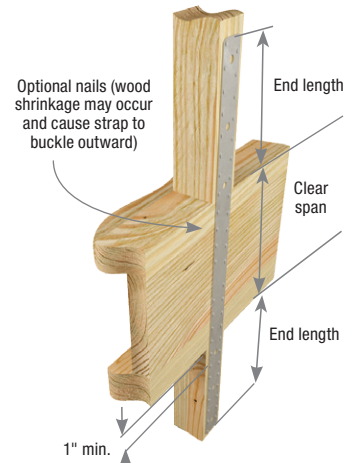
- 1) Allowable loads have been increased 60% for wind or seismic loads; no further increase shall be permitted.
- 2) Allowable loads are based on the use of either nails or bolts; nail and bolt values cannot be combined.
- 3) Total number of nail and/or bolt holes provided in the strap.
- 4) Minimum quantity of fasteners to be installed with equal fasteners at each end of the connection. Product may have additional nail holes not needed to meet published allowable load of product.
- 5) Allowable bolt loads are based on parallel-to-grain loading, minimum of 2-1/2" thick.
- 6) WS15-EXT Wood Screws are 1/4" dia. x 1-1/2" long.
- 7) **NAILS:** 10d x 1-1/2 nails are 0.148" dia. x 1-1/2" long, 10d nails are 0.148" dia. x 3" long, 16d nails are 0.162" dia. x 3-1/2" long. New products or updated product information are designated in **blue font**.

Corrosion Finish ■ Stainless Steel ■ Gold Coat ■ HDG ■ Triple Zinc

Clear Span Chart

MiTek USP Stock No.	Ref. No.	Clear Span	10d x 1-1/2" Fasteners <sup>3</sup>		10d Fasteners <sup>3</sup>		16d Fasteners <sup>3</sup>	
			Total <sup>2</sup> Qty	DF/SP	Total <sup>2</sup> Qty	DF/SP	Total <sup>2</sup> Qty	DF/SP
				Tension 160% <sup>1</sup>		Tension 160% <sup>1</sup>		Tension 160% <sup>1</sup>
MSTC28	MSTC28	18			12	1150	12	1365
		16			16	1535	14	1590
MSTC40	MSTC40	18			28	2690	24	2725
		16			32	3070	30	3410
MSTC52	MSTC52	18	--	--	44	4225	38	4315
		16			48	4610	42	4715
MSTC66	MSTC66	18			62	6015	54	6015
		16			64	6015	54	6015
MSTC78	MSTC78	18			64	6015	54	6015
		16			66	6015	56	6015
KST237	MST37	18					20	2480
		16					22	2730
KST248	MST48	18					32	3970
		16					34	4215
KST260	MST60	18					46	6255
		16					48	6530
KST272	MST72	18					46	6255
		16					48	6530
KSTI236	MSTI36	18	14	1410				
		16	16	1615				
KSTI248	MSTI48	18	26	2620				
		16	28	2820				
KSTI260	MSTI60	18	38	3830	--	--	--	--
		16	40	4030				
KSTI272	MSTI72	18	50	5040				
		16	52	5240				

- 1) Allowable loads have been increased 60% for wind or seismic loads; no further increase shall be permitted.
- 2) Total number of nail holes provided in the strap.
- 3) **NAILS:** 10d x 1-1/2 nails are 0.148" dia. x 1-1/2" long, 10d nails are 0.148" dia. x 3" long, 16d nails are 0.162" dia. x 3-1/2" long.



Typical KST237 floor-to-floor installation

**KRPS** – Meets IBC, IRC, & L.A. City requirements for notched plates where pipes placed in partitions.

**PS** – Piling Straps connect wood pilings to floor girders. Hot-dip galvanized for corrosion protection in coastal environments.

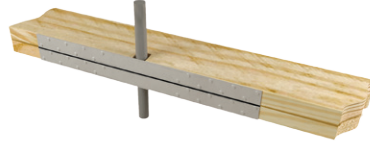
**KHST** – Heavy-capacity strap that utilizes bolts.

**Materials:** See chart

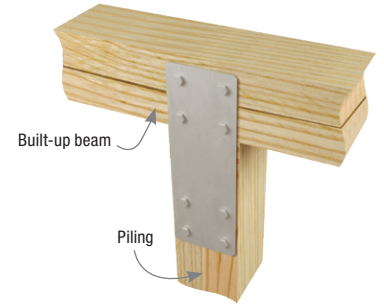
**Finish:** KHST – Primer; KRPS – G90 galvanizing; PS – Hot-dip galvanized

**Options:** See chart for Corrosion Finish Options

**Codes:** See page 12 for Code Reference Chart  
IRC R602.6.1, IBC 2308.9.8 (2015), IBC 2308.5.8 (2015)



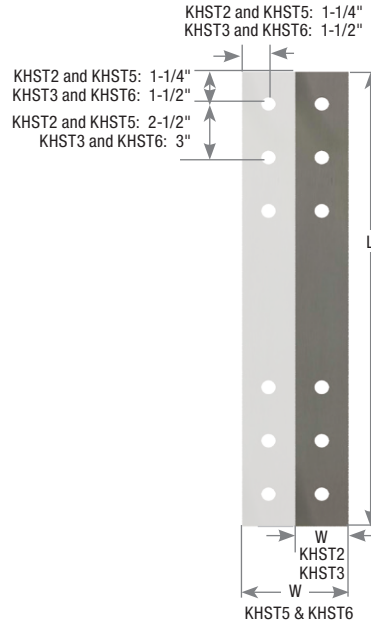
Typical KRPS installation



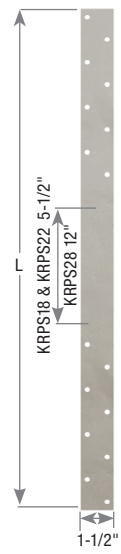
Typical PS720-HDG installation

**Installation:**

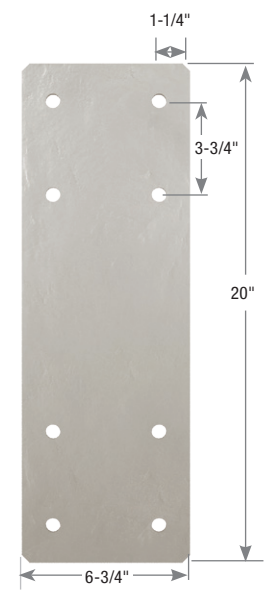
- Use all specified fasteners. See Product Notes, page 20.
- Install one strap tie for each 2x plate.



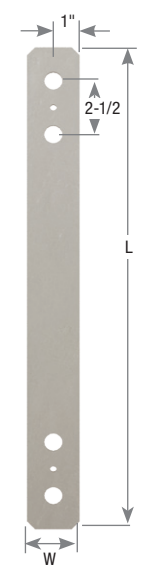
**KHST**



**KRPS**



**PS720-HDG**



**PS218-HDG**  
**PS418-HDG similar**

MiTek USP Stock No. <sup>3</sup>	Ref. No.	Steel Gauge	Dimensions (in)		Notch Width (in)	Fastener Schedule <sup>4</sup>				DF/SP Allowable Loads (Lbs.) <sup>1,2</sup>	Corrosion Finish	Code Ref.
			W	L		Nails		Bolts				
						Qty	Type	Qty	Type			
KHST2	HST2	7	2-1/2	21-1/4	--	--	--	6	5/8	5345		IBC, FL, LA
KHST3	HST3	3	3	25-1/2	--	--	--	6	3/4	7920		
KHST5	HST5	7	5	21-1/4	--	--	--	12	5/8	10825		
KHST6	HST6	3	6	25-1/2	--	--	--	12	3/4	15935		
PS218-HDG	PS218	7	2	18	--	--	--	4	5/8	--		--
PS418-HDG	PS418	7	4	18	--	--	--	4	5/8	--		--
PS720-HDG	PS720	7	6-3/4	20	--	--	--	8	5/8	--		--
KRPS18	RPS18	16	1-1/2	18-5/16	≤ 5-1/2	12	16d	--	--	1345		IBC, FL, LA
KRPS22	RPS22	16	1-1/2	22-5/16	≤ 5-1/2	12	16d	--	--	1345		--
						16				1790		IBC, FL, LA
KRPS28	RPS28	16	1-1/2	28-5/16	≤ 12	12	16d	--	--	1345		--
						16				1790		IBC, FL, LA

1) Allowable loads have been increased 60% for wind or seismic loads; no further increase shall be permitted.  
 2) Allowable loads are based on single shear, parallel to grain loading with a 3-1/2" minimum member thickness for KHST2 and KHST5, and 4-1/2" minimum member thickness for KHST3 and KHST6.  
 3) PS piling strap design loads must be determined for each installation. Bolts are installed perpendicular and parallel-to-grain.  
 4) **NAILS:** 16d nails are 0.162" dia. x 3-1/2" long.

**Corrosion Finish** ■ Stainless Steel ■ Gold Coat ■ HDG ■ Triple Zinc

# HFS Compression & Tension Straps



The HFS Hardy Frame® Saddle is a 14 gauge steel channel intended to be used as a splice at locations where plumbing or other vertical penetrations destroy the structural integrity of a wall's top plates.

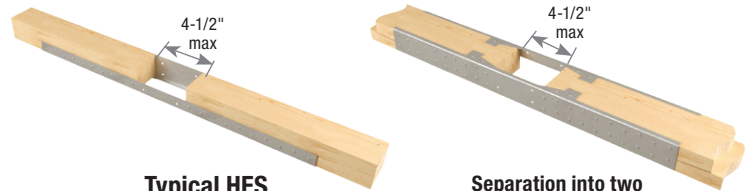
**Materials:** 14 gauge

**Finish:** G60 galvanizing

**Codes:** See page 12 for Code Reference Chart

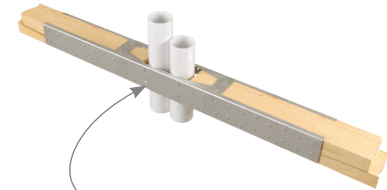
**Installation:**

- Use all specified fasteners. See Product Notes, page 20.
- The Saddle can be installed over the top or from the underside of the top plates, and is capable of resisting both tension and compression loads in a clearspan of up to 4-1/2".
- For wall depths greater than 3-1/2", or to install after plumbing lines have been run, the product can be separated into two "L" shapes by gripping the legs of the channel and flexing the top surface along the serration lines.



Typical HFS installation to underside of double top plates.

Separation into two "L" shapes at 6" and greater depths



Omit fasteners at first holes when the end distance is less than 1"

MiTek USP Stock No.	Ref. No.	Steel Gauge	Dimensions (in)		Notch Width	Fastener Schedule		DF/SP Allowable Loads (Lbs.) <sup>1,3</sup>		S-P-F Allowable Loads (Lbs.) <sup>1,3</sup>		Code Ref.
			W	L		Qty <sup>2</sup>	Type <sup>4</sup>	Tension 100%	Compression 100%	Tension 100%	Compression 100%	
HFS24	--	14	3-5/8	24	≤ 4-1/2	24	16d	2950	2500	2537	2500	IBC, LA
HFS36	--	14	3-5/8	36	≤ 4-1/2	32	16d	4280	2500	3681	2500	LA

- 1) Allowable tension loads are for normal duration. The values may be adjusted for other durations, such as for seismic and wind loading in accordance with the AF&PA NDS.
- 2) Fastener quantity is the number of 16d common nails to be installed into each of the members to be joined. When the end distance from the joint to the first nail hole is less than 1", omit the (2) nails in the 3"ch side-plate and the (1) nail in the 1-1/2" side-plate that are nearest the joint.
- 3) There is no reduction in double top plate capacity provided the HFS24 is installed with minimum (22) 16d common nails in each member being joined (44 total) and the HFS36 is installed with (31) 16d common nails in each member (62 total).
- 4) **NAILS:** 16d nails are 0.162" dia. x 3-1/2" long.

Angles & Straps

# MSTCB Pre-Bent Straps

The MSTCB Pre-Bent Strap is designed to fasten vertical studs to a beam or ridge beam member below where the beam depth will not allow complete fastener attachments with a standard product.

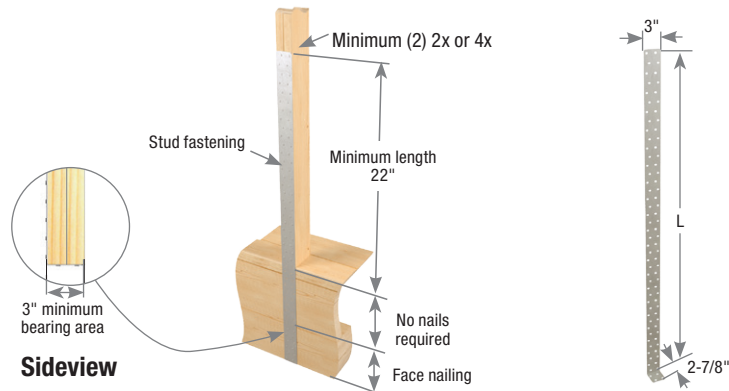
**Materials:** 14 gauge

**Finish:** G90 galvanizing

**Codes:** See page 12 for Code Reference Chart

**Installation:**

- Use all specified fasteners. See Product Notes, page 20.



Typical MSTC66B3 installation

MSTCB

MiTek USP Stock No.	Ref. No.	Ga	L (in)	Min. Beam Dimensions (in)		Fastener Schedule <sup>5</sup>			Stud/Post <sup>2,3,4</sup>	DF/SP Allowable Loads (Lbs.) <sup>1</sup>	S-P-F Allowable Loads (Lbs.) <sup>1</sup>	Code Ref.	
				W	D	Beam		Qty					Type
				Face Qty	Bottom Qty	Type	Type						
MSTC48B3	MSTC48B3	14	44-7/8	3	9-1/4	12	4	10d	24	10d	4800	3905	--
MSTC66B3	MSTC66B3	14	62-7/8	3	11-1/4	14	4	10d	28	10d	5375	4250	--

- 1) Allowable loads have been increased 60% for wind or seismic loads; no further increase shall be permitted.
- 2) The 3" wide beam may be double for 2x members.
- 3) Fewer fasteners in the stud/post than listed will reduce the capacity of the connection.
- 4) Nails in the stud/post to be installed symmetrically in pairs starting a minimum of 1-1/2" from the end.
- 5) **NAILS:** 10d nails are 0.148" dia. x 3" long.

Copyright © 2018 MiTek Industries, Inc. All Rights Reserved

Twist straps tie framing members to resist tension forces.

**LFTA6** – 16 gauge.

**LTW** – 18 gauge, light-capacity.

**MTW** – 16 gauge, medium-capacity.

**KTS** – 16 gauge, medium-capacity with angled twist.

**HTW** – 14 gauge, heavy-capacity.

**Materials:** See chart

**Finish:** G90 galvanizing

**Options:** See chart for Corrosion Finish Options

**Codes:** See page 12 for Code Reference Chart

**Installation:**

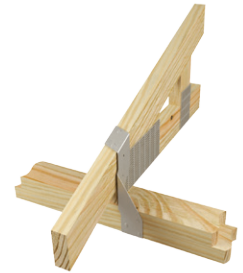
- Use all specified fasteners. See Product Notes, page 20.
- Consult I-Joist manufacturer for web stiffener requirements, and uplift limitations on joist and application.



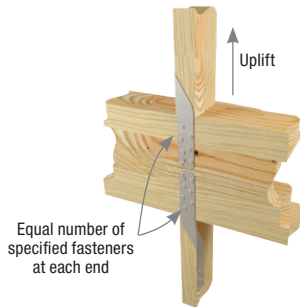
**Typical LTW12 / MTW12 truss-to-top plate installation**



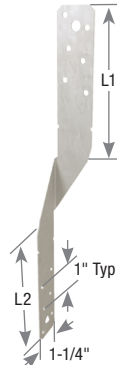
**Typical LFTA6 stud-to-top plate installation**



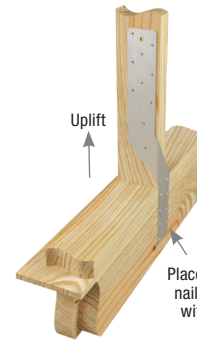
**Typical LFTA6 truss-to-top plate installation**



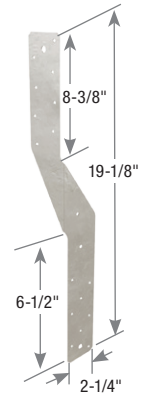
**Typical LTW12 / MTW12 stud-to-rim joist installation**



**LTW12/MTW12**



**Typical LFTA6 stud-to-rim joist installation**



**LFTA6**



**Typical MTW20 I-joist rafter installation**



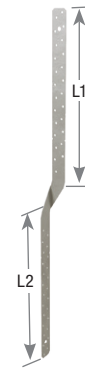
**LTW18/MTW18 other models similar**



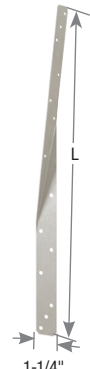
**Typical MTW30 installation**



**MTW30/HTW30**



**MTW30C**



**KTS**

MiTek USP Stock No. <sup>4</sup>	Ref. No.	Steel Gauge	Dimensions (in)				Fastener Schedule <sup>2,3,6</sup>		DF/SP Allowable Loads (Lbs.) <sup>1</sup>		S-P-F Allowable Loads (Lbs.) <sup>1</sup>		Corrosion Finish	Code Ref.					
			W	L	L1	L2	Qty	Type	Uplift 160% <sup>1</sup>		Uplift 160% <sup>1</sup>								
									Stud-to-Rim Joist Installation	Truss-to-Top Plate Installation	Stud-to-Rim Joist Installation	Truss-to-Top Plate Installation							
LTW12	LTS12	18	1-1/4	12	4-1/2	4-1/2	12	10d x 1-1/2	780	625	655	525	Blue	IBC, FL, LA					
							12	10d											
LTW16	LTS16	18	1-1/4	16	6-1/2	6-1/2	12	10d x 1-1/2	780	625	655	525	Blue		IBC, FL, LA				
							12	10d											
LTW18	LTS18	18	1-1/4	18	7-1/2	7-1/2	12	10d x 1-1/2	780	625	655	525	Blue			IBC, FL, LA			
							12	10d											
LTW20	LTS20	18	1-1/4	20	8-1/2	8-1/2	12	10d x 1-1/2	780	625	655	525	Blue				IBC, FL, LA		
							12	10d											
KTS9	TS9	16	1-1/4	9	--	--	8	16d	785	785	660	660	Blue					--	
KTS12	TS12	16	1-1/4	11-1/2	--	--	10	16d	1065	1065	895	895	Blue					--	
MTW12	MTS12	16	1-1/4	12	4-1/2	4-1/2	14	10d x 1-1/2	1185	980	995	820	Green					IBC, FL, LA	
							14	10d											
MTW16	MTS16	16	1-1/4	16	6-1/2	6-1/2	14	10d x 1-1/2	1185	980	995	820	Green	IBC, FL, LA					
							14	10d											
KTS17	TS18	16	1-1/4	17-1/2	--	--	14	16d	1100	1100	925	925	Blue		--				
MTW18	MTS18	16	1-1/4	18	7-1/2	7-1/2	14	10d x 1-1/2	1185	980	995	820	Green		IBC, FL, LA				
							14	10d											
LFTA6 <sup>5</sup>	H6	16	2-1/4	19-1/8	8-3/8	6-1/2	16	8d	980	980	825	825	Green			IBC, FL, LA			
							16	8d x 1-1/2											
MTW20	MTS20	16	1-1/4	20	8-1/2	8-1/2	14	10d x 1-1/2	1185	980	995	820	Green				IBC, FL, LA		
							14	10d											
KTS24	TS22	16	1-1/4	21-3/4	--	--	18	16d	1650	1650	1385	1385	Blue						--
MTW24C	MTS24C	16	1-1/4	24	10-7/16	10-7/16	14	10d x 1-1/2	1185	980	995	820	Green					IBC, FL, LA	
							14	10d											
MTW28C	--	16	1-1/4	28	12-7/16	12-7/16	14	10d x 1-1/2	1185	980	995	820	Green	IBC, FL, LA					
							14	10d											
MTW30	MTS30	16	1-1/4	30	8-5/16	18-9/16	14	10d x 1-1/2	1185	980	995	820	Green						IBC, FL, LA
							14	10d											
MTW30C	MTS30C	16	1-1/4	30	13-7/16	13-7/16	14	10d x 1-1/2	1185	980	995	820	Green		IBC, FL, LA				
							14	10d											
HTW16	HTS16	14	1-1/4	16	5-1/8	5-1/8	16	10d x 1-1/2	1115	1365	940	1145	Green			IBC, FL, LA			
							16	10d	1315		1105								
HTW20	HTS20	14	1-1/4	20	7-1/8	7-1/8	24	10d x 1-1/2	1555	1365	1305	1145	Green				IBC, FL, LA		
							20	10d	1355		1140								
HTW24	HTS24	14	1-1/4	24	9-1/8	9-1/8	24	10d x 1-1/2	1555	1365	1305	1145	Green					IBC, FL, LA	
							20	10d	1355		1140								
HTW28	--	14	1-1/4	28	11-1/8	11-1/8	24	10d x 1-1/2	1555	1365	1305	1145	Green	IBC, FL, LA					
							20	10d	1355		1140								
HTW30	HTS30	14	1-1/4	30	7	17-1/4	24	10d x 1-1/2	1555	1365	1305	1145	Green						IBC, FL, LA
							20	10d	1355		1140								
HTW30C	HTS30C	14	1-1/4	30	12-1/8	12-1/8	24	10d x 1-1/2	1555	1365	1305	1145	Green		IBC, FL, LA				
							20	10d	1355		1140								

1) Allowable loads have been increased 60% for wind or seismic loads; no further increase shall be permitted.  
 2) 16d sinker nails may be substituted for 10d common nails with no reduction in load.  
 3) Fasteners shall be distributed equally on each end of the connection.  
 4) C after the model number designates center twist as in MTW30C.  
 5) LFTA6: F1 is 745 lbs and F2 is 120 lbs. To achieve F1 lateral loads, three nails must be installed on each side on the strap located closest to the bend line. Lateral F1 and F2 load directions do not apply to roof truss-to-top plate installations.  
 6) NAILS: 8d x 1-1/2 nails are 0.131" dia. x 1-1/2" long, 8d nails are 0.131" dia. x 2-1/2" long, 10d x 1-1/2 nails are 0.148" dia. x 1-1/2" long, 10d nails are 0.148" dia. x 3" long, 16d nails are 0.162" dia. x 3-1/2" long.  
 New products or updated product information are designated in **blue font**.

**Corrosion Finish**  
 Blue Stainless Steel  
 Orange Gold Coat  
 Grey HDG  
 Green Triple Zinc

The MSTAM and MSTCM Strap Ties are designed to connect a wood structure above to a masonry wall below.

**Materials:** See chart

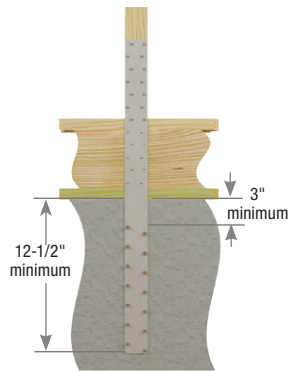
**Finish:** G90 galvanizing

**Options:** See chart for Corrosion Finish Options

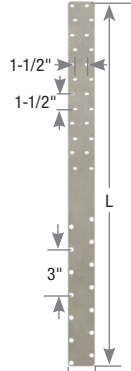
**Codes:** See page 12 for Code Reference Chart

**Installation:**

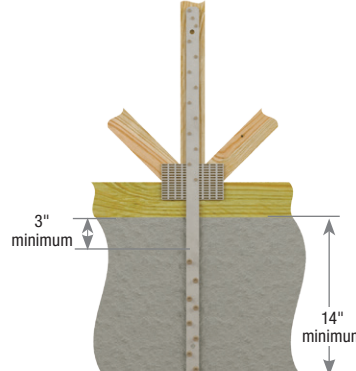
- Use all specified fasteners. See Product Notes, page 20.



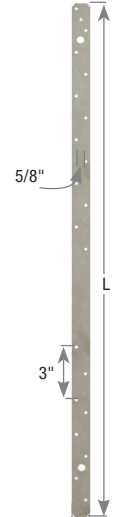
**Typical MSTCM40 installation**



**MSTCM40**



**Typical MSTAM36 installation**



**MSTAM36**

MiTek USP Stock No.	Ref. No.	Steel Gauge	Dimensions (in)		Fastener Schedule				DF/SP Allowable Tension Loads (Lbs.) <sup>1,2</sup>	S-P-F Allowable Tension Loads (Lbs.) <sup>1,2</sup>	Corrosion Finish	Code Ref.		
			W	L	CMU <sup>3</sup>		Concrete <sup>3</sup>						Nails <sup>4</sup>	
					Qty	Type	Qty	Type	Qty	Type			160%	160%
MSTAM24	MSTAM24	18	1-1/4	24	5	1/4" Tapcon	5	1/4" Tapcon	9	10d	1545	1455		
MSTAM36	MSTAM36	16	1-1/4	36	8	1/4" Tapcon	8	1/4" Tapcon	13	10d	1945	1945		
MSTCM40	MSTCM40	16	3	40-1/4	14	1/4" Tapcon	14	1/4" Tapcon	24 20	10d 16d	3665	3665		FL
MSTCM60	MSTCM60	16	3	60	14	1/4" Tapcon	14	1/4" Tapcon	24 20	10d 16d	3665	3665		

- 1) Allowable loads have been increased 60% for wind or seismic loads; no further increase shall be permitted.
- 2) Allowable loads are derived from tests performed using hollow C90 concrete block.
- 3) Use ITW Buildex 1/4" x 2-1/4" Tapcon fasteners; or equal, installed in accordance with manufacturer's specification.
- 4) **NAILS:** 10d nails are 0.148" dia. x 3" long, 16d nails are 0.162" dia. x 3-1/2" long.

**Corrosion Finish**

■	Stainless Steel
■	Gold Coat
■	HDG
■	Triple Zinc

**Clear Span Chart**

MiTek USP Stock No.	Clear Span	Fastener Schedule						DF/SP Allowable Tension Loads (Lbs.) <sup>2</sup>	S-P-F Allowable Tension Loads (Lbs.) <sup>2</sup>
		CMU <sup>1</sup>		Concrete <sup>1</sup>		Nails <sup>3</sup>			
		Qty	Type	Qty	Type	Qty	Type	Tension 160%	Tension 160%
MSTAM36	16	5	1/4" Tapcon	5	1/4" Tapcon	8	10d	1305	1305
	18	5	1/4" Tapcon	5	1/4" Tapcon	7	10d	1305	1155
MSTCM40	16	12	1/4" Tapcon	12	1/4" Tapcon	16	16d	3135	3125
	18	12	1/4" Tapcon	12	1/4" Tapcon	14	16d	3135	2735
MSTCM60	16	14	1/4" Tapcon	12	1/4" Tapcon	20	16d	3660	3660
	18	14	1/4" Tapcon	12	1/4" Tapcon	20	16d	3660	3660

- 1) Use ITW Buildex 1/4" x 2-1/4" Tapcon fasteners; or equal, installed in accordance with manufacturer's specification.
- 2) Allowable loads are derived from tests performed using hollow C90 concrete block.
- 3) **NAILS:** 10d nails are 0.148" dia. x 3" long, 16d nails are 0.162" dia. x 3-1/2" long.

Copyright © 2018 MiTek Industries, Inc. All Rights Reserved

Angles & Straps

The HTWM Twist Straps are designed for truss to concrete or masonry connections. Offers uplift resistance with variable heel height and positioning applications.

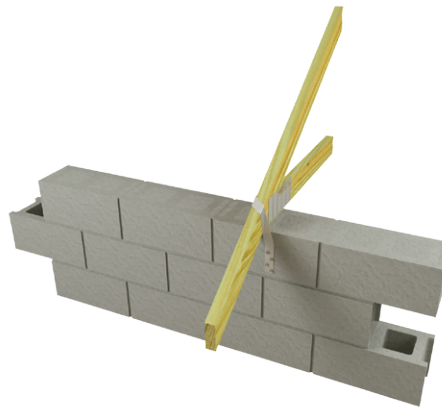
**Materials:** 14 gauge

**Finish:** G90 galvanizing

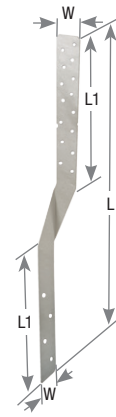
**Codes:** See page 12 for Code Reference Chart

**Installation:**

- Use all specified fasteners. See Product Notes, pages 20.
- Strap may be attached to either side of grouted masonry or concrete wall with a minimum of (1) #5 horizontal rebar.
- Drill hole in concrete or masonry with manufacturer's prescribed 1/4" masonry drill. Install fasteners into concrete or masonry per manufacturer's specification.
- Twist straps do not have to be wrapped over the truss to achieve the allowable loads.
- **Moisture barrier may be required.**



Typical HTWM installation



HTWM

MiTek USP Stock No.	Ref. No.	Steel Gauge	Dimensions (in)			Fastener Schedule				DF/SP Allowable Loads (Lbs.)	S-P-F Allowable Loads (Lbs.)	Code Ref.
			W	L	L1	CMU/Concrete Wall <sup>4</sup>		Truss/Rafter				
						Qty	Screw Anchor <sup>2,3</sup>	Qty	Type <sup>5</sup>	Uplift 160% <sup>1</sup>	Uplift 160% <sup>1</sup>	
HTWM16	HTSM16, MTSM16	14	1-1/4	16	5-3/4	4	1/4" x 1-3/4"	8	10d x 1-1/2	1225	1145	FL
HTWM20	HTSM20, MTSM20	14	1-1/4	20	7-3/4	4	1/4" x 1-3/4"	8	10d x 1-1/2	1225	1145	

- 1) Allowable loads have been increased 60% for wind or seismic loads; no further increase shall be permitted.
- 2) Use DeWalt 1/4" x 1-3/4" Screw-Bolt™+; or equal, installed in accordance with manufacturer's specification.
- 3) DeWalt 1/4" x 1-3/4" Screw-Bolt™+ are not supplied with HTWM straps. See page 46 for anchor information.
- 4) Grout or concrete compressive strength shall be 2,500 psi or greater at 28 days.
- 5) **NAILS:** 10d x 1-1/2 nails are 0.148" dia. x 1-1/2" long.

Angles & Straps

## KHSA / KSA Connector Straps

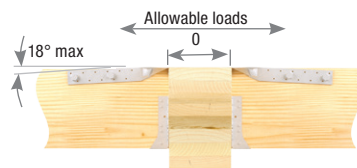
**KSA** – 12 gauge seismic horizontal tension tie.

**KHSA** – 3 gauge. Designed for installation with bolts only.

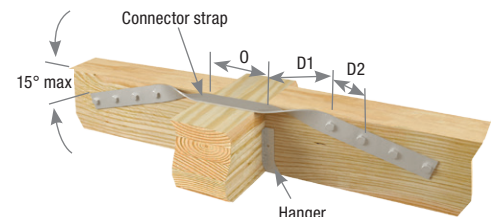
**Materials:** See chart

**Finish:** KSA – G90 galvanizing;  
KHSA – Primer

**Codes:** See page 12 for Code Reference Chart



Typical KSA installation



Typical KHSA4 installation



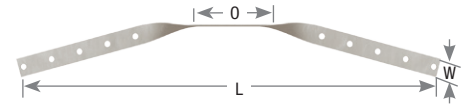
Typical KSA installation

Copyright © 2018 MiTek Industries, Inc. All Rights Reserved





**KSA36**



**KHSA5**

**Installation:**

- Use all specified fasteners. See Product Notes, page 20.
- KSA36 can be field adjusted for smaller beam widths.

MiTek USP Stock No.	Ref. No.	Steel Gauge	Dimensions (in)					Fastener Schedule <sup>3,4</sup>		DF/SP Allowable Tension Loads (Lbs.) <sup>1,2</sup>			Code Ref.
			W	L	0	D1	D2	Qty	Type	160%			
KSA36	SA36	12	2-1/16	37-7/8	9	6-11/16	4-1/2	22	16d	2620			IBC, FL, LA
								4	1/2	2015			
KHSA1	--	3	3	30	9	10	--	2	3/4	2435			
KHSA2	--	3	3	38-1/2	9	10	4-1/2	4	3/4	4810			
KHSA3	--	3	3	47	9	10	4-1/2	6	3/4	7005			
KHSA4	--	3	3	56	9	10	4-1/2	8	3/4	8920			
KHSA5	--	3	3-1/2	64-1/2	9	10	4-1/2	10	3/4	10785			

- 1) Allowable loads are based on the use of either nails or bolts; nail and bolt values cannot be combined.
- 2) Bolt values assume wood member thickness of 3-1/2" with bolts in single shear.
- 3) Bolts shall be loaded parallel to grain.
- 4) **NAILS:** 16d nails are 0.162" dia. x 3-1/2" long.

**KVB / KVBI** Knee Braces

**KVB** – Installs with WS3 wood screws for higher load capacity. It can be retrofit into existing framing.

**KVBI** – Installs with common nails. Designed to be used with I-Joist purlins.

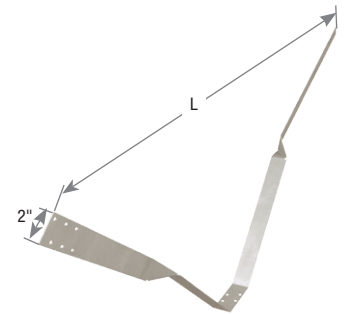
- Materials:** 12 gauge  
**Finish:** G90 galvanizing  
**Codes:** See page 12 for Code Reference Chart

**Installation:**

- Use all specified fasteners. See Product Notes, page 20.
- WS3 wood screws are included with KVB shipments.
- Install flanges at angles of 45° or more to the vertical plane to assure proper lateral resistance.



**Typical KVB7 installation**



**KVB5**

MiTek USP Stock No.	Ref. No.	Steel Gauge	Dimensions (in)		Fastener Schedule <sup>1,2</sup>				DF/SP Allowable Tension Loads (Lbs.)			Code Ref.
			Beam Depth	L	Beam		Joist		100%	125%	160%	
					Qty	Type	Qty	Type				
KVB5	VB5	12	10 - 15	60	4	WS3	12	WS3	1920	1920	1920	IBC, FL, LA
KVB7	VB7	12	15 - 22-1/2	84	4	WS3	12	WS3	1920	1920	1920	
KVB8	VB8	12	22-1/2 - 28-1/2	96	4	WS3	12	WS3	1920	1920	1920	
KVB10	VB10	12	28-1/2 - 36	120	4	WS3	12	WS3	1920	1920	1920	
KVB12	VB12	12	36 - 42	144	4	WS3	12	WS3	1920	1920	1920	
KVBI5	--	12	10 - 15	60	4	10d	12	10d	895	1060	1275	
KVBI7	--	12	15 - 22-1/2	84	6	10d	12	10d	895	1060	1275	
KVBI8	--	12	22-1/2 - 28-1/2	96	6	10d	12	10d	895	1060	1275	
KVBI10	--	12	28-1/2 - 36	120	6	10d	12	10d	895	1060	1275	
KVBI12	--	12	36 - 42	144	6	10d	12	10d	895	1060	1275	

- 1) WS3 Wood Screws are 1/4" x 3" long and are included with specified KVB models.
- 2) **NAILS:** 10d nails are 0.148" dia. x 3" long.

Copyright © 2018 MiTek Industries, Inc. All Rights Reserved

Hanger Selector Guide

Hanger Type	MiTek USP Series	Steel Gauge	Style		Supporting / Header Member								Supported / Joist Member						Allowable Loads (Lbs.) Range		MiTek USP Series Catalog Page Reference	
			Formed	Welded	Beam/Joist/Rafter (rect shapes)	I-Joist	Truss (2x)	Floor Truss 4x	Nailer	Glulam	Wall	Post	Rim Joist	Beam/Joist/Rafter (rect shapes)	I-Joist	Truss (2x)	Floor Truss 4x	Glulam	Stringer	Header Material		
																				Masonry 100%		DF/SP 100%
Face Mount	JL	20	•		•				•					•						--	470 - 1,930	123, 126-127, 138-139
	FB	18	•											•						--	315 - 330	153
	JUS	18	•		•				•					•	•	•	•			--	675 - 2,420	124, 126-134, 138-146
	CSH	18	•		•									•	•				•	--	890	154
	MUS	18	•		•					•				•	•	•	•	•		--	1,285 - 1,710	124, 126-127, 138-139
	JLIF	18	•		•									•	•					--	465 - 1,520	123, 126-127, 138-139
	SUH	16	•		•					•					•	•				--	500 - 2,645	123, 126-135, 137-147, 149
	HUS	16	•		•										•	•				--	850 - 5,455	124, 126-129, 133-134, 138-141, 145-146
		14	•		•										•	•				--	850 - 5,455	124, 126-129, 133-134, 138-141, 145-146
	HD	14	•		•					•				•	•	•	•	•		--	615 - 4,620	125-149
	ADTT	14	•		•						•	•	•	•	•	•	•	•		--	790 - 850 <sup>1</sup>	151
	DTB	14	•		•									•	•	•	•	•		--	1835 <sup>1</sup>	152
	HDOIF	14	•		•					•				•	•	•	•	•		--	3,340 - 5,605	125, 128-136, 140-148
FWHFM	12												•	•	•	•	•		--	5,960	150	
Top Mount	HL	18	•		•				•				•	•	•	•	•		--	1,270 - 1,490	154, 157	
	JH	18	•		•				•				•	•					--	1,910 - 2,555	163	
	KLB	14	•		•				•				•	•	•	•	•		--	1,670 - 2,140	155, 157	
	FWH	14	•	•					•	•	•	•	•	•	•	•	•		--	2,240 - 2,400	160-161	
	FWHBP	12	•	•					•				•	•	•	•	•		--	5,695 - 8,015	162	
	KB	12	•		•								•	•	•	•	•		--	4,075 - 4,795	155, 158-159	
	HDO	12	•		•								•	•	•	•	•		--	2,405 - 5,845	155, 157-159	
	SW	12		•	•				•	•				•	•	•	•		--	2,315 - 2,520	156 - 158	
	SWH	7 - Top Flange; 12 - Stirrup		•	•					•	•			•	•	•	•		--	3,305	156 - 159	
KHW	3 - Top Flange; 10 - Stirrup		•	•					•	•			•	•	•	•		--	5,295 - 5,535	156, 158-159		
Slope and Skew	RR	18	•		•		•		•				•	•					--	365 - 380	164	
	LS	18	•		•		•		•				•	•				•	--	785 - 1,235	164	
	LSSH	18	•		•	•	•		•				•	•	•	•	•	•	--	720 - 2,590	165	
		16	•		•	•	•		•				•	•	•	•	•	•	--	720 - 2,590	165	
	SKH	14	•		•	•	•		•				•	•	•	•	•		--	510 - 3,100	166-167	
SKHH	14	•		•	•	•		•				•	•	•	•	•		--	1,795 - 4,005	166-167		
Panel and Purin	JPF	20	•		•				•				•	•					--	1,035	169	
	DTUS	20	•		•		•		•				•	•					--	485 - 580	171	
	TUS	20	•		•		•		•				•	•					--	485 - 580	171	
	KF	18	•		•		•		•				•	•					--	695 - 810	168	
	PHG	18	•		•		•		•				•	•					--	580 - 650	168	
	FHD	18	•		•		•		•				•	•					--	960	172	
	JDS	18	•		•		•		•				•	•					--	480 - 1,675	170	
Masonry	HD	14	•		•				•	•			•	•	•	•	•		335 - 5750	--	173	
	MPH	12		•									•	•	•	•	•		2,585 - 4,280	--	177-178	
	LGUM	12											•	•	•	•	•		6,065 - 9,905	--	174	
	HGUM	7											•	•	•	•	•		16,680	--	174	
	HWUH	1/4" - Top Flange; 7 - Stirrup		•		•				•	•			•	•	•	•		3,060 - 5,265	--	175-176	
	UMH	1/4"		•									•	•	•	•	•		3,550 - 6,380	--	179	
	NFM	3/8" - Top Flange; 7 - Stirrup		•									•	•	•	•	•		6,720 - 10,310	--	179-180	

• Represents common applications and product configurations. Consult MiTek for additional applications and/or optional product configurations.

1) Allowable loads reflect DF/SP Tension 160%.

2) When an I-Joist is used as a header, designer must evaluate if a web stiffener or backer block is required.

New products or updated product information are designated in **blue font**.

Copyright © 2019 MiTek Industries, Inc. All Rights Reserved

Hangers

MiTek offers a wide variety of light-gauge face mount joist hangers to accommodate application and installation preferences.

**JL series** – 20 gauge, 2x dimensional joist hangers.

**JLIF series** – 18 gauge, 2x dimensional joist hangers. For installation at end of post or beam or where inverted flange is needed.

**SUH series** – 16 gauge steel construction for more demanding applications and light truss support.

**Materials:** See chart

**Finish:** G90 galvanizing; JLIF–G-185 galvanizing

**Options:** See chart for Corrosion Finish Options. See SUH Specialty Options Chart.

**Codes:** See page 12 for Code Reference Chart

**Installation:**

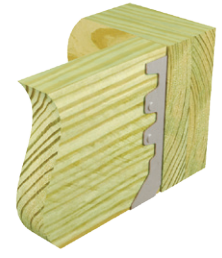
- Use all specified fasteners. See Product Notes, page 20.



**Typical JL26 installation**



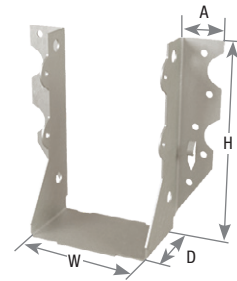
**Typical SUH26-2 installation**



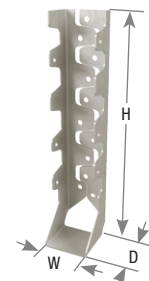
**Typical JL210IF-TZ inverted flange installation**



**JL26**



**SUH26-2**



**JLIF**

**SUH Specialty Options Chart**

Refer to Specialty Options pages 283-284 for additional details.

Option <sup>4</sup>	Skewed <sup>1,3</sup>	Sloped Seat <sup>2,3</sup>	Sloped / Skewed <sup>1,2,3</sup>
<b>Range</b>	1° to 67-1/2° when width is 1-3/4" or less. 1° to 50° on all others.	1° to 45°	See Sloped Seat and Skewed
<b>Allowable Loads</b>	100% of table load. 75% of uplift load on skews greater than 15°.	100% of table load	80% of table load. 75% of uplift load on skews greater than 15°.
<b>Ordering</b>	Add <i>SK</i> angle required, right ( <i>R</i> ) or left ( <i>L</i> ), and square cut ( <i>SQ</i> ) or bevel cut ( <i>BV</i> ) to product number. Ex. SUH210_SK45R_SQ	Add <i>SL</i> , slope required, and up ( <i>U</i> ) or down ( <i>D</i> ), to product number. Ex. SUH210_SL30D	See Sloped Seat and Skewed. Ex. SUH210_SK45R_SQ_SL30D

- 1) Skewed hangers with skews greater than 15° may have all joist nailing on outside flange.
- 2) Sloped or sloped / skewed hangers with slopes greater than 15° may have additional joist nails.
- 3) For skewed hangers, the required cut type (square or bevel) of joist member may vary based on skew angle and width of hanger. Some square cut hangers will require custom pricing due to welded back plate.
- 4) SUH option hangers may be manufactured as welded products to achieve listed loads. Welded products have a primer finish.

The HUS, JUS and MUS hanger series offers double shear nailing. MiTek's dimple allows for 30° to 45° nailing through the joist into the header resulting in higher loads and less nailing. Slant nailing allows for higher load values, fewer nails, and faster installation.

**Materials:** JUS – 18 gauge; MUS – 18 gauge; HUS – 14 or 16 gauge

**Finish:** G90 galvanizing

**Options:** See chart for Corrosion Finish Options. See HUS Specialty Options Chart.

**Codes:** See page 12 for Code Reference Chart

**Installation:**

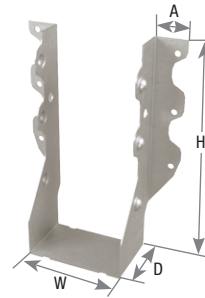
- Use all specified fasteners. See Product Notes, page 20.
- Joist nails must be driven at a 30° to 45° angle through the joist or truss into the header to achieve listed loads. **Slant/double shear nails must be used to achieve listed load values.**
- JUS & MUS – 16d sinkers (0.148" x 3-1/4") may be used where 10d commons are specified with no load reduction.



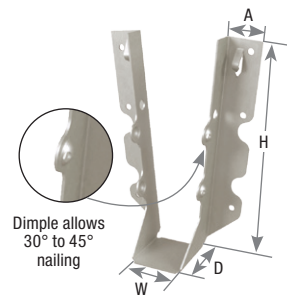
**Typical HUS46 installation**



**Typical JUS26 installation**



**HUS28-2**

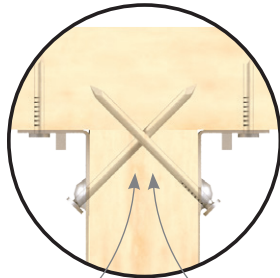


**JUS28**

AVAILABLE IN  
**GOLD  
COAT**



**MUS**



Double shear nail design features fewer nails and faster installation

Uses standard length common nails

**HUS Specialty Options Chart**

Refer to Specialty Options pages 283-284 for additional details.

Option	Inverted Flange
<b>Range</b>	Not available in widths less than 2-1/4".
<b>Allowable Loads</b>	100% of table load. 65% of table load when nailing into the support members end grain.
<b>Ordering</b>	Add <i>/F</i> to product number. Ex. HUS410_IF



**Typical HUS410IF inverted flange installation**

# HD Heavy-Duty Face Mount Hangers

HD hangers are heavy-duty face mount hangers utilizing round and diamond holes to achieve design flexibility and maximum loads for use with headers, joists, and trusses.

**Materials:** 14 gauge

**Finish:** G90 galvanizing

**Options:** See chart for Corrosion Finish Options. All nominal lumber sizes are available rough/full size lumber. See Specialty Options Chart.

**Codes:** See page 12 for Code Reference Chart

**Installation:**

- Use all specified fasteners. See Product Notes, page 20.
- **Min Nailing** – Fill all round nail holes.
- **Max Nailing** – Fill all round and diamond nail holes.
- 16d sinkers (0.148" dia. x 3-1/4" long) may be used at 0.84 of the table load where 16d commons are specified.



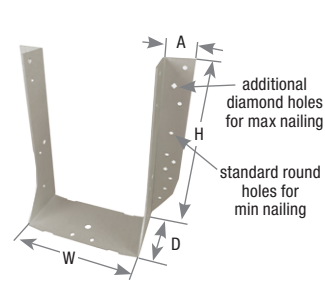
**Typical HD610 installation**



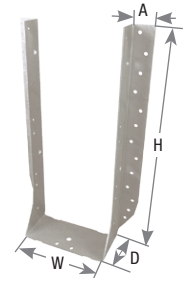
**Typical HD210-2 installation**



**Typical HD3212 glulam installation**



**HD610**



**HD51135**

**Specialty Options Chart**

Refer to Specialty Options pages 283-284 for additional details.

Option	Skewed <sup>1,3</sup>	Sloped Seat <sup>2,3</sup>	Sloped / Skewed <sup>1,2,3</sup>	Inverted Flange
<b>Range</b>	1° to 67-1/2° when width is 1-3/4" or less. 1° to 50° on all others.	1° to 45°	See Sloped Seat and Skewed	2-1/4" widths or greater (Widths < 2-1/4" may be available as a Custom, contact MiTek)
<b>Allowable Loads</b>	100% of table load. 75% of uplift load on skews greater than 15°.	100% of table load	80% of table load. 75% of uplift load on skews greater than 15°.	100% of table load. 65% of table load when nailing into the support members end grain.
<b>Ordering</b>	Add <i>SK</i> , angle required, right ( <i>R</i> ) or left ( <i>L</i> ), and square cut ( <i>SQ</i> ) or bevel cut ( <i>BV</i> ) to product number. Example: HD410_SK45R_SQ	Add <i>SL</i> , slope required, and up ( <i>U</i> ) or down ( <i>D</i> ), to product number. Example: HD410_SL30D	See Sloped Seat and Skewed Example: HD410_SK45R_SQ_SL30D	Add <i>IF</i> , to product number. Example: HD410_IF



**Typical HD210-2IF inverted flange installation**

- 1) Skewed hangers with skews greater than 15° may have all joist nailing on outside flange.
- 2) Sloped or sloped / skewed hangers with slopes greater than 15° may have additional joist nails.
- 3) For skewed hangers, the required cut type (square or bevel) of joist member may vary based on skew angle and width of hanger. Some square cut hangers will require custom pricing due to welded back plate.
- 4) HD option hangers may be manufactured as welded products to achieve listed loads. Welded products have a primer interior finish.

## HDQIF Inverted Flange Face Mount Hangers

HDQIF inverted flange hangers install with wood screws eliminating the need to drill bolt holes, simplifying installation.

**Materials:** 14 gauge

**Finish:** G90 galvanizing

**Options:** See chart for Corrosion Finish Options

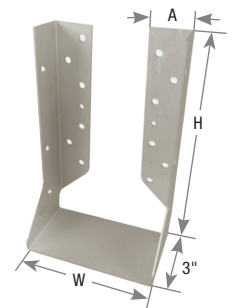
**Codes:** See page 12 for Code Reference Chart

**Installation:**

- Use all specified fasteners. See Product Notes, page 20.
- WS15 (1/4" dia. x 1-1/2" long) and WS3 (1/4" dia. x 3" long) Wood Screws are supplied with HDQIF hangers.



**Typical HDQIF inverted flange installation**



**HDQIF**

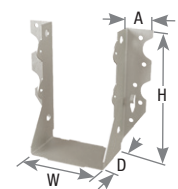
# Face Mount Hangers – DF/SP Allowable Loads

Joist Size	MiTek USP Stock No.	Ref. No.	Steel Gauge	Dimensions (in)				Fastener Schedule <sup>3</sup>				DF/SP Allowable Loads (Lbs.) <sup>2</sup>				Corrosion Finish	Code Ref.
								Header		Joist		Floor		Roof			
				W	H	D	A	Min/Max	Qty	Type	Qty	Type	100%	115%	125%		
2 x 4	JL24	LU24	20	1-9/16	3	1-1/2	15/16	--	4	10d	2	10d x 1-1/2	470	540	580	295	
													560	640	675		
	JL24IF-TZ	--	18	1-9/16	3-1/8	1-1/2	--	--	4	10d HDG	2	10d x 1-1/2 HDG	465	535	580	280	
													550	615	615		
	JUS24	LUS24	18	1-9/16	3-1/8	1-3/4	1	--	4	10d	2	10d	675	775	835	630	
SUH24	U24	16	1-9/16	3-1/4	2	1-3/16	--	4	10d	2	10d x 1-1/2	500	560	605	380		
												590	665	720			
	HD26	HU26	14	1-9/16	3-1/2	2-1/2	1-1/8	Min	4	16d	2	10d x 1-1/2	615	695	745	335	
								Max	4		4					585	
2 x 6	JL26	LU26	20	1-9/16	4-3/4	1-1/2	15/16	--	6	10d	4	10d x 1-1/2	710	805	870	600	
													840	960	1045		
	JL26IF-TZ	LUC26Z	18	1-9/16	4-1/2	1-1/2	--	--	6	10d HDG	4	10d x 1-1/2 HDG	695	800	870	730	
													830	950	1035		
	JUS26	LUS26	18	1-9/16	4-13/16	1-3/4	1	--	4	10d	4	10d	870	1000	1080	1000	
	MUS26	MUS26	18	1-9/16	5-1/16	2	1	--	6	10d	6	10d	1285	1475	1605	865	
	SUH26	U26	16	1-9/16	5-1/8	2	1-3/16	--	6	10d	4	10d x 1-1/2	750	840	910	755	
													880	1000	1080		
	HUS26	HUS26	16	1-5/8	5-7/16	3	2	--	14	16d	6	16d	2760	3140	3400	2035	
	HD26	HU26	14	1-9/16	3-1/2	2-1/2	1-1/8	Min	4	16d	2	10d x 1-1/2	615	695	745	335	
								Max	4		4					585	
	HD28	HU28	14	1-9/16	5-1/4	2-1/2	1-1/8	--	8	16d	6	10d x 1-1/2	1230	1390	1490	760	
2 x 8	JL26	LU26	20	1-9/16	4-3/4	1-1/2	15/16	--	6	10d	4	10d x 1-1/2	710	805	870	600	
													840	960	1045		
	JL26IF-TZ	LUC26Z	18	1-9/16	4-1/2	1-1/2	--	--	6	10d HDG	4	10d x 1-1/2 HDG	695	800	870	730	
													830	950	1035		
	JL28	LU28	20	1-9/16	6-3/8	1-1/2	15/16	--	10	10d	6	10d x 1-1/2	1180	1345	1450	795	
													1400	1600	1740		
	JL28IF-TZ	--	18	1-9/16	6-1/8	1-1/2	--	--	8	10d HDG	4	10d x 1-1/2 HDG	930	1065	1160	730	
													1105	1215	1215		
	JUS26	LUS26	18	1-9/16	4-13/16	1-3/4	1	--	4	10d	4	10d	870	1000	1080	1000	
	JUS28	LUS28	18	1-9/16	6-5/8	1-3/4	1	--	6	10d	4	10d	1110	1270	1375	1000	
	MUS26	MUS26	18	1-9/16	5-1/16	2	1	--	6	10d	6	10d	1285	1475	1605	865	
	MUS28	MUS28	18	1-9/16	7-1/16	2	1	--	8	10d	8	10d	1710	1970	2140	1230	
	SUH26	U26	16	1-9/16	5-1/8	2	1-3/16	--	6	10d	4	10d x 1-1/2	750	840	910	755	
													880	1000	1080		
	SUH28	--	16	1-9/16	6-5/8	2	1-3/16	--	8	10d	6	10d x 1-1/2	1000	1120	1210	830	
												1175	1335	1440			
	HUS26	HUS26	16	1-5/8	5-7/16	3	2	--	14	16d	6	16d	2760	3140	3400	2035	
	HUS28	HUS28	16	1-5/8	7-3/16	3	2	--	22	16d	8	16d	4170	4745	5090	2950	
	HD28	HU28	14	1-9/16	5-1/4	2-1/2	1-1/8	--	8	16d	6	10d x 1-1/2	1230	1390	1490	760	
	HD210	HU210	14	1-9/16	7-3/16	2-1/2	1-1/8	Min	10	16d	4	10d x 1-1/2	1540	1735	1865	760	
								Max	14		6		2155	2430	2610	1170	

IBC, FL, LA

1) Uplift loads have been increased 60% for wind or seismic loads; no further increase shall be permitted.  
 2) For JUS, HUS, and MUS hangers: Nails must be driven at a 30° to 45° angle through the joist or truss into the header to achieve the table loads.  
 3) **NAILS:** 10d x 1-1/2 nails are 0.148" dia. x 1-1/2" long, 10d nails are 0.148" dia. x 3" long, 16d nails are 0.162" dia. x 3-1/2" long.  
 New products or updated product information are designated in **blue font**.

**Corrosion Finish** ■ Stainless Steel ■ Gold Coat ■ HDG ■ Triple Zinc



Copyright © 2019 MiTek Industries, Inc. All Rights Reserved

# Face Mount Hangers – DF/SP Allowable Loads

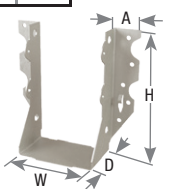
Joist Size	MiTek USP Stock No.	Ref. No.	Steel Gauge	Dimensions (in)				Fastener Schedule <sup>3</sup>				DF/SP Allowable Loads (Lbs.) <sup>2</sup>				Corrosion Finish	Code Ref.		
				W	H	D	A	Min/Max	Header		Joist		Floor		Roof			Uplift <sup>1</sup>	
									Qty	Type	Qty	Type	100%	115%	125%				160%
2 x 10	JL28	LU28	20	1-9/16	6-3/8	1-1/2	15/16	--	10	10d	6	10d x 1-1/2	1180	1345	1450	795			
	JL28IF-TZ	--	18	1-9/16	6-1/8	1-1/2	--	--	8	10d HDG	4	10d x 1-1/2 HDG	930	1065	1160	730			
										16d HDG			1105	1215	1215				
	JL210	LU210	20	1-9/16	8-1/4	1-1/2	15/16	--	14	10d	8	10d x 1-1/2	1650	1885	1930	1005			
	JL210IF-TZ	LUC210Z	18	1-9/16	8-1/4	1-1/2	--	--	11	10d HDG	6	10d x 1-1/2 HDG	1275	1465	1595	1095			
										16d HDG			1520	1745	1900				
	JUS28	LUS28	18	1-9/16	6-5/8	1-3/4	1	--	6	10d	4	10d	1110	1270	1375	1000			
	JUS210	LUS210	18	1-9/16	7-3/4	1-3/4	1	--	8	10d	4	10d	1350	1545	1670	1000			
	MUS28	MUS28	18	1-9/16	7-1/16	2	1	--	8	10d	8	10d	1710	1970	2140	1230			
	SUH28	--	16	1-9/16	6-5/8	2	1-3/16	--	8	10d	6	10d x 1-1/2	1000	1120	1210	830			
16d										1175			1335	1440					
SUH210	U210	16	1-9/16	8	2	1-3/16	--	10	10d	6	10d x 1-1/2	1250	1405	1515	1135				
									16d			1470	1670	1800					
HUS28	HUS28	16	1-5/8	7-3/16	3	2	--	22	16d	8	16d	4170	4745	5090	2950				
HUS210	HUS210	16	1-5/8	9-3/16	3	2	--	30	16d	10	16d	5455	5825	6040	4110				
HD210	HU210	14	1-9/16	7-3/16	2-1/2	1-1/8	Min	10	16d	4	10d x 1-1/2	1540	1735	1865	760				
								Max				14	6	2155				2430	2610
2 x 12	JL210	LU210	20	1-9/16	8-1/4	1-1/2	15/16	--	14	10d	8	10d x 1-1/2	1650	1885	1930	1005			
	JL210IF-TZ	LUC210Z	18	1-9/16	8-1/4	1-1/2	--	--	11	10d HDG	6	10d x 1-1/2 HDG	1275	1465	1595	1095			
										16d HDG			1520	1745	1900				
	JUS210	LUS210	18	1-9/16	7-3/4	1-3/4	1	--	8	10d	4	10d	1350	1545	1670	1000			
	SUH210	U210	16	1-9/16	8	2	1-3/16	--	10	10d	6	10d x 1-1/2	1250	1405	1515	1135			
										16d			1470	1670	1800				
	HUS210	HUS210	16	1-5/8	9-3/16	3	2	--	30	16d	10	16d	5455	5825	6040	4110			
HD210	HU210	14	1-9/16	7-3/16	2-1/2	1-1/8	Min	10	16d	4	10d x 1-1/2	1540	1735	1865	760				
							Max	14				6	2155	2430				2610	1170
HD212	HU212	14	1-9/16	9-1/4	2-1/2	1-1/8	Min	14	16d	6	10d x 1-1/2	2155	2430	2610	1170				
							Max	20				10	3080	3475				3715	1550
HD212IF	HUC212	14	1-9/16	9-1/4	2	--	--	16	16d	8	10d x 1-1/2	2465	2780	2980	1180				
2 x 14	SUH214	U214	16	1-9/16	10	2	1-1/8	--	12	10d	8	10d x 1-1/2	1500	1685	1815	1510			
										16d			1765	2000	2160				
	HD212	HU212	14	1-9/16	9-1/4	2-1/2	1-1/8	Min	14	16d	6	10d x 1-1/2	2155	2430	2610	1170			
								Max	20				10	3080	3475				3715
HD212IF	HUC212	14	1-9/16	9-1/4	2	--	--	16	16d	8	10d x 1-1/2	2465	2780	2980	1180				
HD214	HU214	14	1-9/16	10-13/16	2-1/2	1-1/8	Min	16	16d	8	10d x 1-1/2	2465	2780	2980	1180				
Max	24	12	3695	4125	4250	1550													
2 x 16	SUH214	U214	16	1-9/16	10	2	1-1/8	--	12	10d	8	10d x 1-1/2	1500	1685	1815	1510			
										16d			1765	2000	2160				
	HD212	HU212	14	1-9/16	9-1/4	2-1/2	1-1/8	Min	14	16d	6	10d x 1-1/2	2155	2430	2610	1170			
								Max	20				10	3080	3475				3715
	HD212IF	HUC212	14	1-9/16	9-1/4	2	--	--	16	16d	8	10d x 1-1/2	2465	2780	2980	1180			
HD214	HU214	14	1-9/16	10-13/16	2-1/2	1-1/8	Min	16	16d	8	10d x 1-1/2	2465	2780	2980	1180				
							Max	24				12	3695	4125				4250	1550
HD216	HU216	14	1-9/16	12-3/4	2-1/2	1-1/8	Min	18	16d	8	10d x 1-1/2	2770	3125	3355	1550				
Max	26	12	3930	4125	4250	1900													

Copyright © 2019 MiTek Industries, Inc. All Rights Reserved

IBC, FL, LA

Hangers

1) Uplift loads have been increased 60% for wind or seismic loads; no further increase shall be permitted.  
 2) For JUS, HUS, and MUS hangers: Nails must be driven at a 30° to 45° angle through the joist or truss into the header to achieve the table loads.  
 3) **NAILS:** 10d x 1-1/2" nails are 0.148" dia. x 1-1/2" long, 10d nails are 0.148" dia. x 3" long, 16d nails are 0.162" dia. x 3-1/2" long.  
 New products or updated product information are designated in blue font.



Corrosion Finish ■ Stainless Steel ■ Gold Coat ■ HDG ■ Triple Zinc

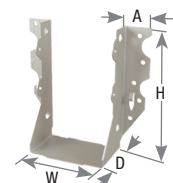
# Face Mount Hangers – DF/SP Allowable Loads

Hangers

Joist Size	MiTek USP Stock No.	Ref. No.	Steel Gauge	Dimensions (in)				Fastener Schedule <sup>3,4</sup>				DF/SP Allowable Loads (Lbs.) <sup>2</sup>				Corrosion Finish	Code Ref.		
				W	H	D	A	Min/Max	Header		Joist		Floor		Roof			Uplift <sup>1</sup>	
									Qty	Type	Qty	Type	100%	115%	125%				160%
(2) 2 x 4	JUS24-2	LUS24-2	18	3-1/8	3-7/16	2	1	--	4	16d	2	16d	805	900	900	630	Green	IBC, FL, LA	
	SUH24-2	U24-2	16	3-1/8	3-1/8	2	1-1/8	--	6	10d 16d	2	10d	750 880	840 1000	910 1080	380	Green		
	HD24-2	HU24-2	14	3-1/8	3-1/2	2-1/2	1-1/8	--	4	16d	2	10d	615	695	745	365	Green		
	HUS24-2	--	14	3-1/8	3-7/16	2	1	--	4	16d	2	16d	850	965	1035	760	Green		
	HUS24-2IF	--	14	3-1/8	3-7/16	2	1	--	4	16d	2	16d	850	965	1035	760	Green		
(2) 2 x 6	JUS26-2	LUS26-2	18	3-1/8	5-1/4	2	1	--	4	16d	4	16d	1040	1185	1290	1255	Green, Blue, Yellow	IBC, FL, LA	
	SUH26-2	U26-2	16	3-1/8	5-1/16	2	1-1/8	--	10	10d 16d	4	10d	1250 1470	1405 1670	1515 1800	755	Green		
	HD24-2	HU24-2	14	3-1/8	3-1/2	2-1/2	1-1/8	--	4	16d	2	10d	615	695	745	365	Green		
	HUS26-2	HUS26-2	14	3-1/8	5-1/4	2	1	--	4	16d	4	16d	1085	1235	1330	1070	Green		
	HUS26-2IF	HUSC26-2	14	3-1/8	5-1/4	2	1	--	4	16d	4	16d	1085	1235	1330	1070	Green		
	HD26-2	HU26-2	14	3-1/8	5-1/4	2-1/2	1-1/8	Min Max	8 12	16d	4 6	10d	1230 1850	1390 2085	1490 2235	760 1170	Green		
	HD26-2IF	HUC26-2	14	3-1/8	5-1/4	2-1/2	--	Min Max	8 12	16d	4 6	10d	1230 1850	1390 2085	1490 2235	760 1170	Green		
(2) 2 x 8	JUS26-2	LUS26-2	18	3-1/8	5-1/4	2	1	--	4	16d	4	16d	1040	1185	1290	1255	Green, Blue, Yellow	IBC, FL, LA	
	JUS28-2	LUS28-2	18	3-1/8	7-1/8	2	1	--	6	16d	4	16d	1325	1510	1645	1255	Green, Blue, Yellow		
	SUH26-2	U26-2	16	3-1/8	5-1/16	2	1-1/8	--	10	10d 16d	4	10d	1250 1470	1405 1670	1515 1800	755	Green		
	SUH28-2	--	16	3-1/8	6-1/4	2	1-1/8	--	12	10d 16d	4	10d	1500 1765	1685 1995	1815 1995	755	Green		
	HUS26-2	HUS26-2	14	3-1/8	5-1/4	2	1	--	4	16d	4	16d	1085	1235	1330	1070	Green		
	HUS26-2IF	HUSC26-2	14	3-1/8	5-1/4	2	1	--	4	16d	4	16d	1085	1235	1330	1070	Green		
	HUS28-2	HUS28-2	14	3-1/8	7-1/8	2	1	--	6	16d	6	16d	1625	1850	1865	2390	Green		
	HUS28-2IF	HUSC28-2	14	3-1/8	7-1/8	2	1	--	6	16d	6	16d	1625	1850	1865	2390	Green		
	HD26-2	HU26-2	14	3-1/8	5-1/4	2-1/2	1-1/8	Min Max	8 12	16d	4 6	10d	1230 1850	1390 2085	1490 2235	760 1170	Green		
	HD26-2IF	HUC26-2	14	3-1/8	5-1/4	2-1/2	--	Min Max	8 12	16d	4 6	10d	1230 1850	1390 2085	1490 2235	760 1170	Green		
	HD28-2	HU28-2	14	3-1/8	7-1/8	2-1/2	1-1/8	Min Max	10 14	16d	4 6	10d	1540 2155	1735 2430	1865 2610	780 1170	Green		
HD28-2IF	HUC28-2	14	3-1/8	7-1/8	2-1/2	--	Min Max	10 14	16d	4 6	10d	1540 2155	1735 2430	1865 2610	780 1170	Green			
(2) 2 x 10	JUS28-2	LUS28-2	18	3-1/8	7-1/8	2	1	--	6	16d	4	16d	1325	1510	1645	1255	Green, Blue, Yellow	IBC, FL, LA	
	JUS210-2	LUS210-2	18	3-1/8	9-1/8	2	1	--	8	16d	6	16d	1845	2105	2290	2335	Green, Blue, Yellow		
	SUH28-2	--	16	3-1/8	6-1/4	2	1-1/8	--	12	10d 16d	4	10d	1500 1765	1685 1995	1815 1995	755	Green		
	SUH210-2	U210-2	16	3-1/8	8-9/16	2	1-1/8	--	16	10d 16d	6	10d	2000 2350	2245 2670	2420 2880	1135	Green		
	HUS28-2	HUS28-2	14	3-1/8	7-1/8	2	1	--	6	16d	6	16d	1625	1850	1865	2390	Green		
	HUS28-2IF	HUSC28-2	14	3-1/8	7-1/8	2	1	--	6	16d	6	16d	1625	1850	1865	2390	Green		
	HD28-2	HU28-2	14	3-1/8	7-1/8	2-1/2	1-1/8	Min Max	10 14	16d	4 6	10d	1540 2155	1735 2430	1865 2610	780 1170	Green		
	HD28-2IF	HUC28-2	14	3-1/8	7-1/8	2-1/2	--	Min Max	10 14	16d	4 6	10d	1540 2155	1735 2430	1865 2610	780 1170	Green		
	HUS210-2	HUS210-2	14	3-1/8	9-1/8	2	1	--	8	16d	8	16d	2170	2465	2660	2390	Green		
	HUS210-2IF	HUSC210-2	14	3-1/8	9-1/8	2	1	--	8	16d	8	16d	2170	2465	2660	2390	Green		
	HD210-2	HU210-2	14	3-1/8	9	2-1/2	1-1/8	Min Max	14 20	16d	6 10	10d	2155 3080	2430 3475	2610 3715	1170 1950	Green		
	HD210-2IF	HUC210-2	14	3-1/8	9	2-1/2	--	Min Max	14 20	16d	6 10	10d	2155 3080	2430 3475	2610 3715	1170 1950	Green		
	HDQ210-2IF	HUCQ210-2	14	3-1/4	9	3	1-1/2	--	12	WS3	6	WS3	5015	5590	5590	2975	Green, Blue, Yellow		

- 1) Uplift loads have been increased 60% for wind or seismic loads; no further increase shall be permitted.
- 2) For JUS and HUS hangers: Nails must be driven at a 30° to 45° angle through the joist or truss into the header to achieve the table loads.
- 3) WS3 Wood Screws are 1/4" dia. x 3" long and are included with HDQ hangers.
- 4) **NAILS:** 10d nails are 0.148" dia. x 3" long, 16d are 0.162" dia. x 3-1/2" long.

**Corrosion Finish** ■ Stainless Steel ■ Gold Coat ■ HDG ■ Triple Zinc





Joist Size	MiTek USP Stock No.	Ref. No.	Steel Gauge	Dimensions (in)				Fastener Schedule <sup>3,4</sup>				DF/SP Allowable Loads (Lbs.) <sup>2</sup>				Corrosion Finish	Code Ref.	
				W	H	D	A	Min/Max	Header		Joist		Floor	Roof				Uplift <sup>1</sup>
									Qty	Type	Qty	Type		100%	115%			
(2) 2 x 12	JUS210-2	LUS210-2	18	3-1/8	9-1/8	2	1	--	8	16d	6	16d	1845	2105	2290	2335	Green	
	SUH210-2	U210-2	16	3-1/8	8-9/16	2	1-1/8	--	16	10d	6	10d	2000	2245	2420	1135	Grey	
										16d			2350	2670	2880			
	HUS210-2	HUS210-2	14	3-1/8	9-1/8	2	1	--	8	16d	8	16d	2170	2465	2660	2390	Green	
	HUS210-2IF	HUSC210-2	14	3-1/8	9-1/8	2	1	--	8	16d	8	16d	2170	2465	2660	2390	Green	
	HD210-2	HU210-2	14	3-1/8	9	2-1/2	1-1/8	Min	14	16d	6	10d	2155	2430	2610	1170	Green	
									20				3080	3475	3715	1950		
	HD210-2IF	HUC210-2	14	3-1/8	9	2-1/2	--	Min	14	16d	6	10d	2155	2430	2610	1170	Green	Blue
									20				3080	3475	3715	1950		
	HUS212-2	HUS212-2	14	3-1/8	11-1/8	2	1	--	10	16d	10	16d	2710	3080	3325	3825	Green	
HUS212-2IF	HUSC212-2	14	3-1/8	11-1/8	2	--	--	10	16d	10	16d	2710	3080	3325	3825	Green		
HD212-2	HU212-2	14	3-1/8	11	2-1/2	1-1/8	Min	16	16d	8	10d	2465	2780	2980	1305	Green		
								24				3695	4170	4470	2340			
HD212-2IF	HUC212-2	14	3-1/8	11	2-1/2	--	Min	16	16d	8	10d	2465	2780	2980	1305	Green		
								24				3695	4170	4470	2340			
HDQ210-2IF	HUCQ210-2	14	3-1/4	9	3	1-1/2	--	12	WS3	6	WS3	5015	5590	5590	2975	Blue		
(2) 2 x 14	JUS210-2	LUS210-2	18	3-1/8	9-1/8	2	1	--	8	16d	6	16d	1845	2105	2290	2335	Green	
	JUS214-2	LUS214-2	18	3-1/8	13-1/8	2	1	--	12	16d	6	16d	2420	2755	2830	2335	Green	
	SUH210-2	U210-2	16	3-1/8	8-9/16	2	1-1/8	--	16	10d	6	10d	2000	2245	2420	1135	Grey	
										16d			2350	2670	2880			
	HD210-2	HU210-2	14	3-1/8	9	2-1/2	1-1/8	Min	14	16d	6	10d	2155	2430	2610	1170	Green	
									20				3080	3475	3715	1950		
	HD210-2IF	HUC210-2	14	3-1/8	9	2-1/2	--	Min	14	16d	6	10d	2155	2430	2610	1170	Green	Blue
									20				3080	3475	3715	1950		
	HUS210-2	HUS210-2	14	3-1/8	9-1/8	2	1	--	8	16d	8	16d	2170	2465	2660	2390	Green	
	HUS210-2IF	HUSC210-2	14	3-1/8	9-1/8	2	1	--	8	16d	8	16d	2170	2465	2660	2390	Green	
HUS212-2	HUSC212-2	14	3-1/8	11-1/8	2	1	--	10	16d	10	16d	2710	3080	3325	3825	Green		
HUS212-2IF	HUSC212-2	14	3-1/8	11-1/8	2	1	--	10	16d	10	16d	2710	3080	3325	3825	Green		
HD212-2	HU212-2	14	3-1/8	11	2-1/2	1-1/8	Min	16	16d	8	10d	2465	2780	2980	1305	Green		
								24				3695	4170	4470	2340			
HD212-2IF	HUC212-2	14	3-1/8	11	2-1/2	--	Min	16	16d	8	10d	2465	2780	2980	1305	Green		
								24				3695	4170	4470	2340			
HD214-2	HU214-2	14	3-1/8	13	2-1/2	1-1/8	Min	18	16d	8	10d	2770	3125	3355	1550	Green		
								26				4005	4515	4845	2340			
HDQ210-2IF	HUCQ210-2	14	3-1/4	9	3	1-1/2	--	12	WS3	6	WS3	5015	5590	5590	2975	Blue		
(2) 2 x 16	JUS214-2	LUS214-2	18	3-1/8	13-1/8	2	1	--	12	16d	6	16d	2420	2755	2830	2335	Green	
	HD212-2	HU212-2	14	3-1/8	11	2-1/2	1-1/8	Min	16	16d	8	10d	2465	2780	2980	1305	Green	
									24				3695	4170	4470	2340		
	HD212-2IF	HUC212-2	14	3-1/8	11	2-1/2	--	Min	16	16d	8	10d	2465	2780	2980	1305	Green	
									24				3695	4170	4470	2340		
HD214-2	HU214-2	14	3-1/8	13	2-1/2	1-1/8	Min	18	16d	8	10d	2770	3125	3355	1550	Green		
								26				4005	4515	4845	2340			
HD216-2	HU216-2	14	3-1/8	14	2-1/2	1-1/8	Min	22	16d	10	10d	3390	3820	4100	1950	Green		
								30				4620	5035	5035	2735			
3 x 4	SUH34	U34	16	2-9/16	3-3/8	2	1-1/8	--	6	10d	2	10d x 1-1/2	750	840	910	380	Green	
										16d			880	1000	1080			
	HD34	HU34	14	2-9/16	3	2-1/2	1-1/8	Min	4	16d	4	10d x 1-1/2	615	695	745	335	Green	
Max									4				585					
HD34IF	HUC34	14	2-9/16	3	2-1/2	--	Min	4	16d	2	10d x 1-1/2	615	695	745	335	Green		
								Max				4	585					

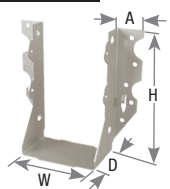
IBC, FL, LA

Hangers

Copyright © 2019 MiTek Industries, Inc. All Rights Reserved

1) Uplift loads have been increased 60% for wind or seismic loads; no further increase shall be permitted.  
 2) For JUS and HUS hangers: Nails must be driven at a 30° to 45° angle through the joist or truss into the header to achieve the table loads.  
 3) WS15 is 1/4" dia. x 1-1/2" long wood screw, WS3 is 1/4" x 3" long wood screw and are included with HDQ hangers.  
 4) NAILS: 10d x 1-1/2 nails are 0.148" dia. x 1-1/2" long, 10d nails are 0.148" dia. x 3" long, 16d nails are 0.162" dia. x 3-1/2" long.

Corrosion Finish ■ Stainless Steel ■ Gold Coat ■ HDG ■ Triple Zinc

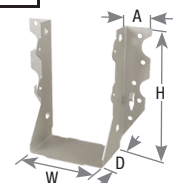


# Face Mount Hangers – DF/SP Allowable Loads

Joist Size	MiTek USP Stock No.	Ref. No.	Steel Gauge	Dimensions (in)				Fastener Schedule <sup>3,4</sup>				DF/SP Allowable Loads (Lbs.) <sup>2</sup>				Corrosion Finish	Code Ref.	
				W	H	D	A	Min/Max	Header		Joist		Allowable Loads (Lbs.) <sup>2</sup>					
									Qty	Type	Qty	Type	Floor 100%	Roof 115%	Uplift <sup>1</sup> 125%			160%
3 x 6	JUS36	LUS36	18	2-9/16	5-1/4	2	1	--	4	16d	4	16d	1040	1185	1290	1255		
	SUH36	U36	16	2-9/16	5-5/16	2	1-1/8	--	10	10d	4	10d x 1-1/2	1250	1405	1515	755		
	HD36	HU36	14	2-9/16	4-3/4	2-1/2	1-1/8	--	8	16d	6	10d x 1-1/2	1230	1390	1490	760		
	HD36IF	HUC36	14	2-9/16	4-3/4	2-1/2	--	--	8	16d	6	10d x 1-1/2	1230	1390	1490	760		
3 x 8	JUS38	--	18	2-9/16	6-3/4	2	1	--	6	16d	4	16d	1325	1510	1645	1255		
	SUH36	U36	16	2-9/16	5-5/16	2	1-1/8	--	10	10d	4	10d x 1-1/2	1250	1405	1515	755		
	HD38	HU38	14	2-9/16	6-11/16	2-1/2	1-1/8	Min	10	16d	4	10d x 1-1/2	1540	1735	1865	760		
	HD38IF	HUC38	14	2-9/16	6-11/16	2-1/2	--	Max	14	16d	6	10d x 1-1/2	2155	2430	2610	1170		
3 x 10	JUS310	LUS310	18	2-9/16	9-1/8	2	1	--	8	16d	6	16d	1845	2105	2290	2335		
	SUH310	U310	16	2-9/16	8-7/8	2	1-1/8	--	16	10d	6	10d x 1-1/2	2000	2245	2420	1135		
	HD38	HU38	14	2-9/16	6-3/4	2	1-1/8	Min	10	16d	4	10d x 1-1/2	1540	1735	1865	760		
	HD38IF	HUC38	14	2-9/16	6-3/4	2	--	Max	14	16d	6	10d x 1-1/2	2155	2430	2610	1170		
	HD310	HU310	14	2-9/16	7-7/16	2-1/2	1-1/8	Min	10	16d	4	10d x 1-1/2	1540	1735	1865	760		
	HD310IF	HUC310	14	2-9/16	7-7/16	2-1/2	--	Max	14	16d	6	10d x 1-1/2	2155	2430	2610	1170		
	HDQ310IF	HUCQ310	14	2-9/16	9	3	1-3/16	--	8	WS3	4	WS15	3340	3605	3605	1110		IBC, FL, LA
	SUH310	U310	16	2-9/16	8-7/8	2	1-1/8	--	16	10d	6	10d x 1-1/2	2000	2245	2420	1135		
3 x 12	HD310	HU310	14	2-9/16	7-7/16	2-1/2	1-1/8	Min	10	16d	4	10d x 1-1/2	1540	1735	1865	760		
	HD310IF	HUC310	14	2-9/16	7-7/16	2-1/2	--	Max	14	16d	6	10d x 1-1/2	2155	2430	2610	1170		
	HDQ310IF	HUCQ310	14	2-9/16	9	3	1-3/16	--	8	WS3	4	WS15	3340	3605	3605	1110		
	HD312	HU312	14	2-9/16	9-5/16	2-1/2	1-1/8	Min	14	16d	6	10d x 1-1/2	2155	2430	2610	1170		
	HD312IF	HUC312	14	2-9/16	9-5/16	2-1/2	--	Max	20	16d	10	10d x 1-1/2	3080	3475	3715	1550		
	HD312IF	HUC312	14	2-9/16	9-5/16	2-1/2	--	Min	14	16d	6	10d x 1-1/2	2155	2430	2610	1170		
3 x 14	SUH314	U314	16	2-9/16	10-9/16	2	1-1/8	--	18	10d	6	10d x 1-1/2	2250	2525	2725	1135		
	HDQ310IF	HUCQ310	14	2-9/16	9	3	1-3/16	--	8	WS3	4	WS15	3340	3605	3605	1110		
	HD312	HU312	14	2-9/16	9-5/16	2-1/2	1-1/8	Min	14	16d	6	10d x 1-1/2	2155	2430	2610	1170		
	HD312IF	HUC312	14	2-9/16	9-5/16	2-1/2	--	Max	20	16d	10	10d x 1-1/2	3080	3475	3715	1550		
	HD314	HU314	14	2-9/16	11-5/16	2-1/2	1-1/8	Min	16	16d	8	10d x 1-1/2	2465	2780	2980	1180		
	HD314IF	HUC314	14	2-9/16	11-5/16	2-1/2	--	Max	24	16d	12	10d x 1-1/2	3695	4170	4435	1900		

1) Uplift loads have been increased 60% for wind or seismic loads; no further increase shall be permitted.  
 2) For JUS and HUS hangers: Nails must be driven at a 30° to 45° angle through the joist or truss into the header to achieve the table loads.  
 3) WS15 is 1/4" dia. x 1-1/2" long wood screw, WS3 is 1/4" dia. x 3" long wood screw and are included with HDQ hangers.  
 4) NAILS: 10d x 1-1/2 nails are 0.148" dia. x 1-1/2" long, 10d nails are 0.148" dia. x 3" long, 16d nails are 0.162" dia. x 3-1/2" long.

Corrosion Finish ■ Stainless Steel ■ Gold Coat ■ HDG ■ Triple Zinc



Joist Size	MiTek USP Stock No.	Ref. No.	Steel Gauge	Dimensions (in)				Fastener Schedule <sup>3,4</sup>				DF/SP Allowable Loads (Lbs.) <sup>2</sup>				Corrosion Finish	Code Ref.		
				W	H	D	A	Min/Max	Header		Joist		Floor		Roof			Uplift <sup>1</sup>	
									Qty	Type	Qty	Type	100%	115%	125%				160%
3 x 16	SUH314	U314	16	2-9/16	10-9/16	2	1-1/8	--	18	10d	6	10d x 1-1/2	2250	2525	2725	1135			
	HD314	HU314	14	2-9/16	11-5/16	2-1/2	1-1/8	Min	16	16d	8	10d x 1-1/2	2465	2780	2980	1180			
	HD314IF	HUC314	14	2-9/16	11-5/16	2-1/2	--	Min	16	16d	8	10d x 1-1/2	2465	2780	2980	1180			
	HD316	HU316	14	2-9/16	13-5/16	2-1/2	1-1/8	Max	24	16d	12	10d x 1-1/2	3695	4170	4435	1900			
	HD316IF	HUC316	14	2-9/16	13-5/16	2-1/2	--	Max	24	16d	12	10d x 1-1/2	3695	4170	4435	1900			
(2) 3 x 8	HD38-2	HU38-2	14	5-1/8	6-1/8	2-1/2	1-1/8	Min	10	16d	4	10d	1540	1735	1865	780			
								Max	14	16d	6	10d	2155	2430	2610	1170			
(2) 3 x 10	HD38-2	HU38-2	14	5-1/8	6-1/8	2-1/2	1-1/8	Min	10	16d	4	10d	1540	1735	1865	780			
	HD310-2	HU310-2	14	5-1/8	8	2-1/2	1-1/8	Max	14	16d	6	10d	2155	2430	2610	1170			
(2) 3 x 12	HD312-2	HU312-2	14	5-1/8	10	2-1/2	1-1/8	Min	16	16d	8	10d	2465	2780	2980	1305			
								Max	24	16d	12	10d	3695	4170	4470	2340			
(2) 3 x 14	HD312-2	HU312-2	14	5-1/8	10	2-1/2	1-1/8	Min	16	16d	8	10d	2465	2780	2980	1305			
								Max	24	16d	12	10d	3695	4170	4470	2340			
(3) 2 x 6	JUS26-3	LUS26-3	18	4-5/8	4-1/2	2	1	--	4	16d	4	16d	1040	1185	1290	1255			
	SUH26-3	U26-3	16	4-5/8	5-1/4	2	1	--	8	10d	2	10d	1000	1120	1210	380			
	HD26-3	HU26-3	14	4-5/8	4-1/2	2-1/2	1-1/8	Min	8	16d	4	10d	1230	1390	1490	760			
	HD26-3IF	HUC26-3	14	4-5/8	4-1/2	2-1/2	--	Max	12	16d	6	10d	1850	2085	2235	1170			
(3) 2 x 8	JUS26-3	LUS26-3	18	4-5/8	4-1/2	2	1	--	4	16d	4	16d	1040	1185	1290	1255			
	JUS28-3	LUS28-3	18	4-5/8	6-3/8	2	1	--	6	16d	4	16d	1325	1510	1645	1255			
	SUH26-3	U26-3	16	4-5/8	5-1/4	2	1	--	8	10d	2	10d	1000	1120	1210	380			
	HD26-3	HU26-3	14	4-5/8	4-1/2	2-1/2	1-1/8	Min	8	16d	4	10d	1230	1390	1490	760			
	HD26-3IF	HUC26-3	14	4-5/8	4-1/2	2-1/2	--	Max	12	16d	6	10d	1850	2085	2235	1170			
	HD28-3	--	14	4-5/8	6-3/8	2-1/2	1-1/8	Min	10	16d	4	10d	1540	1735	1865	780			
	HD28-3IF	--	14	4-5/8	6-3/8	2-1/2	--	Max	14	16d	6	10d	2155	2430	2610	1170			
(3) 2 x 10	JUS28-3	LUS28-3	18	4-5/8	6-3/8	2	1	--	6	16d	4	16d	1325	1510	1645	1255			
	JUS210-3	LUS210-3	18	4-5/8	8-3/8	2	1	--	8	16d	6	16d	1845	2105	2290	2335			
	SUH210-3	U210-3	16	4-5/8	8-3/8	2	1	--	14	10d	6	10d	1750	1965	1995	1135			
	HD28-3	--	14	4-5/8	6-3/8	2-1/2	1-1/8	Min	10	16d	4	10d	1540	1735	1865	780			
	HD28-3IF	--	14	4-5/8	6-3/8	2-1/2	--	Max	14	16d	6	10d	2155	2430	2610	1170			
	HD210-3	HU210-3	14	4-5/8	8-1/4	2-1/2	1-1/8	Min	14	16d	6	10d	2155	2430	2610	1170			
	HD210-3IF	HUC210-3	14	4-5/8	8-1/4	2-1/2	--	Max	20	16d	10	10d	3080	3475	3725	1950			
	HDQ210-3IF	HUCQ210-3	14	4-5/8	9	3	1-1/2	--	12	WS3	6	WS3	5015	5590	5590	2975			

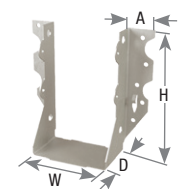
IBC, FL, LA

Copyright © 2019 MiTek Industries, Inc. All Rights Reserved

Hangers

1) Uplift loads have been increased 60% for wind or seismic loads; no further increase shall be permitted.  
 2) For JUS and HUS hangers: Nails must be driven at a 30° to 45° angle through the joist or truss into the header to achieve the table loads.  
 3) WS3 Wood Screws are 1/4" dia. x 3" long and are included with HDQ hangers.  
 4) **NAILS:** 10d x 1-1/2 nails are 0.148" dia. x 1-1/2" long, 10d nails are 0.148" dia. x 3" long, 16d nails are 0.162" dia. x 3-1/2" long.

**Corrosion Finish** ■ Stainless Steel ■ Gold Coat ■ HDG ■ Triple Zinc



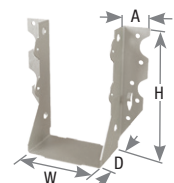
# Face Mount Hangers – DF/SP Allowable Loads

Hangers

Joist Size	MiTek USP Stock No.	Ref. No.	Steel Gauge	Dimensions (in)				Fastener Schedule <sup>3,4</sup>				DF/SP Allowable Loads (Lbs.) <sup>2</sup>				Corrosion Finish	Code Ref.	
								Header		Joist		Floor		Roof				Uplift <sup>1</sup>
				Min/Max	Qty	Type	Qty	Type	100%	115%	125%	160%						
				W	H	D	A	Qty	Type	Qty	Type	100%	115%	125%	160%			
(3) 2 x 12	JUS210-3	LUS210-3	18	4-5/8	8-3/8	2	1	--	8	16d	6	16d	1845	2105	2290	2335	Blue	IBC, FL, LA
	SUH210-3	U210-3	16	4-5/8	8-3/8	2	1	--	14	10d 16d	6	10d	1750 1995	1965 1995	1995	1135	Grey	
	HD210-3	HU210-3	14	4-5/8	8-1/4	2-1/2	1-1/8	Min Max	14 20	16d	6 10	10d	2155 3080	2430 3475	2610 3725	1170 1950	Blue	
	HD210-3IF	HUC210-3	14	4-5/8	8-1/4	2-1/2	--	Min Max	14 20	16d	6 10	10d	2155 3080	2430 3475	2610 3725	1170 1950	Green	
	HDQ210-3IF	HUCQ210-3	14	4-5/8	9	3	1-1/2	--	12	WS3	6	WS3	5015	5590	5590	2975	Blue	
	HD212-3	HU212-3	14	4-5/8	10-1/4	2-1/2	1-1/8	Min Max	16 24	16d	8 12	10d	2465 3695	2780 4170	2980 4470	1305 2340	Blue	
	HD212-3IF	HUC212-3	14	4-5/8	10-1/4	2-1/2	--	Min Max	16 24	16d	8 12	10d	2465 3695	2780 4170	2980 4470	1305 2340	Green	
(3) 2 x 14	JUS210-3	LUS210-3	18	4-5/8	8-3/8	2	1	--	8	16d	6	16d	1845	2105	2290	2335	Blue	
	SUH210-3	U210-3	16	4-5/8	8-3/8	2	1	--	14	10d 16d	6	10d	1750 1995	1965 1995	1995	1135	Grey	
	HDQ210-3IF	HUCQ210-3	14	4-5/8	9	3	1-1/2	--	12	WS3	6	WS3	5015	5590	5590	2975	Blue	
	HD212-3	HU212-3	14	4-5/8	10-1/4	2-1/2	1-1/8	Min Max	16 24	16d	8 12	10d	2465 3695	2780 4170	2980 4470	1305 2340	Blue	
	HD212-3IF	HUC212-3	14	4-5/8	10-1/4	2-1/2	--	Min Max	16 24	16d	8 12	10d	2465 3695	2780 4170	2980 4470	1305 2340	Green	
	HD214-3	HU214-3	14	4-5/8	12-1/4	2-1/2	1-1/8	Min Max	18 26	16d	8 12	10d	2770 4005	3125 4515	3355 4845	1550 2340	Blue	
(3) 2 x 16	HD212-3	HU212-3	14	4-5/8	10-1/4	2-1/2	1-1/8	Min Max	16 24	16d	8 12	10d	2465 3695	2780 4170	2980 4470	1305 2340	Blue	
	HD212-3IF	HUC212-3	14	4-5/8	10-1/4	2-1/2	--	Min Max	16 24	16d	8 12	10d	2465 3695	2780 4170	2980 4470	1305 2340	Green	
	HD214-3	HU214-3	14	4-5/8	12-1/4	2-1/2	1-1/8	Min Max	18 26	16d	8 12	10d	2770 4005	3125 4515	3355 4845	1550 2340	Blue	
	HD216-3	HU216-3	14	4-5/8	13-1/4	2-1/2	1-1/8	Min Max	22 30	16d	10 14	10d	3390 4620	3820 5035	4100 5035	1950 2735	Blue	
(4) 2 x 8	HD28-4	HU28-4	14	6-1/8	7	2-1/2	1-3/4	Min Max	10 14	16d	4 6	16d	1540 2155	1735 2430	1865 2610	865 1305	Blue	
(4) 2 x 10	HD210-4	HU210-4	14	6-1/8	9-1/4	2-1/2	2	Min Max	14 18	16d	6 8	16d	2155 2770	2430 3125	2610 3355	1305 1845	Blue	
(4) 2 x 12	HD210-4	HU210-4	14	6-1/8	9-1/4	2-1/2	2	Min Max	14 18	16d	6 8	16d	2155 2770	2430 3125	2610 3355	1305 1845	Blue	
(4) 2 x 14	HD210-4	HU210-4	14	6-1/8	9-1/4	2-1/2	2	Min Max	14 18	16d	6 8	16d	2155 2770	2430 3125	2610 3355	1305 1845	Blue	
4 x 4	JUS44	LUS44	18	3-5/8	3-1/4	2	1	--	4	16d	2	16d	780	780	780	630	Green	
	SUH44	U44	16	3-9/16	2-7/8	2	1-1/8	--	6	10d 16d	2	10d	750 880	840 1000	910 1080	380	Grey	
	HD44	HU44	14	3-9/16	3-5/16	2-1/2	1-1/8	--	4	16d	2	10d	615	695	745	390	Blue	
	HD44IF	HUC44	14	3-9/16	3-5/16	2-1/2	--	--	4	16d	2	10d	615	695	745	390	Green	

1) Uplift loads have been increased 60% for wind or seismic loads; no further increase shall be permitted.  
 2) For JUS and HUS hangers: Nails must be driven at a 30° to 45° angle through the joist or truss into the header to achieve the table loads.  
 3) WS3 Wood Screws are 1/4" dia. x 3" long and are included with HDQ hangers.  
 4) **NAILS:** 10d nails are 0.148" dia. x 3" long, 16d nails are 0.162" dia. x 3-1/2" long.

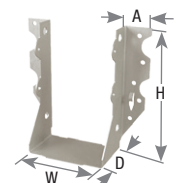
**Corrosion Finish** ■ Stainless Steel ■ Gold Coat ■ HDG ■ Triple Zinc



Joist Size	MiTek USP Stock No.	Ref. No.	Steel Gauge	Dimensions (in)				Fastener Schedule <sup>3,4</sup>				DF/SP Allowable Loads (Lbs.) <sup>2</sup>				Corrosion Finish	Code Ref.		
				W	H	D	A	Min/Max	Header		Joist		Floor		Roof			Uplift <sup>1</sup>	
									Qty	Type	Qty	Type	100%	115%	125%				160%
4 x 6	JUS46	LUS46	18	3-5/8	5	2	1	--	4	16d	4	16d	1040	1185	1290	1255			
	SUH46	U46	16	3-9/16	4-13/16	2	1-1/8	--	10	10d	4	10d	1250	1405	1515	755			
	HUS46	HUS46	14	3-5/8	5	2	1	--	4	16d	4	16d	1085	1235	1330	1070			
	HUS46IF	HUSC46	14	3-5/8	5	2	1	--	4	16d	4	16d	1085	1235	1330	1070			
	HD46	HU46	14	3-9/16	5-1/16	2-1/2	1-1/8	Min	8	16d	4	10d	1230	1390	1490	760			
								Max	12		6		1850	2085	2235	1170			
4 x 8	JUS46	LUS46	18	3-5/8	5	2	1	--	4	16d	4	16d	1040	1185	1290	1255			
	JUS48	LUS48	18	3-5/8	6-7/8	2	1	--	6	16d	4	16d	1325	1510	1645	1255			
	SUH46	U46	16	3-9/16	4-13/16	2	1-1/8	--	10	10d	4	10d	1250	1405	1515	755			
										16d			1470	1670	1800				
	HUS46	HUS46	14	3-5/8	5	2	1	--	4	16d	4	16d	1085	1235	1330	1070			
	HUS46IF	HUSC46	14	3-5/8	5	2	1	--	4	16d	4	16d	1085	1235	1330	1070			
	HUS48	HUS48	14	3-5/8	7	2	1	--	6	16d	6	16d	1625	1850	1865	2390			
	HUS48IF	HUSC48	14	3-5/8	7	2	1	--	6	16d	6	16d	1625	1850	1865	2390			
	HD46	HU46	14	3-9/16	5-1/16	2-1/2	1-1/8	Min	8	16d	4	10d	1230	1390	1490	760			
								Max	12		6		1850	2085	2235	1170			
	HD46IF	HUC46	14	3-9/16	5-1/16	2-1/2	--	Min	8	16d	4	10d	1230	1390	1490	760			
								Max	12		6		1850	2085	2235	1170			
4 x 10	HD48	HU48	14	3-9/16	6-15/16	2-1/2	1-1/8	Min	10	16d	4	10d	1540	1735	1865	780			
							Max	14		6		2155	2430	2610	1170				
	HD48IF	HUC48	14	3-9/16	6-15/16	2-1/2	--	Min	10	16d	4	10d	1540	1735	1865	780			
							Max	14		6		2155	2430	2610	1170				
	JUS48	LUS48	18	3-5/8	6-7/8	2	1	--	6	16d	4	16d	1325	1510	1645	1255			
	JUS410	LUS410	18	3-5/8	8-7/8	2	1	--	8	16d	6	16d	1845	2105	2290	2335			
	SUH410	U410	16	3-9/16	8-3/8	2	1-1/8	--	16	10d	6	10d	2000	2245	2420	1135			
										16d			2350	2670	2880				
	HUS48	HUS48	14	3-5/8	7	2	1	--	6	16d	6	16d	1625	1850	1865	2390			
	HUS48IF	HUSC48	14	3-5/8	7	2	1	--	6	16d	6	16d	1625	1850	1865	2390			
	HD410	HU410	14	3-9/16	8-13/16	2-1/2	1-1/8	Min	14	16d	6	10d	2155	2430	2610	1170			
								Max	20		10		3080	3475	3715	1950			
HD410IF	HUC410	14	3-9/16	8-13/16	2-1/2	--	Min	14	16d	6	10d	2155	2430	2610	1170				
							Max	20		10		3080	3475	3715	1950				
HDQ410IF	HUCQ410	14	3-9/16	9	3	1-1/2	--	12	WS3	6	WS3	5015	5590	5590	2975				

1) Uplift loads have been increased 60% for wind or seismic loads; no further increase shall be permitted.  
 2) For JUS and HUS hangers: Nails must be driven at a 30° to 45° angle through the joist or truss into the header to achieve the table loads.  
 3) WS3 Wood Screws are 1/4" dia. x 3" long and are included with HDQ hangers.  
 4) **NAILS:** 10d nails are 0.148" dia. x 3" long, 16d nails are 0.162" dia. x 3-1/2" long.

**Corrosion Finish** ■ Stainless Steel ■ Gold Coat ■ HDG ■ Triple Zinc



# Face Mount Hangers – DF/SP Allowable Loads

Joist Size	MiTek USP Stock No.	Ref. No.	Steel Gauge	Dimensions (in)				Fastener Schedule <sup>3,4</sup>				DF/SP Allowable Loads (Lbs.) <sup>2</sup>				Corrosion Finish	Code Ref.		
								Header		Joist		Allowable Loads (Lbs.) <sup>2</sup>							
				Min/Max	Qty	Type	Qty	Type	100%	115%	125%	160%	Uplift <sup>1</sup>						
4 x 12	JUS410	LUS410	18	3-5/8	8-7/8	2	1	--	8	16d	6	16d	1845	2105	2290	2335			
	SUH410	U410	16	3-9/16	8-3/8	2	1-1/8	--	16	10d	6	10d	2000	2245	2420	1135			
										16d			2350	2670	2880				
	HUS410	HUS410	14	3-5/8	8-7/8	2	1	--	8	16d	8	16d	2170	2465	2660	2390			
	HUS410IF	HUSC410	14	3-5/8	8-7/8	2	1	--	8	16d	8	16d	2170	2465	2660	2390			
	HD410	HU410	14	3-9/16	8-13/16	2-1/2	1-1/8	--	Min	14	16d	6	10d	2155	2430	2610	1170		
									Max	20		10		3080	3475	3715	1950		
	HD410IF	HUC410	14	3-9/16	8-13/16	2-1/2	--	Min	14	16d	6	10d	2155	2430	2610	1170			
								Max	20		10		3080	3475	3715	1950			
	HDQ410IF	HUCQ410	14	3-9/16	9	3	1-1/2	--	12	WS3	6	WS3	5015	5590	5590	2975			
	HUS412	HUS412	14	3-5/8	10-7/8	2	1	--	10	16d	10	16d	2710	3080	3325	3825			
	HUS412IF	HUSC412	14	3-5/8	10-7/8	2	1	--	10	16d	10	16d	2710	3080	3325	3825			
HD412	HU412	14	3-9/16	10-13/16	2-1/2	1-1/8	Min	16	16d	8	10d	2465	2780	2980	1305				
							Max	24		12		3695	4170	4470	2340				
HD412IF	HUC412	14	3-9/16	10-13/16	2-1/2	--	Min	16	16d	8	10d	2465	2780	2980	1305				
							Max	24		12		3695	4170	4470	2340				
HDQ412IF	HUCQ412	14	3-9/16	11	3	1-1/2	--	14	WS3	6	WS3	5605	5605	5605	3280				
4 x 14	JUS414	LUS414	18	3-5/8	12-7/8	2	1	--	12	16d	6	16d	2390	2390	2390	2335			
	SUH414	U414	16	3-9/16	10-1/16	2	1-1/8	--	18	10d	6	10d	2250	2525	2725	1135			
										16d			2645	3000	3240				
	HD410	HU410	14	3-9/16	8-13/16	2-1/2	1-1/8	Min	14	16d	6	10d	2155	2430	2610	1170			
								Max	20		10		3080	3475	3715	1950			
	HD410IF	HUC410	14	3-9/16	8-13/16	2-1/2	--	Min	14	16d	6	10d	2155	2430	2610	1170			
								Max	20		10		3080	3475	3715	1950			
	HDQ410IF	HUCQ410	14	3-9/16	9	3	1-1/2	--	12	WS3	6	WS3	5015	5590	5590	2975			
	HUS412	HUS412	14	3-5/8	10-7/8	2	1	--	10	16d	10	16d	2710	3080	3325	3825			
	HUS412IF	HUSC412	14	3-5/8	10-7/8	2	1	--	10	16d	10	16d	2710	3080	3325	3825			
	HDQ412IF	HUCQ412	14	3-9/16	11	3	1-1/2	--	14	WS3	6	WS3	5605	5605	5605	3280			
	HD412	HU412	14	3-9/16	10-13/16	2-1/2	1-1/8	Min	16	16d	8	10d	2465	2780	2980	1305			
Max								24	12		3695		4170	4470	2340				
HD412IF	HUC412	14	3-9/16	10-13/16	2-1/2	--	Min	16	16d	8	10d	2465	2780	2980	1305				
							Max	24		12		3695	4170	4470	2340				
HD414	HU414	14	3-9/16	12-13/16	2-1/2	1-1/8	Min	18	16d	8	10d	2770	3125	3355	1550				
							Max	26		12		4005	4515	4815	2340				
HD414IF	HUC414	14	3-9/16	12-13/16	2-1/2	--	Min	18	16d	8	10d	2770	3125	3355	1550				
							Max	26		12		4005	4515	4815	2340				
4 x 16	JUS414	LUS414	18	3-5/8	12-7/8	2	1	--	12	16d	6	16d	2390	2390	2390	2335			
	SUH414	U414	16	3-9/16	10-1/16	2	1-1/8	--	18	10d	6	10d	2250	2525	2725	1135			
										16d			2645	3000	3240				
	HD412	HU412	14	3-9/16	10-13/16	2-1/2	1-1/8	Min	16	16d	8	10d	2465	2780	2980	1305			
								Max	24		12		3695	4170	4470	2340			
	HD412IF	HUC412	14	3-9/16	10-13/16	2-1/2	--	Min	16	16d	8	10d	2465	2780	2980	1305			
								Max	24		12		3695	4170	4470	2340			
	HDQ412IF	HUCQ412	14	3-9/16	11	3	1-1/2	--	14	WS3	6	WS3	5605	5605	5605	3280			
	HD414	HU414	14	3-9/16	12-13/16	2-1/2	1-1/8	Min	18	16d	8	10d	2770	3125	3355	1550			
								Max	26		12		4005	4515	4815	2340			
	HD414IF	HUC414	14	3-9/16	12-13/16	2-1/2	--	Min	18	16d	8	10d	2770	3125	3355	1550			
								Max	26		12		4005	4515	4815	2340			
HD416	HU416	14	3-9/16	14-13/16	2-1/2	1-1/8	Min	22	16d	10	10d	3390	3820	4100	1950				
							Max	30		14		4620	4965	4965	2245				
HD416IF	HUC416	14	3-9/16	14-13/16	2-1/2	--	Min	22	16d	10	10d	3390	3820	4100	1950				
							Max	30		14		4620	4965	4965	2245				

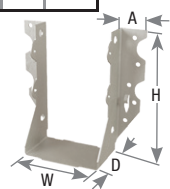
IBC, FL, LA

Hangers

Copyright © 2019 MiTek Industries, Inc. All Rights Reserved

1) Uplift loads have been increased 60% for wind or seismic loads; no further increase shall be permitted.  
 2) For JUS and HUS hangers: Nails must be driven at a 30° to 45° angle through the joist or truss into the header to achieve the table loads.  
 3) WS3 Wood Screws are 1/4" dia. x 3" long and are included with HDQ hangers.  
 4) NAILS: 10d nails are 0.148" dia. x 3" long, 16d nails are 0.162" dia. x 3-1/2" long.

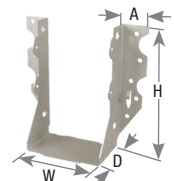
Corrosion Finish ■ Stainless Steel ■ Gold Coat ■ HDG ■ Triple Zinc



Joist Size	MiTek USP Stock No.	Ref. No.	Steel Gauge	Dimensions (in)				Fastener Schedule <sup>3</sup>				DF/SP Allowable Loads (Lbs.) <sup>2</sup>				Corrosion Finish	Code Ref.	
				W	H	D	A	Min/Max	Header		Joist		Floor	Roof				Uplift <sup>1</sup>
									Qty	Type	Qty	Type		100%	115%			
4 x 18	HD414	HU414	14	3-9/16	12-13/16	2-1/2	1-1/8	Min	18	16d	8	10d	2770	3125	3355	1550		
							Max	26	12		4005		4515	4815	2340			
	HD414IF	HUC414	14	3-9/16	12-13/16	2-1/2	--	Min	18	16d	8	10d	2770	3125	3355	1550		
							Max	26	12		4005		4515	4815	2340			
	HD416	HU416	14	3-9/16	14-13/16	2-1/2	1-1/8	Min	22	16d	10	10d	3390	3820	4100	1950		
						Max	30	14	4620		4965		4965	2245				
HD416IF	HUC416	14	3-9/16	14-13/16	2-1/2	--	Min	22	16d	10	10d	3390	3820	4100	1950			
						Max	30	14		4620		4965	4965	2245				
HD418	--	14	3-9/16	16-1/2	2-1/2	1-1/4	--	28	16d	8	10d	4310	4815	4815	1560			
6 x 6	SUH66	U66	16	5-1/2	5	2	1	--	8	10d	4	10d	1000	1120	1210	755		
									16d	6	16d	1175	1335	1440				
	HD66	HU66	14	5-1/2	4-1/16	2-1/2	1-1/8	Min	8	16d	4	16d	1230	1390	1490	865		
						Max	12	6	1850		2085		2235	1305				
HD66IF	HUC66	14	5-1/2	4-1/16	2-1/2	--	Min	8	16d	4	16d	1230	1390	1490	865			
						Max	12	6		1850		2085	2235	1305				
6 x 8	SUH66	U66	16	5-1/2	5	2	1	--	8	10d	4	10d	1000	1120	1210	755		
									16d	6	16d	1175	1335	1440				
	HD66	HU66	14	5-1/2	4-1/16	2-1/2	1-1/8	Min	8	16d	4	16d	1230	1390	1490	865		
							Max	12	6		1850		2085	2235	1305			
	HD66IF	HUC66	14	5-1/2	4-1/16	2-1/2	--	Min	8	16d	4	16d	1230	1390	1490	865		
						Max	12	6	1850		2085		2235	1305				
HD68	HU68	14	5-1/2	5-15/16	2-1/2	1-1/8	Min	10	16d	4	16d	1540	1735	1865	920			
						Max	14	6		2155		2430	2610	1305				
HD68IF	HUC68	14	5-1/2	5-15/16	2-1/2	--	Min	10	16d	4	16d	1540	1735	1865	920			
						Max	14	6		2155		2430	2610	1305				
6 x 10	SUH610	U610	16	5-1/2	9	2	1	--	14	10d	6	10d	1750	1965	2120	1135		
									16d	10	16d	2060	2335	2520				
	HD68	HU68	14	5-1/2	5-15/16	2-1/2	1-1/8	Min	10	16d	4	16d	1540	1735	1865	920		
							Max	14	6		2155		2430	2610	1305			
	HD68IF	HUC68	14	5-1/2	5-15/16	2-1/2	--	Min	10	16d	4	16d	1540	1735	1865	920		
							Max	14	6		2155		2430	2610	1305			
HD610	HU610	14	5-1/2	7-13/16	2-1/2	1-1/8	Min	14	16d	6	16d	2155	2430	2610	1305			
						Max	20	10		3080		3475	3725	2305				
HD610IF	HUC610	14	5-1/2	7-13/16	2-1/2	--	Min	14	16d	6	16d	2155	2430	2610	1305			
						Max	20	10		3080		3475	3725	2305				
HDQ610IF	HUCQ610	14	5-1/2	9	3	1-1/8	--	12	WS3	6	WS3	5015	5590	5590	2975			
6 x 12	SUH610	U610	16	5-1/2	9	2	1	--	14	10d	6	10d	1750	1965	2120	1135		
									16d	10	16d	2060	2335	2520				
	HD610	HU610	14	5-1/2	7-13/16	2-1/2	1-1/8	Min	14	16d	6	16d	2155	2430	2610	1305		
							Max	20	10		3080		3475	3725	2305			
	HD610IF	HUC610	14	5-1/2	7-13/16	2-1/2	--	Min	14	16d	6	16d	2155	2430	2610	1305		
							Max	20	10		3080		3475	3725	2305			
	HDQ610IF	HUCQ610	14	5-1/2	9	3	1-1/2	--	12	WS3	6	WS3	5015	5590	5590	2975		
HD612	HU612	14	5-1/2	9-13/16	2-1/2	1-1/8	Min	16	16d	8	16d	2465	2780	2980	1305			
						Max	24	12		3695		4170	4470	2765				
HD612IF	HUC612	14	5-1/2	9-13/16	2-1/2	--	Min	16	16d	8	16d	2465	2780	2980	1305			
						Max	24	12		3695		4170	4470	2765				
HDQ612IF	HUCQ612	14	5-1/2	11	3	1-1/2	--	14	WS3	6	WS3	5605	5605	5605	3280			

1) Uplift loads have been increased 60% for wind or seismic loads; no further increase shall be permitted.  
 2) WS3 Wood Screws are 1/4" dia. x 3" long and are included with HDQ hangers.  
 3) **NAILS:** 10d nails are 0.148" dia. x 3" long, 16d nails are 0.162" dia. x 3-1/2" long.

**Corrosion Finish** ■ Stainless Steel ■ Gold Coat ■ HDG ■ Triple Zinc

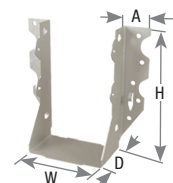


# Face Mount Hangers – DF/SP Allowable Loads

Joist Size	MiTek USP Stock No.	Ref. No.	Steel Gauge	Dimensions (in)				Fastener Schedule <sup>2,3</sup>				DF/SP Allowable Loads (Lbs.)				Corrosion Finish	Code Ref.	
				W	H	D	A	Min/Max	Header		Joist		Floor	Roof				Uplift <sup>1</sup>
									Qty	Type	Qty	Type		100%	115%			
6 x 14	HDQ610IF	HUCQ610	14	5-1/2	9	3	1-1/2	--	12	WS3	6	WS3	5015	5590	5590	2975	Blue	
	HD612	HU612	14	5-1/2	9-13/16	2-1/2	1-1/8	Min	16	16d	8	16d	2465	2780	2980	1305	Green	
								Max	24		12		3695	4170	4470	2765		
	HD612IF	HUC612	14	5-1/2	9-13/16	2-1/2	--	Min	16	16d	8	16d	2465	2780	2980	1305	Green	
								Max	24		12		3695	4170	4470	2765		
	HDQ612IF	HUCQ612	14	5-1/2	11	3	1-1/2	--	14	WS3	6	WS3	5605	5605	5605	3280	Blue	
HD614	HU614	14	5-1/2	11-13/16	2-1/2	1-1/8	Min	18	16d	8	16d	2770	3125	3355	1845	Green		
							Max	26		12		4005	4515	4845	2765			
HD614IF	HUC614	14	5-1/2	11-13/16	2-1/2	--	Min	18	16d	8	16d	2770	3125	3355	1845	Green		
							Max	26		12		4005	4515	4845	2765			
6 x 16	HD612	HU612	14	5-1/2	9-13/16	2-1/2	1-1/8	Min	16	16d	8	16d	2465	2780	2980	1305	Green	
								Max	24		12		3695	4170	4470	2765		
	HD612IF	HUC612	14	5-1/2	9-13/16	2-1/2	--	Min	16	16d	8	16d	2465	2780	2980	1305	Green	
								Max	24		12		3695	4170	4470	2765		
	HDQ612IF	HUCQ612	14	5-1/2	11	3	1-1/2	--	14	WS3	6	WS3	5605	5605	5605	3280	Blue	
	HD614	HU614	14	5-1/2	11-13/16	2-1/2	1-1/8	Min	18	16d	8	16d	2770	3125	3355	1845	Green	
								Max	26		12		4005	4515	4845	2765		
HD614IF	HUC614	14	5-1/2	11-13/16	2-1/2	--	Min	18	16d	8	16d	2770	3125	3355	1845	Green		
							Max	26		12		4005	4515	4845	2765			
HD616	HU616	14	5-1/2	13-13/16	2-1/2	1-1/8	Min	22	16d	10	16d	3390	3820	4100	2305	Green	IBC, FL, LA	
							Max	30		14		4620	4965	4965	3225			
HD616IF	HUC616	14	5-1/2	13-13/16	2-1/2	--	Min	22	16d	10	16d	3390	3820	4100	2305	Green		
							Max	30		14		4620	4965	4965	3225			
6 x 18	HD614	HU614	14	5-1/2	11-13/16	2-1/2	1-1/8	Min	18	16d	8	16d	2770	3125	3355	1845	Green	
								Max	26		12		4005	4515	4845	2765		
	HD614IF	HUC614	14	5-1/2	11-13/16	2-1/2	--	Min	18	16d	8	16d	2770	3125	3355	1845	Green	
								Max	26		12		4005	4515	4845	2765		
HD616	HU616	14	5-1/2	13-13/16	2-1/2	1-1/8	Min	22	16d	10	16d	3390	3820	4100	2305	Green		
							Max	30		14		4620	4965	4965	3225			
HD616IF	HUC616	14	5-1/2	13-13/16	2-1/2	--	Min	22	16d	10	16d	3390	3820	4100	2305	Green		
							Max	30		14		4620	4965	4965	3225			
8 x 6	HD86	--	14	7-1/2	4-15/16	2-1/2	1-1/2	Min	8	16d	4	16d	1230	1390	1490	865	Green	
								Max	10		4		1540	1735	1865	920		
HD86IF	--	14	7-1/2	5-1/8	2-1/2	--	--	10	16d	4	16d	1540	1735	1865	920	Green		
8 x 8	HD88	HU88	14	7-1/2	6-13/16	2-1/2	1-1/2	Min	10	16d	4	16d	1540	1735	1865	920	Green	
								Max	14		6		2155	2430	2610	1305		
	HD88IF	HUC88	14	7-1/2	6-13/16	2-1/2	--	Min	10	16d	4	16d	1540	1735	1865	920	Green	
								Max	14		6		2155	2430	2610	1305		

1) Uplift loads have been increased 60% for wind or seismic loads; no further increase shall be permitted.  
 2) WS3 Wood Screws are 1/4" dia. x 3" long and are included with HDQ hangers.  
 3) **NAILS:** 10d x 1-1/2 nails are 0.148" dia. x 1-1/2" long, 10d nails are 0.148" dia. x 3" long, 16d nails are 0.162" dia. x 3-1/2" long.

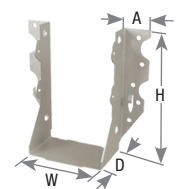
Corrosion Finish ■ Stainless Steel ■ Gold Coat ■ HDG ■ Triple Zinc





Joist Size	MiTek USP Stock No.	Ref. No.	Steel Gauge	Dimensions (in)				Fastener Schedule <sup>2</sup>				DF/SP Allowable Loads (Lbs.)				Code Ref.	
				W	H	D	A	Min/Max	Header		Joist		DF/SP Allowable Loads (Lbs.)				
									Qty	Type	Qty	Type	Floor	Roof			Uplift <sup>1</sup>
100%	115%	125%	160%														
8 x 10	HD810	HU810	14	7-1/2	8-9/16	2-1/2	1-1/2	Min	14	16d	6	16d	2155	2430	2610	1305	IBC, FL, LA
								Max	18		8		2770	3125	3355	1845	
	HD810IF	HUC810	14	7-1/2	8-9/16	2-1/2	--	Min	14	16d	6	16d	2155	2430	2610	1305	
								Max	18		8		2770	3125	3355	1845	
8 x 12	HD812	HU812	14	7-1/2	10-1/2	2-1/2	1-1/2	Min	16	16d	6	16d	2465	2780	2980	1305	
								Max	22		8		3390	3820	4100	1845	
	HD812IF	HUC812	14	7-1/2	10-1/2	2-1/2	--	Min	16	16d	6	16d	2465	2780	2980	1305	
								Max	22		8		3390	3820	4100	1845	
8 x 14	HD814	HU814	14	7-1/2	11-13/16	2-1/2	1-1/2	Min	18	16d	8	16d	2770	3125	3355	1845	
								Max	24		12		3695	4170	4435	2765	
	HD814IF	HUC814	14	7-1/2	11-13/16	2-1/2	--	Min	18	16d	8	16d	2770	3125	3355	1845	
								Max	24		12		3695	4170	4435	2765	
8 x 16	HD816	HU816	14	7-1/2	12-13/16	2-1/2	1-1/2	Min	20	16d	8	16d	3080	3475	3715	1845	
								Max	26		12		4005	4435	4435	2765	
	HD816IF	HUC816	14	7-1/2	13-5/8	2-1/2	--	Min	26	16d	12	16d	4005	4435	4435	2765	
								Max	26		12		4005	4435	4435	2765	
<b>ROUGH LUMBER SIZES</b>																	
2 x 4	SUH24R	LU24R-18, U24R	16	2	3-1/16	2	1-1/8	--	4	10d	2	10d x 1-1/2	500	560	605	380	IBC, FL, LA
										16d			590	665	720		
2 x 6 - 8	SUH26R	LU26R-18, U26R	16	2	4-15/16	2	1-3/16	--	6	10d	4	10d x 1-1/2	750	840	910	755	
										16d			880	1000	1080		
2 x 8 - 10	SUH28R	LU28R-18	16	2	6-7/16	2	1-1/8	--	8	10d	6	10d x 1-1/2	1000	1120	1210	830	
										16d			1175	1335	1440		
2 x 10 - 12	SUH210R	LU210R-18, U210R	16	2	7-13/16	2	1-1/8	--	10	10d	6	10d x 1-1/2	1250	1405	1515	1135	
										16d			1470	1670	1800		
2 x 14 - 16	SUH214R	--	16	2	9-13/16	2	1-1/8	--	12	10d	8	10d x 1-1/2	1500	1685	1815	1510	
										16d			1765	2000	2160		
4 x 4	SUH44R	U44R	16	4	2-11/16	2	1-1/8	--	6	10d	2	16d	750	840	910	445	
										16d			880	1000	1080		
4 x 6	SUH46R	U46R	16	4	4-11/16	2	1-1/8	--	8	10d	4	16d	1000	1120	1210	830	
										16d			1175	1335	1440		
4 x 10 - 12	SUH410R	U410R	16	4	8-3/16	2	2	--	14	10d	6	16d	1750	1965	2120	1220	
										16d			2060	2335	2520		
6 x 8	SUH66R	U66R	16	6	5	2	1	--	8	10d	4	16d	1000	1120	1210	830	
										16d			1175	1335	1440		
6 x 10 - 12 - 14	SUH610R	U610R	16	6	9	2	1	--	14	10d	6	16d	1750	1965	2120	1220	
										16d			2060	2335	2520		
<b>GLULAM SIZES</b>																	
3-1/8 x 10-1/2 - 19-1/2	HD32105	HU3.25/10.5	14	3-1/4	9-15/16	2-1/2	1-1/8	Min	16	16d	6	10d	2465	2780	2980	1170	IBC, FL, LA
								Max	22		10		3390	3820	4100	1950	
3-1/8 x 12 - 21	HD3212	HU3.25/12	14	3-1/4	11-7/8	2-1/2	1-1/8	Min	18	16d	8	10d	2770	3125	3355	1550	
								Max	26		12		4005	4515	4845	2340	
5-1/8 x 10-1/2 - 19-1/2	HD5112	HU5.125/12	14	5-1/4	9-15/16	2-1/2	1-1/8	Min	16	16d	8	16d	2465	2780	2980	1305	
								Max	24		12		3695	4170	4470	2765	
5-1/8 x 14-1/2 - 21	HD51135	HU5.125/13.5	14	5-1/4	12-15/16	2-1/2	1-1/8	Min	20	16d	10	16d	3080	3475	3715	2305	
								Max	28		14		4310	4860	5035	3225	

1) Uplift loads have been increased 60% for wind or seismic loads; no further increase shall be permitted.  
 2) **NAILS:** 10d x 1-1/2 nails are 0.148" dia. x 1-1/2" long, 10d nails are 0.148" dia. x 3" long, 16d nails are 0.162" dia. x 3-1/2" long.



Copyright © 2019 MiTek Industries, Inc. All Rights Reserved

Hangers

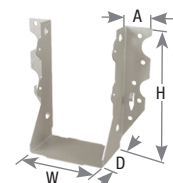
# Face Mount Hangers – SPF Allowable Loads

Joist Size	MiTek USP Stock No.	Ref. No.	Steel Gauge	Dimensions (in)				Fastener Schedule <sup>3</sup>				SPF Allowable Loads (Lbs.) <sup>2</sup>				Corrosion Finish	Code Ref.		
				W	H	D	A	Min/Max	Header		Joist		Floor		Roof			Uplift <sup>1</sup>	
									Qty	Type	Qty	Type	100%	115%	125%				160%
2 x 4	JL24	LU24	20	1-9/16	3	1-1/2	15/16	--	4	10d 16d	2	10d x 1-1/2	415 495	475 540	510 540	235			
	JL24IF-TZ	--	18	1-9/16	3-1/8	1-1/2	--	--	4	10d HDG 16d HDG	2	10d x 1-1/2 HDG	405 475	460 475	475 475	215			
	JUS24	LUS24	18	1-9/16	3-1/8	1-3/4	1	--	4	10d	2	10d	595	680	735	500			
	SUH24	U24	16	1-9/16	3-1/4	2	1-3/16	--	4	10d 16d	2	10d x 1-1/2	440 515	495 585	530 635	310			
	HD26	HU26	14	1-9/16	3-1/2	2-1/2	1-1/8	Min Max	4	16d	2 4	10d x 1-1/2	540	610	655	265 465			
2 x 6	JL26	LU26	20	1-9/16	4-3/4	1-1/2	15/16	--	6	10d 16d	4	10d x 1-1/2	625 740	710 845	765 915	485			
	JL26IF-TZ	LUC26Z	18	1-9/16	4-1/2	1-1/2	--	--	6	10d HDG 16d HDG	4	10d x 1-1/2 HDG	640 765	730 870	790 945	660			
	JUS26	LUS26	18	1-9/16	4-13/16	1-3/4	1	--	4	10d	4	10d	765	880	950	800			
	MUS26	MUS26	18	1-9/16	5-1/16	2	1	--	6	10d	6	10d	1190	1365	1475	760			
	SUH26	U26	16	1-9/16	5-1/8	2	1-3/16	--	6	10d 16d	4	10d x 1-1/2	660 775	740 880	800 950	665			
	HUS26	HUS26	16	1-5/8	5-7/16	3	2	--	14	16d	6	16d	2430	2765	2990	1630			
	HD26	HU26	14	1-9/16	3-1/2	2-1/2	1-1/8	Min Max	4	16d	2 4	10d x 1-1/2	540	610	655	265 465			
	HD28	HU28	14	1-9/16	5-1/4	2-1/2	1-1/8	--	8	16d	<b>6</b>	10d x 1-1/2	1085	1220	1310	610			
2 x 8	JL26	LU26	20	1-9/16	4-3/4	1-1/2	15/16	--	6	10d 16d	4	10d x 1-1/2	625 740	710 845	765 915	485			
	JL26IF-TZ	LUC26Z	18	1-9/16	4-1/2	1-1/2	--	--	6	10d HDG 16d HDG	4	10d x 1-1/2 HDG	640 765	730 870	790 945	660			
	JL28	LU28	20	1-9/16	6-3/8	1-1/2	15/16	--	10	10d 16d	6	10d x 1-1/2	1040 1230	1185 1405	1275 1530	650			
	JL28IF-TZ	--	18	1-9/16	6-1/8	1-1/2	--	--	8	10d HDG 16d HDG	4	10d x 1-1/2 HDG	855 1020	975 1035	1035 1035	660			
	JUS26	LUS26	18	1-9/16	4-13/16	1-3/4	1	--	4	10d	4	10d	765	880	950	800			
	JUS28	LUS28	18	1-9/16	6-5/8	1-3/4	1	--	6	10d	4	10d	980	1120	1210	800			
	MUS26	MUS26	18	1-9/16	5-1/16	2	1	--	6	10d	6	10d	1190	1365	1475	760			
	MUS28	MUS28	18	1-9/16	7-1/16	2	1	--	8	10d	8	10d	1585	1815	1965	1085			
	SUH26	U26	16	1-9/16	5-1/8	2	1-3/16	--	6	10d 16d	4	10d x 1-1/2	660 775	740 880	800 950	665			
	SUH28	--	16	1-9/16	6-5/8	2	1-3/16	--	8	10d 16d	6	10d x 1-1/2	880 1035	990 1175	1065 1265	670			
	HUS26	HUS26	16	1-5/8	5-7/16	3	2	--	14	16d	6	16d	2430	2765	2990	1630			
	HUS28	HUS28	16	1-5/8	7-3/16	3	2	--	22	16d	8	16d	3670	4035	4105	2380			
	HD28	HU28	14	1-9/16	5-1/4	2-1/2	1-1/8	--	8	16d	<b>6</b>	10d x 1-1/2	1085	1220	1310	610			
HD210	HU210	14	1-9/16	7-3/16	2-1/2	1-1/8	Min Max	10 14	16d	4 6	10d x 1-1/2	1355 1895	1525 2140	1640 2295	610 950				

IBC, FL, LA

1) Uplift loads have been increased 60% for wind or seismic loads; no further increase shall be permitted.  
 2) For JUS, HUS, and MUS hangers: Nails must be driven at a 30° to 45° angle through the joist or truss into the header to achieve the table loads.  
 3) **NAILS:** 10d x 1-1/2 nails are 0.148" dia. x 1-1/2" long, 10d nails are 0.148" dia. x 3" long, 16d nails are 0.162" dia. x 3-1/2" long.  
 New products or updated product information are designated in **blue font**.

**Corrosion Finish** ■ Stainless Steel ■ Gold Coat ■ HDG ■ Triple Zinc



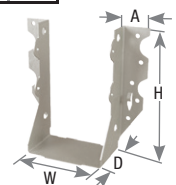
Joist Size	MiTek USP Stock No.	Ref. No.	Steel Gauge	Dimensions (in)				Fastener Schedule <sup>3</sup>				SPF Allowable Loads (Lbs.) <sup>2</sup>				Corrosion Finish	Code Ref.		
				W	H	D	A	Min/Max	Header		Joist		Allowable Loads (Lbs.) <sup>2</sup>						
									Qty	Type	Qty	Type	Floor	Roof	Uplift <sup>1</sup>				
100%	115%	125%	160%																
2 x 10	JL28	LU28	20	1-9/16	6-3/8	1-1/2	15/16	--	10	10d	6	10d x 1-1/2	1040	1185	1275	650			
										16d			1230	1405	1530				
	JL28IF-TZ	--	18	1-9/16	6-1/8	1-1/2	--	--	8	10d HDG	4	10d x 1-1/2 HDG	855	975	1035	660			
										16d HDG			1020	1035	1035				
	JL210	LU210	20	1-9/16	8-1/4	1-1/2	15/16	--	14	10d	8	10d x 1-1/2	1455	1590	1590	830			
										16d			1590	1590	1590				
	JL210IF-TZ	LUC210Z	18	1-9/16	8-1/4	1-1/2	--	--	11	10d HDG	6	10d x 1-1/2 HDG	1175	1345	1445	995			
										16d HDG			1405	1590	1730				
	JUS28	LUS28	18	1-9/16	6-5/8	1-3/4	1	--	6	10d	4	10d	980	1120	1210	800			
	JUS210	LUS210	18	1-9/16	7-3/4	1-3/4	1	--	8	10d	4	10d	1190	1360	1395	800			
	MUS28	MUS28	18	1-9/16	7-1/16	2	1	--	8	10d	8	10d	1585	1815	1965	1085			
SUH28	--	16	1-9/16	6-5/8	2	1-3/16	--	8	10d	6	10d x 1-1/2	880	990	1065	670				
									16d			1035	1175	1265					
SUH210	U210	16	1-9/16	8	2	1-3/16	--	10	10d	6	10d x 1-1/2	1100	1235	1330	990				
									16d			1295	1465	1585					
HUS28	HUS28	16	1-5/8	7-3/16	3	2	--	22	16d	8	16d	3670	4035	4105	2380				
HUS210	HUS210	16	1-5/8	9-3/16	3	2	--	30	16d	10	16d	4235	4565	4780	3390				
HD210	HU210	14	1-9/16	7-3/16	2-1/2	1-1/8	Min	10	16d	4	10d x 1-1/2	1355	1525	1640	610				
								Max				14	6	1895	2140			2295	950
2 x 12	JL210	LU210	20	1-9/16	8-1/4	1-1/2	15/16	--	14	10d	8	10d x 1-1/2	1455	1590	1590	830			
									16d			1590	1590	1590					
	JL210IF-TZ	LUC210Z	18	1-9/16	8-1/4	1-1/2	--	--	11	10d HDG	6	10d x 1-1/2 HDG	1175	1345	1445	995			
										16d HDG			1405	1590	1730				
	JUS210	LUS210	18	1-9/16	7-3/4	1-3/4	1	--	8	10d	4	10d	1190	1360	1395	800			
	SUH210	U210	16	1-9/16	8	2	1-3/16	--	10	10d	6	10d x 1-1/2	1100	1235	1330	990		IBC, FL, LA	
										16d			1295	1465	1585				
HUS210	HUS210	16	1-5/8	9-3/16	3	2	--	30	16d	10	16d	4235	4565	4780	3390				
HD210	HU210	14	1-9/16	7-3/16	2-1/2	1-1/8	Min	10	16d	4	10d x 1-1/2	1355	1525	1640	610				
								Max				14	6	1895	2140			2295	950
HD212	HU212	14	1-9/16	9-1/4	2-1/2	1-1/8	Min	14	16d	6	10d x 1-1/2	1895	2140	2295	950				
								Max				20	10	2710	2900			2990	1260
HD212IF	HUC212	14	1-9/16	9-1/4	2	--	--	16	16d	8	10d x 1-1/2	2165	2320	2390	960				
2 x 14	SUH214	U214	16	1-9/16	10	2	1-1/8	--	12	10d	8	10d x 1-1/2	1320	1480	1595	1330			
									16d			1550	1760	1900					
	HD212	HU212	14	1-9/16	9-1/4	2-1/2	1-1/8	Min	14	16d	6	10d x 1-1/2	1895	2140	2295	950			
									Max				20	10	2710	2900			2990
HD212IF	HUC212	14	1-9/16	9-1/4	2	--	--	16	16d	8	10d x 1-1/2	2165	2320	2390	960				
HD214	HU214	14	1-9/16	10-13/16	2-1/2	1-1/8	Min	16	16d	8	10d x 1-1/2	2165	2445	2620	955				
								Max				24	12	2985	3160			3270	1265
2 x 16	SUH214	U214	16	1-9/16	10	2	1-1/8	--	12	10d	8	10d x 1-1/2	1320	1480	1595	1330			
									16d			1550	1760	1900					
	HD212	HU212	14	1-9/16	9-1/4	2-1/2	1-1/8	Min	14	16d	6	10d x 1-1/2	1895	2140	2295	950			
									Max				20	10	2710	2900			2990
	HD212IF	HUC212	14	1-9/16	9-1/4	2	--	--	16	16d	8	10d x 1-1/2	2165	2320	2390	960			
HD214	HU214	14	1-9/16	10-13/16	2-1/2	1-1/8	Min	16	16d	8	10d x 1-1/2	2165	2445	2620	955				
								Max				24	12	2985	3160			3270	1265
HD216	HU216	14	1-9/16	12-3/4	2-1/2	1-1/8	Min	18	16d	8	10d x 1-1/2	2440	2640	2710	1255				
								Max				26	12	2985	3160			3270	1550

Copyright © 2019 MiTek Industries, Inc. All Rights Reserved

Hangers

1) Uplift loads have been increased 60% for wind or seismic loads; no further increase shall be permitted.  
 2) For JUS, HUS, and MUS hangers: Nails must be driven at a 30° to 45° angle through the joist or truss into the header to achieve the table loads.  
 3) **NAILS:** 10d x 1-1/2 nails are 0.148" dia. x 1-1/2" long, 10d nails are 0.148" dia. x 3" long, 16d nails are 0.162" dia. x 3-1/2" long.  
 New products or updated product information are designated in **blue font**.

**Corrosion Finish** ■ Stainless Steel ■ Gold Coat ■ HDG ■ Triple Zinc

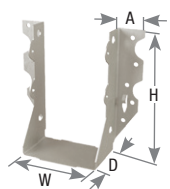


Joist Size	MiTek USP Stock No.	Ref. No.	Steel Gauge	Dimensions (in)				Fastener Schedule <sup>3,4</sup>				SPF Allowable Loads (Lbs.) <sup>2</sup>				Corrosion Finish	Code Ref.		
				W	H	D	A	Min/Max	Header		Joist		Floor		Roof			Uplift <sup>1</sup>	
									Qty	Type	Qty	Type	100%	115%	125%				160%
(2) 2 x 4	JUS24-2	LUS24-2	18	3-1/8	3-7/16	2	1	--	4	16d	2	16d	710	715	715	500			
	SUH24-2	U24-2	16	3-1/8	3-1/8	2	1-1/8	--	6	10d 16d	2	10d	660 775	740 880	800 950	330			
	HD24-2	HU24-2	14	3-1/8	3-1/2	2-1/2	1-1/8	--	4	16d	2	10d	540	610	655	290			
	HUS24-2	--	14	3-1/8	3-7/16	2	1	--	4	16d	2	16d	750	820	820	600			
	HUS24-2IF	--	14	3-1/8	3-7/16	2	1	--	4	16d	2	16d	750	820	820	600			
(2) 2 x 6	JUS26-2	LUS26-2	18	3-1/8	5-1/4	2	1	--	4	16d	4	16d	915	1045	1135	1000			
	SUH26-2	U26-2	16	3-1/8	5-1/16	2	1-1/8	--	10	10d 16d	4	10d	1100 1295	1235 1465	1330 1585	660			
	HD24-2	HU24-2	14	3-1/8	3-1/2	2-1/2	1-1/8	--	4	16d	2	10d	540	610	655	290			
	HUS26-2	HUS26-2	14	3-1/8	5-1/4	2	1	--	4	16d	4	16d	910	1035	1115	780			
	HUS26-2IF	HUSC26-2	14	3-1/8	5-1/4	2	1	--	4	16d	4	16d	955	1085	1170	850			
	HD26-2	HU26-2	14	3-1/8	5-1/4	2-1/2	1-1/8	Min	8	16d	4	10d	1085	1220	1310	605			
							Max	12	6				1625	1835	1965	1030			
	HD26-2IF	HUC26-2	14	3-1/8	5-1/4	2-1/2	--	Min	8	16d	4	10d	1085	1220	1310	605			
							Max	12	6				1625	1835	1965	1030			
(2) 2 x 8	JUS26-2	LUS26-2	18	3-1/8	5-1/4	2	1	--	4	16d	4	16d	915	1045	1135	1000			
	JUS28-2	LUS28-2	18	3-1/8	7-1/8	2	1	--	6	16d	4	16d	1165	1330	1445	1000			
	SUH26-2	U26-2	16	3-1/8	5-1/16	2	1-1/8	--	10	10d 16d	4	10d	1100 1295	1235 1465	1330 1585	660			
	SUH28-2	--	16	3-1/8	6-1/4	2	1-1/8	--	12	10d 16d	4	10d	1320 1550	1480 1585	1585	660			
	HUS26-2	HUS26-2	14	3-1/8	5-1/4	2	1	--	4	16d	4	16d	910	1035	1115	780			
	HUS26-2IF	HUSC26-2	14	3-1/8	5-1/4	2	1	--	4	16d	4	16d	955	1085	1170	850			
	HUS28-2	HUS28-2	14	3-1/8	7-1/8	2	1	--	6	16d	6	16d	1430	1495	1495	1910			
	HUS28-2IF	HUSC28-2	14	3-1/8	7-1/8	2	1	--	6	16d	6	16d	1430	1495	1495	1910			
	HD26-2	HU26-2	14	3-1/8	5-1/4	2-1/2	1-1/8	Min	8	16d	4	10d	1085	1220	1310	605			
							Max	12	6				1625	1835	1965	1030			
		HD26-2IF	HUC26-2	14	3-1/8	5-1/4	2-1/2	--	Min	8	16d	4	10d	1085	1220	1310	605		
							Max	12	6	1625				1835	1965	1030			
	HD28-2	HU28-2	14	3-1/8	7-1/8	2-1/2	1-1/8	Min	10	16d	4	10d	1355	1525	1640	685			
							Max	14	6				1895	2140	2295	1030			
	HD28-2IF	HUC28-2	14	3-1/8	7-1/8	2-1/2	--	Min	10	16d	4	10d	1355	1525	1640	685			
							Max	14	6				1895	2140	2295	1030			
(2) 2 x 10	JUS28-2	LUS28-2	18	3-1/8	7-1/8	2	1	--	6	16d	4	16d	1165	1330	1445	1000			
	JUS210-2	LUS210-2	18	3-1/8	9-1/8	2	1	--	8	16d	6	16d	1625	1850	1910	1865			
	SUH28-2	--	16	3-1/8	6-1/4	2	1-1/8	--	12	10d 16d	4	10d	1320 1550	1480 1585	1585	660			
	SUH210-2	U210-2	16	3-1/8	8-9/16	2	1-1/8	--	16	10d 16d	6	10d	1760 2070	1975 2345	2130 2535	975			
	HUS28-2	HUS28-2	14	3-1/8	7-1/8	2	1	--	6	16d	6	16d	1430	1495	1495	1910			
	HUS28-2IF	HUSC28-2	14	3-1/8	7-1/8	2	1	--	6	16d	6	16d	1430	1495	1495	1910			
	HD28-2	HU28-2	14	3-1/8	7-1/8	2-1/2	1-1/8	Min	10	16d	4	10d	1355	1525	1640	685			
							Max	14	6				1895	2140	2295	1030			
		HD28-2IF	HUC28-2	14	3-1/8	7-1/8	2-1/2	--	Min	10	16d	4	10d	1355	1525	1640	685		
								Max	14	6				1895	2140	2295	1030		
		HUS210-2	HUS210-2	14	3-1/8	9-1/8	2	1	--	8	16d	8	16d	1905	2170	2325	1920		
		HUS210-2IF	HUSC210-2	14	3-1/8	9-1/8	2	1	--	8	16d	8	16d	1905	2170	2325	1920		
		HD210-2	HU210-2	14	3-1/8	9	2-1/2	1-1/8	Min	14	16d	6	10d	1895	2140	2295	1030		
							Max	20	10	2710				2975	2975	1715			
	HD210-2IF	HUC210-2	14	3-1/8	9	2-1/2	--	Min	14	16d	6	10d	1895	2140	2295	1030			
							Max	20	10				2710	2975	2975	1715			
	HDQ210-2IF	HUCQ210-2	14	3-1/4	9	3	1-1/2	--	12	WS3	6	WS3	4670	4910	4910	2870			

IBC, FL, LA

1) Uplift loads have been increased 60% for wind or seismic loads; no further increase shall be permitted.  
 2) For JUS and HUS hangers: Nails must be driven at a 30° to 45° angle through the joist or truss into the header to achieve the table loads.  
 3) WS3 Wood Screws are 1/4" x 3" long and are included with HDQ hangers.  
 4) **NAILS:** 10d nails are 0.148" dia. x 3" long, 16d are 0.162" dia. x 3-1/2" long.

**Corrosion Finish** ■ Stainless Steel ■ Gold Coat ■ HDG ■ Triple Zinc



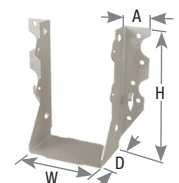
Joist Size	MiTek USP Stock No.	Ref. No.	Steel Gauge	Dimensions (in)				Fastener Schedule <sup>3,4</sup>				SPF Allowable Loads (Lbs.) <sup>2</sup>				Corrosion Finish	Code Ref.		
				W	H	D	A	Min/Max	Header		Joist		Floor		Roof			Uplift <sup>1</sup>	
									Qty	Type	Qty	Type	100%	115%	125%				160%
(2) 2 x 12	JUS210-2	LUS210-2	18	3-1/8	9-1/8	2	1	--	8	16d	6	16d	1625	1850	1910	1865	Green	IBC, FL, LA	
	SUH210-2	U210-2	16	3-1/8	8-9/16	2	1-1/8	--	16	10d	6	10d	1760	1975	2130	975	Green		
										16d			2070	2345	2535				
	HUS210-2	HUS210-2	14	3-1/8	9-1/8	2	1	--	8	16d	8	16d	1905	2170	2325	1920	Green		
	HUS210-2IF	HUSC210-2	14	3-1/8	9-1/8	2	1	--	8	16d	8	16d	1905	2170	2325	1920	Green		
	HD210-2	HU210-2	14	3-1/8	9	2-1/2	1-1/8	Min	14	16d	6	10d	1895	2140	2295	1030	Green		
									20				2710	2975	2975	1715			
	HD210-2IF	HUC210-2	14	3-1/8	9	2-1/2	--	Min	14	16d	6	10d	1895	2140	2295	1030	Green		
									20				2710	2975	2975	1715			
	HUS212-2	HUS212-2	14	3-1/8	11-1/8	2	1	--	10	16d	10	16d	2385	2710	2840	3090	Blue		
HUS212-2IF	HUSC212-2	14	3-1/8	11-1/8	2	--	--	10	16d	10	16d	2385	2710	2840	3090	Blue			
HD212-2	HU212-2	14	3-1/8	11	2-1/2	1-1/8	Min	16	16d	8	10d	2165	2445	2620	1045	Green			
								24				3250	3665	3865	2060				
HD212-2IF	HUC212-2	14	3-1/8	11	2-1/2	--	Min	16	16d	8	10d	2165	2445	2620	1045	Green			
								24				3250	3665	3865	2060				
HDQ210-2IF	HUCQ210-2	14	3-1/4	9	3	1-1/2	--	12	WS3	6	WS3	4670	4910	4910	2870	Blue			
(2) 2 x 14	JUS210-2	LUS210-2	18	3-1/8	9-1/8	2	1	--	8	16d	6	16d	1625	1850	1910	1865	Green	IBC, FL, LA	
	JUS214-2	LUS214-2	18	3-1/8	13-1/8	2	1	--	12	16d	6	16d	2125	2260	2260	1865	Green		
	SUH210-2	U210-2	16	3-1/8	8-9/16	2	1-1/8	--	16	10d	6	10d	1760	1975	2130	975	Green		
										16d			2070	2345	2535				
	HD210-2	HU210-2	14	3-1/8	9	2-1/2	1-1/8	Min	14	16d	6	10d	1895	2140	2295	1030	Green		
									20				2710	2975	2975	1715			
	HD210-2IF	HUC210-2	14	3-1/8	9	2-1/2	--	Min	14	16d	6	10d	1895	2140	2295	1030	Green		
									20				2710	2975	2975	1715			
	HUS210-2	HUS210-2	14	3-1/8	9-1/8	2	1	--	8	16d	8	16d	1905	2170	2325	1920	Green		
	HUS210-2IF	HUSC210-2	14	3-1/8	9-1/8	2	1	--	8	16d	8	16d	1905	2170	2325	1920	Green		
HUS212-2	HUS212-2	14	3-1/8	11-1/8	2	1	--	10	16d	10	16d	2385	2710	2840	3090	Blue			
HUS212-2IF	HUSC212-2	14	3-1/8	11-1/8	2	1	--	10	16d	10	16d	2385	2710	2840	3090	Blue			
HD212-2	HU212-2	14	3-1/8	11	2-1/2	1-1/8	Min	16	16d	8	10d	2165	2445	2620	1045	Green			
								24				3250	3665	3865	2060				
HD212-2IF	HUC212-2	14	3-1/8	11	2-1/2	--	Min	16	16d	8	10d	2165	2445	2620	1045	Green			
								24				3250	3665	3865	2060				
HD214-2	HU214-2	14	3-1/8	13	2-1/2	1-1/8	Min	18	16d	8	10d	2440	2750	2950	1240	Green			
								26				3520	3970	4045	2060				
HDQ210-2IF	HUCQ210-2	14	3-1/4	9	3	1-1/2	--	12	WS3	6	WS3	4670	4910	4910	2870	Blue			
(2) 2 x 16	JUS214-2	LUS214-2	18	3-1/8	13-1/8	2	1	--	12	16d	6	16d	2125	2260	2260	1865	Green	IBC, FL, LA	
	HD212-2	HU212-2	14	3-1/8	11	2-1/2	1-1/8	Min	16	16d	8	10d	2165	2445	2620	1045	Green		
									24				3250	3665	3865	2060			
	HD212-2IF	HUC212-2	14	3-1/8	11	2-1/2	--	Min	16	16d	8	10d	2165	2445	2620	1045	Green		
									24				3250	3665	3865	2060			
HD214-2	HU214-2	14	3-1/8	13	2-1/2	1-1/8	Min	18	16d	8	10d	2440	2750	2950	1240	Green			
								26				3520	3970	4045	2060				
HD216-2	HU216-2	14	3-1/8	14	2-1/2	1-1/8	Min	22	16d	10	10d	2980	3360	3605	1715	Green			
								30				4060	4060	4060	2405				
3 x 4	SUH34	U34	16	2-9/16	3-3/8	2	1-1/8	--	6	10d	2	10d x 1-1/2	660	740	800	330	Green		
	HD34	HU34	14	2-9/16	3	2-1/2	1-1/8	Min	4	16d			2	10d x 1-1/2	540			610	655
									4		4	465							
HD34IF	HUC34	14	2-9/16	3	2-1/2	--	Min	4	16d	2	10d x 1-1/2	540	610	655	265				
								4				4	465						

Copyright © 2019 MiTek Industries, Inc. All Rights Reserved

Hangers

1) Uplift loads have been increased 60% for wind or seismic loads; no further increase shall be permitted.  
 2) For JUS and HUS hangers: Nails must be driven at a 30° to 45° angle through the joist or truss into the header to achieve the table loads.  
 3) WS15 is 1/4" dia. x 1-1/2" long wood screw, WS3 is 1/4" x 3" long wood screw and are included with HDQ hangers.  
 4) **NAILS:** 10d x 1-1/2 nails are 0.148" dia. x 1-1/2" long, 10d nails are 0.148" dia. x 3" long, 16d nails are 0.162" dia. x 3-1/2" long.

**Corrosion Finish** ■ Stainless Steel ■ Gold Coat ■ HDG ■ Triple Zinc



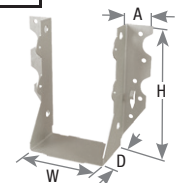
# Face Mount Hangers – SPF Allowable Loads

Hangers

Joist Size	MiTek USP Stock No.	Ref. No.	Steel Gauge	Dimensions (in)				Fastener Schedule <sup>3,4</sup>				SPF Allowable Loads (Lbs.) <sup>2</sup>				Corrosion Finish	Code Ref.		
				W	H	D	A	Min/Max	Header		Joist		Floor		Roof			Uplift <sup>1</sup>	
									Qty	Type	Qty	Type	100%	115%	125%				160%
3 x 6	JUS36	LUS36	18	2-9/16	5-1/4	2	1	--	4	16d	4	16d	915	1045	1135	1000			
	SUH36	U36	16	2-9/16	5-5/16	2	1-1/8	--	10	10d	4	10d x 1-1/2	1100	1235	1330	660			
										16d			1295	1465	1585				
	HD36	HU36	14	2-9/16	4-3/4	2-1/2	1-1/8	--	8	16d	<b>6</b>	10d x 1-1/2	1085	1220	1310	610			
HD36IF	HUC36	14	2-9/16	4-3/4	2-1/2	--	--	8	16d	<b>6</b>	10d x 1-1/2	1085	1220	1310	610				
3 x 8	JUS38	--	18	2-9/16	6-3/4	2	1	--	6	16d	4	16d	1165	1330	1445	1000			
	SUH36	U36	16	2-9/16	5-5/16	2	1-1/8	--	10	10d	4	10d x 1-1/2	1100	1235	1330	660			
										16d			1295	1465	1585				
	HD38	HU38	14	2-9/16	6-11/16	2-1/2	1-1/8	Min	10	16d	4	10d x 1-1/2	1355	1525	1640	605			
14									1895				2140	2295	945				
HD38IF	HUC38	14	2-9/16	6-11/16	2-1/2	--	Min	10	16d	4	10d x 1-1/2	1355	1525	1640	605				
								14				1895	2140	2295	945				
3 x 10	JUS310	LUS310	18	2-9/16	9-1/8	2	1	--	8	16d	6	16d	1625	1850	1915	1870			
	SUH310	U310	16	2-9/16	8-7/8	2	1-1/8	--	16	10d	6	10d x 1-1/2	1760	1975	2130	980			
										16d			2070	2175	2175				
	HD38	HU38	14	2-9/16	6-3/4	2	1-1/8	Min	10	16d	4	10d x 1-1/2	1355	1525	1640	605			
									14				1895	2140	2295	945			
	HD38IF	HUC38	14	2-9/16	6-3/4	2	--	Min	10	16d	4	10d x 1-1/2	1355	1525	1640	605			
									14				1895	2140	2295	945			
	HD310	HU310	14	2-9/16	7-7/16	2-1/2	1-1/8	Min	10	16d	4	10d x 1-1/2	1355	1525	1640	605			
14									1895				2140	2295	945				
HD310IF	HUC310	14	2-9/16	7-7/16	2-1/2	--	Min	10	16d	4	10d x 1-1/2	1355	1525	1640	605				
								14				1895	2140	2295	945				
HDQ310IF	HUCQ310	14	2-9/16	9	3	1-3/16	--	8	WS3	4	WS15	2985	3015	3015	930		IBC, FL, LA		
3 x 12	SUH310	U310	16	2-9/16	8-7/8	2	1-1/8	--	16	10d	6	10d x 1-1/2	1760	1975	2130	980			
										16d			2070	2175	2175				
	HD310	HU310	14	2-9/16	7-7/16	2-1/2	1-1/8	Min	10	16d	4	10d x 1-1/2	1355	1525	1640	605			
									14				1895	2140	2295	945			
	HD310IF	HUC310	14	2-9/16	7-7/16	2-1/2	--	Min	10	16d	4	10d x 1-1/2	1355	1525	1640	605			
									14				1895	2140	2295	945			
HDQ310IF	HUCQ310	14	2-9/16	9	3	1-3/16	--	8	WS3	4	WS15	2985	3015	3015	930				
HD312	HU312	14	2-9/16	9-5/16	2-1/2	1-1/8	Min	14	16d	6	10d x 1-1/2	1895	2140	2295	945				
								20				2710	2990	2990	1250				
HD312IF	HUC312	14	2-9/16	9-5/16	2-1/2	--	Min	14	16d	6	10d x 1-1/2	1895	2140	2295	945				
								20				2710	2990	2990	1250				
3 x 14	SUH314	U314	16	2-9/16	10-9/16	2	1-1/8	--	18	10d	6	10d x 1-1/2	1980	2220	2395	980			
										16d			2325	2640	2850				
	HDQ310IF	HUCQ310	14	2-9/16	9	3	1-3/16	--	8	WS3	4	WS15	2985	3015	3015	930			
	HD312	HU312	14	2-9/16	9-5/16	2-1/2	1-1/8	Min	14	16d	6	10d x 1-1/2	1895	2140	2295	945			
									20				2710	2990	2990	1250			
	HD312IF	HUC312	14	2-9/16	9-5/16	2-1/2	--	Min	14	16d	6	10d x 1-1/2	1895	2140	2295	945			
20									2710				2990	2990	1250				
HD314	HU314	14	2-9/16	11-5/16	2-1/2	1-1/8	Min	16	16d	8	10d x 1-1/2	2165	2445	2620	945				
								24				3250	3665	3770	1535				
HD314IF	HUC314	14	2-9/16	11-5/16	2-1/2	--	Min	16	16d	8	10d x 1-1/2	2165	2445	2620	945				
								24				3250	3665	3770	1535				

1) Uplift loads have been increased 60% for wind or seismic loads; no further increase shall be permitted.  
 2) For JUS and HUS hangers: Nails must be driven at a 30° to 45° angle through the joist or truss into the header to achieve the table loads.  
 3) WS15 is 1/4" dia. x 1-1/2" long wood screw, WS3 is 1/4" dia. x 3" long wood screw and are included with HDQ hangers.  
 4) **NAILS:** 10d x 1-1/2" nails are 0.148" dia. x 1-1/2" long, 10d nails are 0.148" dia. x 3" long, 16d nails are 0.162" dia. x 3-1/2" long.  
 New products or updated product information are designated in **blue font**.

**Corrosion Finish** ■ Stainless Steel ■ Gold Coat ■ HDG ■ Triple Zinc



Joist Size	MiTek USP Stock No.	Ref. No.	Steel Gauge	Dimensions (in)				Fastener Schedule <sup>3,4</sup>				SPF Allowable Loads (Lbs.) <sup>2</sup>				Corrosion Finish	Code Ref.		
				W	H	D	A	Min/Max	Header		Joist		Floor		Roof			Uplift <sup>1</sup>	
									Qty	Type	Qty	Type	100%	115%	125%				160%
				10d	16d	10d x 1-1/2	10d x 1-1/2	100%	115%	125%	160%								
3 x 16	SUH314	U314	16	2-9/16	10-9/16	2	1-1/8	--	18	10d	6	10d x 1-1/2	1980	2220	2395	980			
													2325	2640	2850				
	HD314	HU314	14	2-9/16	11-5/16	2-1/2	1-1/8	Min	16	16d	8	10d x 1-1/2	2165	2445	2620	945			
								Max	24		12		3250	3665	3770	1535			
	HD314IF	HUC314	14	2-9/16	11-5/16	2-1/2	--	Min	16	16d	8	10d x 1-1/2	2165	2445	2620	945			
							Max	24		12		3250	3665	3770	1535				
	HD316	HU316	14	2-9/16	13-5/16	2-1/2	1-1/8	Min	18	16d	8	10d x 1-1/2	2440	2750	2950	1245			
							Max	26		12		3520	3770	3770	1535				
	HD316IF	HUC316	14	2-9/16	13-5/16	2-1/2	--	Min	18	16d	8	10d x 1-1/2	2440	2750	2950	1245			
							Max	26		12		3520	3770	3770	1535				
(2) 3 x 8	HD38-2	HU38-2	14	5-1/8	6-1/8	2-1/2	1-1/8	Min	10	16d	4	10d	1355	1525	1640	685			
							Max	14		6		1895	2140	2295	1030				
(2) 3 x 10	HD38-2	HU38-2	14	5-1/8	6-1/8	2-1/2	1-1/8	Min	10	16d	4	10d	1355	1525	1640	685			
							Max	14		6		1895	2140	2295	1030				
	HD310-2	HU310-2	14	5-1/8	8	2-1/2	1-1/8	Min	14	16d	6	10d	1895	2140	2295	935			
							Max	20		10		2710	3055	3275	1235				
(2) 3 x 12	HD312-2	HU312-2	14	5-1/8	10	2-1/2	1-1/8	Min	16	16d	8	10d	2165	2445	2620	1035			
							Max	24		12		3250	3665	3930	2060				
(2) 3 x 14	HD312-2	HU312-2	14	5-1/8	10	2-1/2	1-1/8	Min	16	16d	8	10d	2165	2445	2620	1035			
							Max	24		12		3250	3665	3930	2060				
(3) 2 x 6	JUS26-3	LUS26-3	18	4-5/8	4-1/2	2	1	--	4	16d	4	16d	915	1045	1135	995			
	SUH26-3	U26-3	16	4-5/8	5-1/4	2	1	--	8	10d	2	10d	880	990	1065	330			
										16d			1035	1175	1265				
	HD26-3	HU26-3	14	4-5/8	4-1/2	2-1/2	1-1/8	Min	8	16d	4	10d	1085	1220	1310	600			
							Max	12		6		1625	1835	1965	1030				
	HD26-3IF	HUC26-3	14	4-5/8	4-1/2	2-1/2	--	Min	8	16d	4	10d	1085	1220	1310	600			
							Max	12		6		1625	1835	1965	1030				
(3) 2 x 8	JUS26-3	LUS26-3	18	4-5/8	4-1/2	2	1	--	4	16d	4	16d	915	1045	1135	995			
	JUS28-3	LUS28-3	18	4-5/8	6-3/8	2	1	--	6	16d	4	16d	1165	1330	1445	995			
	SUH26-3	U26-3	16	4-5/8	5-1/4	2	1	--	8	10d	2	10d	880	990	1065	330			
										16d			1035	1175	1265				
	HD26-3	HU26-3	14	4-5/8	4-1/2	2-1/2	1-1/8	Min	8	16d	4	10d	1085	1220	1310	600			
								Max	12		6		1625	1835	1965	1030			
	HD26-3IF	HUC26-3	14	4-5/8	4-1/2	2-1/2	--	Min	8	16d	4	10d	1085	1220	1310	600			
							Max	12		6		1625	1835	1965	1030				
	HD28-3	--	14	4-5/8	6-3/8	2-1/2	1-1/8	Min	10	16d	4	10d	1355	1525	1640	685			
							Max	14		6		1895	2140	2295	1030				
	HD28-3IF	--	14	4-5/8	6-3/8	2-1/2	--	Min	10	16d	4	10d	1355	1525	1640	685			
							Max	14		6		1895	2140	2295	1030				
(3) 2 x 10	JUS28-3	LUS28-3	18	4-5/8	6-3/8	2	1	--	6	16d	4	16d	1165	1330	1445	995			
	JUS210-3	LUS210-3	18	4-5/8	8-3/8	2	1	--	8	16d	6	16d	1625	1850	1900	1855			
	SUH210-3	U210-3	16	4-5/8	8-3/8	2	1	--	14	10d	6	10d	1540	1585	1585	970			
										16d			1585						
	HD28-3	--	14	4-5/8	6-3/8	2-1/2	1-1/8	Min	10	16d	4	10d	1355	1525	1640	685			
								Max	14		6		1895	2140	2295	1030			
	HD28-3IF	--	14	4-5/8	6-3/8	2-1/2	--	Min	10	16d	4	10d	1355	1525	1640	685			
								Max	14		6		1895	2140	2295	1030			
HD210-3	HU210-3	14	4-5/8	8-1/4	2-1/2	1-1/8	Min	14	16d	6	10d	1895	2140	2295	1030				
							Max	20		10		2710	3055	3275	1715				
HD210-3IF	HUC210-3	14	4-5/8	8-1/4	2-1/2	--	Min	14	16d	6	10d	1895	2140	2295	1030				
							Max	20		10		2710	3055	3275	1715				
HDQ210-3IF	HUCQ210-3	14	4-5/8	9	3	1-1/2	--	12	WS3	6	WS3	4670	4890	4890	2855				

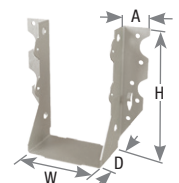
IBC,  
FL,  
LA

Hangers

Copyright © 2019 MiTek Industries, Inc. All Rights Reserved

1) Uplift loads have been increased 60% for wind or seismic loads; no further increase shall be permitted.  
 2) For JUS and HUS hangers: Nails must be driven at a 30° to 45° angle through the joist or truss into the header to achieve the table loads.  
 3) WS3 Wood Screws are 1/4" x 3" long and are included with HDQ hangers.  
 4) NAILS: 10d x 1-1/2 nails are 0.148" dia. x 1-1/2" long, 10d nails are 0.148" dia. x 3" long, 16d nails are 0.162" dia. x 3-1/2" long.

Corrosion Finish ■ Stainless Steel ■ Gold Coat ■ HDG ■ Triple Zinc

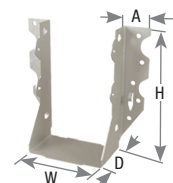


# Face Mount Hangers – SPF Allowable Loads

Joist Size	MiTek USP Stock No.	Ref. No.	Steel Gauge	Dimensions (in)				Fastener Schedule <sup>3,4</sup>				SPF Allowable Loads (Lbs.) <sup>2</sup>				Corrosion Finish	Code Ref.	
				W	H	D	A	Min/Max	Header		Joist		SPF Allowable Loads (Lbs.) <sup>2</sup>					
									Qty	Type	Qty	Type	Floor	Roof				Uplift <sup>1</sup>
100%	115%	125%	160%															
(3) 2 x 12	JUS210-3	LUS210-3	18	4-5/8	8-3/8	2	1	--	8	16d	6	16d	1625	1850	1900	1855	■	IBC, FL, LA
	SUH210-3	U210-3	16	4-5/8	8-3/8	2	1	--	14	10d 16d	6	10d	1540 1585	1585	1585	970	■	
	HD210-3	HU210-3	14	4-5/8	8-1/4	2-1/2	1-1/8	Min Max	14 20	16d	6 10	10d	1895 2710	2140 3055	2295 3275	1030 1715	■	
	HD210-3IF	HUC210-3	14	4-5/8	8-1/4	2-1/2	--	Min Max	14 20	16d	6 10	10d	1895 2710	2140 3055	2295 3275	1030 1715	■	
	HDQ210-3IF	HUCQ210-3	14	4-5/8	9	3	1-1/2	--	12	WS3	6	WS3	4670	4890	4890	2855	■	
	HD212-3	HU212-3	14	4-5/8	10-1/4	2-1/2	1-1/8	Min Max	16 24	16d	8 12	10d	2165 3250	2445 3625	2620 3625	1040 2060	■	
	HD212-3IF	HUC212-3	14	4-5/8	10-1/4	2-1/2	--	Min Max	16 24	16d	8 12	10d	2165 3250	2445 3625	2620 3625	1040 2060	■	
(3) 2 x 14	JUS210-3	LUS210-3	18	4-5/8	8-3/8	2	1	--	8	16d	6	16d	1625	1850	1900	1855	■	IBC, FL, LA
	SUH210-3	U210-3	16	4-5/8	8-3/8	2	1	--	14	10d 16d	6	10d	1540 1585	1585	1585	970	■	
	HDQ210-3IF	HUCQ210-3	14	4-5/8	9	3	1-1/2	--	12	WS3	6	WS3	4670	4890	4890	2855	■	
	HD212-3	HU212-3	14	4-5/8	10-1/4	2-1/2	1-1/8	Min Max	16 24	16d	8 12	10d	2165 3250	2445 3625	2620 3625	1040 2060	■	
	HD212-3IF	HUC212-3	14	4-5/8	10-1/4	2-1/2	--	Min Max	16 24	16d	8 12	10d	2165 3250	2445 3625	2620 3625	1040 2060	■	
	HD214-3	HU214-3	14	4-5/8	12-1/4	2-1/2	1-1/8	Min Max	18 26	16d	8 12	10d	2440 3520	2750 3970	2950 4025	1235 2060	■	
(3) 2 x 16	HD212-3	HU212-3	14	4-5/8	10-1/4	2-1/2	1-1/8	Min Max	16 24	16d	8 12	10d	2165 3250	2445 3625	2620 3625	1040 2060	■	IBC, FL, LA
	HD212-3IF	HUC212-3	14	4-5/8	10-1/4	2-1/2	--	Min Max	16 24	16d	8 12	10d	2165 3250	2445 3625	2620 3625	1040 2060	■	
	HD214-3	HU214-3	14	4-5/8	12-1/4	2-1/2	1-1/8	Min Max	18 26	16d	8 12	10d	2440 3520	2750 3970	2950 4025	1235 2060	■	
	HD216-3	HU216-3	14	4-5/8	13-1/4	2-1/2	1-1/8	Min Max	22 30	16d	10 14	10d	2980 4035	3360 4035	3605 4035	1715 2405	■	
(4) 2 x 8	HD28-4	HU28-4	14	6-1/8	7	2-1/2	1-3/4	Min Max	10 14	16d	4 6	16d	1355 1895	1525 2140	1640 2295	685 1035	■	IBC, FL, LA
(4) 2 x 10	HD210-4	HU210-4	14	6-1/8	9-1/4	2-1/2	2	Min Max	14 18	16d	6 8	16d	1895 2440	2140 2750	2295 2945	1035 1585	■	
(4) 2 x 12	HD210-4	HU210-4	14	6-1/8	9-1/4	2-1/2	2	Min Max	14 18	16d	6 8	16d	1895 2440	2140 2750	2295 2945	1035 1585	■	
(4) 2 x 14	HD210-4	HU210-4	14	6-1/8	9-1/4	2-1/2	2	Min Max	14 18	16d	6 8	16d	1895 2440	2140 2750	2295 2945	1035 1585	■	
4 x 4	JUS44	LUS44	18	3-5/8	3-1/4	2	1	--	4	16d	2	16d	615	615	615	495	■	
	SUH44	U44	16	3-9/16	2-7/8	2	1-1/8	--	6	10d 16d	2	10d	660 775	740 880	800 950	330	■	
	HD44	HU44	14	3-9/16	3-5/16	2-1/2	1-1/8	--	4	16d	2	10d	540	610	655	345	■	
	HD44IF	HUC44	14	3-9/16	3-5/16	2-1/2	--	--	4	16d	2	10d	540	610	655	345	■	

1) Uplift loads have been increased 60% for wind or seismic loads; no further increase shall be permitted.  
 2) For JUS and HUS hangers: Nails must be driven at a 30° to 45° angle through the joist or truss into the header to achieve the table loads.  
 3) WS3 Wood Screws are 1/4" x 3" long and are included with HDQ hangers.  
 4) **NAILS:** 10d nails are 0.148" dia. x 3" long, 16d nails are 0.162" dia. x 3-1/2" long.

**Corrosion Finish** ■ Stainless Steel ■ Gold Coat ■ HDG ■ Triple Zinc

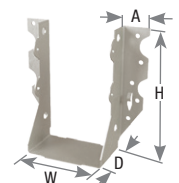




Joist Size	MiTek USP Stock No.	Ref. No.	Steel Gauge	Dimensions (in)				Fastener Schedule <sup>3,4</sup>				SPF Allowable Loads (Lbs.) <sup>2</sup>				Corrosion Finish	Code Ref.		
				W	H	D	A	Min/Max	Header		Joist		Floor		Roof			Uplift <sup>1</sup>	
									Qty	Type	Qty	Type	100%	115%	125%				160%
4 x 6	JUS46	LUS46	18	3-5/8	5	2	1	--	4	16d	4	16d	915	1045	1135	995			
	SUH46	U46	16	3-9/16	4-13/16	2	1-1/8	--	10	10d 16d	4	10d	1100 1295	1235 1465	1330 1580	660			
	HUS46	HUS46	14	3-5/8	5	2	1	--	4	16d	4	16d	955	1085	1170	850			
	HUS46IF	HUSC46	14	3-5/8	5	2	1	--	4	16d	4	16d	955	1085	1170	850			
	HD46	HU46	14	3-9/16	5-1/16	2-1/2	1-1/8	Min Max	8 12	16d	4 6	10d	1085 1625	1220 1835	1310 1965	605 1030			
	HD46IF	HUC46	14	3-9/16	5-1/16	2-1/2	--	Min Max	8 12	16d	4 6	10d	1085 1625	1220 1835	1310 1965	605 1030			
4 x 8	JUS46	LUS46	18	3-5/8	5	2	1	--	4	16d	4	16d	915	1045	1135	995			
	JUS48	LUS48	18	3-5/8	6-7/8	2	1	--	6	16d	4	16d	1165	1330	1445	995			
	SUH46	U46	16	3-9/16	4-13/16	2	1-1/8	--	10	10d 16d	4	10d	1100 1295	1235 1465	1330 1580	660			
	HUS46	HUS46	14	3-5/8	5	2	1	--	4	16d	4	16d	955	1085	1170	850			
	HUS46IF	HUSC46	14	3-5/8	5	2	1	--	4	16d	4	16d	955	1085	1170	850			
	HUS48	HUS48	14	3-5/8	7	2	1	--	6	16d	6	16d	1430	1490	1490	1905			
	HUS48IF	HUSC48	14	3-5/8	7	2	1	--	6	16d	6	16d	1430	1490	1490	1905			
	HD46	HU46	14	3-9/16	5-1/16	2-1/2	1-1/8	Min Max	8 12	16d	4 6	10d	1085 1625	1220 1835	1310 1965	605 1030			
	HD46IF	HUC46	14	3-9/16	5-1/16	2-1/2	--	Min Max	8 12	16d	4 6	10d	1085 1625	1220 1835	1310 1965	605 1030			
	HD48	HU48	14	3-9/16	6-15/16	2-1/2	1-1/8	Min Max	10 14	16d	4 6	10d	1355 1895	1525 2140	1640 2295	685 1030		IBC, FL, LA	
HD48IF	HUC48	14	3-9/16	6-15/16	2-1/2	--	Min Max	10 14	16d	4 6	10d	1355 1895	1525 2140	1640 2295	685 1030				
4 x 10	JUS48	LUS48	18	3-5/8	6-7/8	2	1	--	6	16d	4	16d	1165	1330	1445	995			
	JUS410	LUS410	18	3-5/8	8-7/8	2	1	--	8	16d	6	16d	1625	1850	1905	1860			
	SUH410	U410	16	3-9/16	8-3/8	2	1-1/8	--	16	10d 16d	6	10d	1760 2070	1975 2345	2130 2535	975			
	HUS48	HUS48	14	3-5/8	7	2	1	--	6	16d	6	16d	1430	1490	1490	1905			
	HUS48IF	HUSC48	14	3-5/8	7	2	1	--	6	16d	6	16d	1430	1490	1490	1905			
	HD48	HU48	14	3-9/16	6-15/16	2-1/2	1-1/8	Min Max	10 14	16d	4 6	10d	1355 1895	1525 2140	1640 2295	685 1030			
	HD48IF	HUC48	14	3-9/16	6-15/16	2-1/2	--	Min Max	10 14	16d	4 6	10d	1355 1895	1525 2140	1640 2295	685 1030			
	HUS410	HUS410	14	3-5/8	8-7/8	2	1	--	8	16d	8	16d	1905	2170	2315	1915			
	HUS410IF	HUSC410	14	3-5/8	8-7/8	2	1	--	8	16d	8	16d	1905	2170	2315	1915			
	HD410	HU410	14	3-9/16	8-13/16	2-1/2	1-1/8	Min Max	14 20	16d	6 10	10d	1895 2710	2140 2970	2295 2970	1030 1715			
HD410IF	HUC410	14	3-9/16	8-13/16	2-1/2	--	Min Max	14 20	16d	6 10	10d	1895 2710	2140 2970	2295 2970	1030 1715				
HDQ410IF	HUCQ410	14	3-9/16	9	3	1-1/2	--	12	WS3	6	WS3	4670	4900	4900	2865				

- 1) Uplift loads have been increased 60% for wind or seismic loads; no further increase shall be permitted.
- 2) For JUS and HUS hangers: Nails must be driven at a 30° to 45° angle through the joist or truss into the header to achieve the table loads.
- 3) WS3 Wood Screws are 1/4" x 3" long and are included with HDQ hangers.
- 4) NAILS: 10d nails are 0.148" dia. x 3" long, 16d nails are 0.162" dia. x 3-1/2" long.

Corrosion Finish ■ Stainless Steel ■ Gold Coat ■ HDG ■ Triple Zinc



# Face Mount Hangers – SPF Allowable Loads

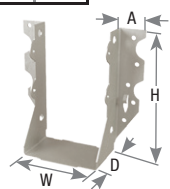
Joist Size	MiTek USP Stock No.	Ref. No.	Steel Gauge	Dimensions (in)				Fastener Schedule <sup>3,4</sup>				SPF Allowable Loads (Lbs.) <sup>2</sup>				Corrosion Finish	Code Ref.	
				W	H	D	A	Min/Max	Header		Joist		Allowable Loads (Lbs.) <sup>2</sup>					
									Qty	Type	Qty	Type	Floor	Roof	Uplift <sup>1</sup>			
100%	115%	125%	160%															
4 x 12	JUS410	LUS410	18	3-5/8	8-7/8	2	1	--	8	16d	6	16d	1625	1850	1905	1860		
	SUH410	U410	16	3-9/16	8-3/8	2	1-1/8	--	16	10d	6	10d	1760	1975	2130	975		
	HUS410	HUS410	14	3-5/8	8-7/8	2	1	--	8	16d	8	16d	1905	2170	2315	1915		
	HUS410IF	HUSC410	14	3-5/8	8-7/8	2	1	--	8	16d	8	16d	1905	2170	2315	1915		
	HD410	HU410	14	3-9/16	8-13/16	2-1/2	1-1/8	Min	14	16d	6	10d	1895	2140	2295	1030		
								Max	20		10		2710	2970	2970	1715		
	HD410IF	HUC410	14	3-9/16	8-13/16	2-1/2	--	Min	14	16d	6	10d	1895	2140	2295	1030		
								Max	20		10		2710	2970	2970	1715		
	HDQ410IF	HUCQ410	14	3-9/16	9	3	1-1/2	--	12	WS3	6	WS3	4670	4900	4900	2865		
	HUS412	HUS412	14	3-5/8	10-7/8	2	1	--	10	16d	10	16d	2385	2710	2830	3080		
	HUS412IF	HUSC412	14	3-5/8	10-7/8	2	1	--	10	16d	10	16d	2385	2710	2830	3080		
4 x 14	JUS414	LUS414	18	3-5/8	12-7/8	2	1	--	12	16d	6	16d	1905	1905	1905	1860		
	SUH414	U414	16	3-9/16	10-1/16	2	1-1/8	--	18	10d	6	10d	1980	2220	2395	975		
										16d			2325	2640	2850			
	HD410	HU410	14	3-9/16	8-13/16	2-1/2	1-1/8	Min	14	16d	6	10d	1895	2140	2295	1030		
								Max	20		10		2710	2970	2970	1715		
	HD410IF	HUC410	14	3-9/16	8-13/16	2-1/2	--	Min	14	16d	6	10d	1895	2140	2295	1030		
								Max	20		10		2710	2970	2970	1715		
	HDQ410IF	HUCQ410	14	3-9/16	9	3	1-1/2	--	12	WS3	6	WS3	4670	4900	4900	2865		
	HUS412	HUS412	14	3-5/8	10-7/8	2	1	--	10	16d	10	16d	2385	2710	2830	3080		
	HUS412IF	HUSC412	14	3-5/8	10-7/8	2	1	--	10	16d	10	16d	2385	2710	2830	3080		
	HDQ412IF	HUCQ412	14	3-9/16	11	3	1-1/2	--	14	WS3	6	WS3	4980	4980	4980	2775		
4 x 16	JUS414	LUS414	18	3-5/8	12-7/8	2	1	--	12	16d	6	16d	1905	1905	1905	1860		
	SUH414	U414	16	3-9/16	10-1/16	2	1-1/8	--	18	10d	6	10d	1980	2220	2395	975		
										16d			2325	2640	2850			
	HD412	HU412	14	3-9/16	10-13/16	2-1/2	1-1/8	Min	16	16d	8	10d	2165	2445	2620	1040		
								Max	24		12		3250	3665	3860	2060		
	HD412IF	HUC412	14	3-9/16	10-13/16	2-1/2	--	Min	16	16d	8	10d	2165	2445	2620	1040		
								Max	24		12		3250	3665	3860	2060		
	HDQ412IF	HUCQ412	14	3-9/16	11	3	1-1/2	--	14	WS3	6	WS3	4980	4980	4980	2775		
	HD414	HU414	14	3-9/16	12-13/16	2-1/2	1-1/8	Min	18	16d	8	10d	2440	2750	2950	1235		
								Max	26		12		3520	3860	3860	2060		
	HD414IF	HUC414	14	3-9/16	12-13/16	2-1/2	--	Min	18	16d	8	10d	2440	2750	2950	1235		
							Max	26		12		3520	3860	3860	2060			
4 x 16	HD416	HU416	14	3-9/16	14-13/16	2-1/2	1-1/8	Min	22	16d	10	10d	2980	3360	3605	1715		
							Max	30		14		3990	3990	3990	1805			
	HD416IF	HUC416	14	3-9/16	14-13/16	2-1/2	--	Min	22	16d	10	10d	2980	3360	3605	1715		
							Max	30		14		3990	3990	3990	1805			

IBC, FL, LA

Copyright © 2019 MiTek Industries, Inc. All Rights Reserved

1) Uplift loads have been increased 60% for wind or seismic loads; no further increase shall be permitted.  
 2) For JUS and HUS hangers: Nails must be driven at a 30° to 45° angle through the joist or truss into the header to achieve the table loads.  
 3) WS3 Wood Screws are 1/4" dia. x 3" long and are included with HDQ hangers.  
 4) **NAILS:** 10d nails are 0.148" dia. x 3" long, 16d nails are 0.162" dia. x 3-1/2" long.

**Corrosion Finish** ■ Stainless Steel ■ Gold Coat ■ HDG ■ Triple Zinc



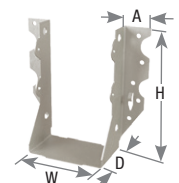
Joist Size	MiTek USP Stock No.	Ref. No.	Steel Gauge	Dimensions (in)				Fastener Schedule <sup>3</sup>				SPF Allowable Loads (Lbs.) <sup>2</sup>				Corrosion Finish	Code Ref.	
								Header		Joist		Floor		Roof				Uplift <sup>1</sup>
				Min/Max	Qty	Type	Qty	Type	100%	115%	125%	160%						
4 x 18	HD414	HU414	14	3-9/16	12-13/16	2-1/2	1-1/8	Min 18 Max 26	18	16d	8	10d	2440 3520	2750 3860	2950 3860	1235 2060		
	HD414IF	HUC414	14	3-9/16	12-13/16	2-1/2	--	Min 18 Max 26	18	16d	8	10d	2440 3520	2750 3860	2950 3860	1235 2060		
	HD416	HU416	14	3-9/16	14-13/16	2-1/2	1-1/8	Min 22 Max 30	22	16d	10	10d	2980 3990	3360 3990	3605 3990	1715 1805		
	HD416IF	HUC416	14	3-9/16	14-13/16	2-1/2	--	Min 22 Max 30	22	16d	10	10d	2980 3990	3360 3990	3605 3990	1715 1805		
	HD418	--	14	3-9/16	16-1/2	2-1/2	1-1/4	--	28	16d	8	10d	3795	3835	3835	1375		
6 x 6	SUH66	U66	16	5-1/2	5	2	1	--	8	10d 16d	4	10d	880 1035	990 1175	1065 1265	655		
	HD66	HU66	14	5-1/2	4-1/16	2-1/2	1-1/8	Min 8 Max 12	8	16d	4	16d	1085 1625	1220 1835	1310 1965	685 1035		
	HD66IF	HUC66	14	5-1/2	4-1/16	2-1/2	--	Min 8 Max 12	8	16d	4	16d	1085 1625	1220 1835	1310 1965	685 1035		
6 x 8	SUH66	U66	16	5-1/2	5	2	1	--	8	10d 16d	4	10d	880 1035	990 1175	1065 1265	655		
	HD66	HU66	14	5-1/2	4-1/16	2-1/2	1-1/8	Min 8 Max 12	8	16d	4	16d	1085 1625	1220 1835	1310 1965	685 1035		
	HD66IF	HUC66	14	5-1/2	4-1/16	2-1/2	--	Min 8 Max 12	8	16d	4	16d	1085 1625	1220 1835	1310 1965	685 1035		
	HD68	HU68	14	5-1/2	5-15/16	2-1/2	1-1/8	Min 10 Max 14	10	16d	4	16d	1355 1895	1525 2140	1640 2295	760 1035		IBC, FL, LA
	HD68IF	HUC68	14	5-1/2	5-15/16	2-1/2	--	Min 10 Max 14	10	16d	4	16d	1355 1895	1525 2140	1640 2295	760 1035		IBC, FL, LA
6 x 10	SUH610	U610	16	5-1/2	9	2	1	--	14	10d 16d	6	10d	1540 1810	1730 2055	1865 2215	970		
	HD68	HU68	14	5-1/2	5-15/16	2-1/2	1-1/8	Min 10 Max 14	10	16d	4	16d	1355 1895	1525 2140	1640 2295	760 1035		
	HD68IF	HUC68	14	5-1/2	5-15/16	2-1/2	--	Min 10 Max 14	10	16d	4	16d	1355 1895	1525 2140	1640 2295	760 1035		
	HD610	HU610	14	5-1/2	7-13/16	2-1/2	1-1/8	Min 14 Max 20	14	16d	6	16d	1895 2710	2140 3055	2295 3275	1035 2025		
	HD610IF	HUC610	14	5-1/2	7-13/16	2-1/2	--	Min 14 Max 20	14	16d	6	16d	1895 2710	2140 3055	2295 3275	1035 2025		
	HDQ610IF	HUCQ610	14	5-1/2	9	3	1-1/8	--	12	WS3	6	WS3	4670	4885	4885	2855		
6 x 12	SUH610	U610	16	5-1/2	9	2	1	--	14	10d 16d	6	10d	1540 1810	1730 2055	1865 2215	970		
	HD610	HU610	14	5-1/2	7-13/16	2-1/2	1-1/8	Min 14 Max 20	14	16d	6	16d	1895 2710	2140 3055	2295 3275	1035 2025		
	HD610IF	HUC610	14	5-1/2	7-13/16	2-1/2	--	Min 14 Max 20	14	16d	6	16d	1895 2710	2140 3055	2295 3275	1035 2025		
	HDQ610IF	HUCQ610	14	5-1/2	9	3	1-1/2	--	12	WS3	6	WS3	4670	4885	4885	2855		
	HD612	HU612	14	5-1/2	9-13/16	2-1/2	1-1/8	Min 16 Max 24	16	16d	8	16d	2165 3250	2445 3665	2620 3930	1035 2430		
	HD612IF	HUC612	14	5-1/2	9-13/16	2-1/2	--	Min 16 Max 24	16	16d	8	16d	2165 3250	2445 3665	2620 3930	1035 2430		
	HDQ612IF	HUCQ612	14	5-1/2	11	3	1-1/2	--	14	WS3	6	WS3	4960	4960	4960	2770		

Copyright © 2019 MiTek Industries, Inc. All Rights Reserved

Hangers

1) Uplift loads have been increased 60% for wind or seismic loads; no further increase shall be permitted.  
 2) WS3 Wood Screws are 1/4" dia. x 3" long and are included with HDQ hangers.  
 3) **NAILS:** 10d nails are 0.148" dia. x 3" long, 16d nails are 0.162" dia. x 3-1/2" long.

**Corrosion Finish** ■ Stainless Steel ■ Gold Coat ■ HDG ■ Triple Zinc

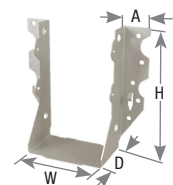


# Face Mount Hangers – SPF Allowable Loads

Joist Size	MiTek USP Stock No.	Ref. No.	Steel Gauge	Dimensions (in)				Fastener Schedule <sup>3</sup>				SPF Allowable Loads (Lbs.) <sup>2</sup>				Corrosion Finish	Code Ref.	
				W	H	D	A	Min/Max	Header		Joist		Floor 100%	Roof				Uplift <sup>1</sup> 160%
									Qty	Type	Qty	Type		115%	125%			
6 x 14	HDQ610IF	HUCQ610	14	5-1/2	9	3	1-1/2	--	12	WS3	6	WS3	4670	4885	4885	2855	IBC, FL, LA	
	HD612	HU612	14	5-1/2	9-13/16	2-1/2	1-1/8	Min	16	16d	8	16d	2165	2445	2620	1035		
								Max	24		12		3250	3665	3930	2430		
	HD612IF	HUC612	14	5-1/2	9-13/16	2-1/2	--	Min	16	16d	8	16d	2165	2445	2620	1035		
								Max	24		12		3250	3665	3930	2430		
	HDQ612IF	HUCQ612	14	5-1/2	11	3	1-1/2	--	14	WS3	6	WS3	4960	4960	4960	2770		
HD614	HU614	14	5-1/2	11-13/16	2-1/2	1-1/8	Min	18	16d	8	16d	2440	2750	2950	1585			
							Max	26		12		3520	3970	4020	2430			
HD614IF	HUC614	14	5-1/2	11-13/16	2-1/2	--	Min	18	16d	8	16d	2440	2750	2950	1585			
							Max	26		12		3520	3970	4020	2430			
6 x 16	HD612	HU612	14	5-1/2	9-13/16	2-1/2	1-1/8	Min	16	16d	8	16d	2165	2445	2620	1035		
								Max	24		12		3250	3665	3930	2430		
	HD612IF	HUC612	14	5-1/2	9-13/16	2-1/2	--	Min	16	16d	8	16d	2165	2445	2620	1035		
								Max	24		12		3250	3665	3930	2430		
	HDQ612IF	HUCQ612	14	5-1/2	11	3	1-1/2	--	14	WS3	6	WS3	4960	4960	4960	2770		
	HD614	HU614	14	5-1/2	11-13/16	2-1/2	1-1/8	Min	18	16d	8	16d	2440	2750	2950	1585		
Max								26	12		3520		3970	4020	2430			
HD614IF	HUC614	14	5-1/2	11-13/16	2-1/2	--	Min	18	16d	8	16d	2440	2750	2950	1585			
							Max	26		12		3520	3970	4020	2430			
HD616	HU616	14	5-1/2	13-13/16	2-1/2	1-1/8	Min	22	16d	10	16d	2980	3360	3605	2025			
							Max	30		14		3970	3970	3970	2835			
HD616IF	HUC616	14	5-1/2	13-13/16	2-1/2	--	Min	22	16d	10	16d	2980	3360	3605	2025			
							Max	30		14		3970	3970	3970	2835			
6 x 18	HD614	HU614	14	5-1/2	11-13/16	2-1/2	1-1/8	Min	18	16d	8	16d	2440	2750	2950	1585		
								Max	26		12		3520	3970	4020	2430		
	HD614IF	HUC614	14	5-1/2	11-13/16	2-1/2	--	Min	18	16d	8	16d	2440	2750	2950	1585		
								Max	26		12		3520	3970	4020	2430		
HD616	HU616	14	5-1/2	13-13/16	2-1/2	1-1/8	Min	22	16d	10	16d	2980	3360	3605	2025			
							Max	30		14		3970	3970	3970	2835			
HD616IF	HUC616	14	5-1/2	13-13/16	2-1/2	--	Min	22	16d	10	16d	2980	3360	3605	2025			
							Max	30		14		3970	3970	3970	2835			
8 x 6	HD86	--	14	7-1/2	4-15/16	2-1/2	1-1/2	Min	8	16d	4	16d	1085	1220	1310	680		
								Max	10		4		1355	1525	1640	760		
8 x 8	HD88	HU88	14	7-1/2	6-13/16	2-1/2	1-1/2	Min	10	16d	4	16d	1355	1525	1640	760		
								Max	14		6		1895	2140	2295	1030		
8 x 8	HD88IF	HUC88	14	7-1/2	6-13/16	2-1/2	--	Min	10	16d	4	16d	1355	1525	1640	760		
								Max	14		6		1895	2140	2295	1030		

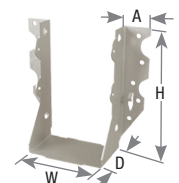
1) Uplift loads have been increased 60% for wind or seismic loads; no further increase shall be permitted.  
 2) WS3 Wood Screws are 1/4" dia. x 3" long and are included with HDQ hangers.  
 3) **NAILS:** 10d x 1-1/2 nails are 0.148" dia. x 1-1/2" long, 10d nails are 0.148" dia. x 3" long, 16d nails are 0.162" dia. x 3-1/2" long.

**Corrosion Finish** ■ Stainless Steel ■ Gold Coat ■ HDG ■ Triple Zinc



Joist Size	MiTek USP Stock No.	Ref. No.	Steel Gauge	Dimensions (in)				Fastener Schedule <sup>2</sup>				SPF Allowable Loads (Lbs.)				Code Ref.	
				W	H	D	A	Min/Max	Header		Joist		SPF Allowable Loads (Lbs.)				
									Qty	Type	Qty	Type	Floor	Roof	Uplift <sup>1</sup>		
100%	115%	125%	160%														
8 x 10	HD810	HU810	14	7-1/2	8-9/16	2-1/2	1-1/2	Min	14	16d	6	16d	1895	2140	2295	1030	
								Max	18		8		2440	2750	2940	1585	
	HD810IF	HUC810	14	7-1/2	8-9/16	2-1/2	--	Min	14	16d	6	16d	1895	2140	2295	1030	
								Max	18		8		2440	2750	2940	1585	
8 x 12	HD812	HU812	14	7-1/2	10-1/2	2-1/2	1-1/2	Min	16	16d	6	16d	2165	2445	2620	1030	
								Max	22		8		2980	3360	3605	1620	
	HD812IF	HUC812	14	7-1/2	10-1/2	2-1/2	--	Min	16	16d	6	16d	2165	2445	2620	1030	
								Max	22		8		2980	3360	3605	1620	
8 x 14	HD814	HU814	14	7-1/2	11-13/16	2-1/2	1-1/2	Min	18	16d	8	16d	2440	2750	2940	1585	
								Max	24		12		3250	3665	3710	2430	
	HD814IF	HUC814	14	7-1/2	11-13/16	2-1/2	--	Min	18	16d	8	16d	2440	2750	2940	1585	
								Max	24		12		3250	3665	3710	2430	
8 x 16	HD816	HU816	14	7-1/2	12-13/16	2-1/2	1-1/2	Min	20	16d	8	16d	2710	2940	2940	1585	
								Max	26		12		3520	3710	3710	2430	
	HD816IF	HUC816	14	7-1/2	13-5/8	2-1/2	--	Min	26	16d	12	16d	3520	3710	3710	2430	
								Max	26		12		3520	3710	3710	2430	
<b>ROUGH LUMBER SIZES</b>																	
2 x 4	SUH24R	LU24R-18, U24R	16	2	3-1/16	2	1-1/8	--	4	10d	2	10d x 1-1/2	440	495	530	310	
										16d			515	585	635		
2 x 6 - 8	SUH26R	LU26R-18, U26R	16	2	4-15/16	2	1-3/16	--	6	10d	4	10d x 1-1/2	660	740	800	660	
										16d			775	880	950		
2 x 8 - 10	SUH28R	LU28R-18	16	2	6-7/16	2	1-1/8	--	8	10d	6	10d x 1-1/2	880	990	1055	665	
										16d			1035	1175	1265		
2 x 10 - 12	SUH210R	LU210R-18, U210R	16	2	7-13/16	2	1-1/8	--	10	10d	6	10d x 1-1/2	1100	1235	1330	980	
										16d			1295	1465	1585		
2 x 14 - 16	SUH214R	--	16	2	9-13/16	2	1-1/8	--	12	10d	8	10d x 1-1/2	1320	1480	1595	1330	
										16d			1550	1760	1900		
4 x 4	SUH44R	U44R	16	4	2-11/16	2	1-1/8	--	6	10d	2	16d	660	740	800	350	
										16d			775	880	950		
4 x 6	SUH46R	U46R	16	4	4-11/16	2	1-1/8	--	8	10d	4	16d	880	990	1065	660	
										16d			1035	1175	1265		
4 x 10 - 12	SUH410R	U410R	16	4	8-3/16	2	2	--	14	10d	6	16d	1540	1730	1865	975	
										16d			1810	2055	2215		
6 x 8	SUH66R	U66R	16	6	5	2	1	--	8	10d	4	16d	880	990	1065	655	
										16d			1035	1175	1265		
6 x 10 - 12 - 14	SUH610R	U610R	16	6	9	2	1	--	14	10d	6	16d	1540	1730	1865	970	
										16d			1810	2055	2215		
<b>GLULAM SIZES</b>																	
3-1/8 x 10-1/2 - 19-1/2	HD32105	HU3.25/10.5	14	3-1/4	9-15/16	2-1/2	1-1/8	Min	16	16d	6	10d	2165	2445	2620	940	
								Max	22		10		2980	3360	3605	1715	
3-1/8 x 12 - 21	HD3212	HU3.25/12	14	3-1/4	11-7/8	2-1/2	1-1/8	Min	18	16d	8	10d	2440	2750	2950	1240	
								Max	26		12		3520	3970	4045	2060	
5-1/8 x 10-1/2 - 19-1/2	HD5112	HU5.125/12	14	5-1/4	9-15/16	2-1/2	1-1/8	Min	16	16d	8	16d	2165	2445	2620	1040	
								Max	24		12		3250	3625	3625	2430	
5-1/8 x 14-1/2 - 21	HD51135	HU5.125/13.5	14	5-1/4	12-15/16	2-1/2	1-1/8	Min	20	16d	10	16d	2710	2960	2960	2025	
								Max	28		14		3795	4030	4030	2835	

1) Uplift loads have been increased 60% for wind or seismic loads; no further increase shall be permitted.  
 2) **NAILS:** 10d x 1-1/2 nails are 0.148" dia. x 1-1/2" long, 10d nails are 0.148" dia. x 3" long, 16d nails are 0.162" dia. x 3-1/2" long.



# FWHFM Fire Wall Hangers for Face Mount Applications



The FWHFM hanger fastens to the wide face of a balloon framed SCL column thereby eliminating the additive perpendicular-to-grain bearing stresses in the wall top and bottom plates seen with platform framing. As with the FWH hanger, the advanced design allows you to install the hangers before the gypsum wallboard (drywall) is attached, allowing your project to be completely framed-up and weather-tight before the gypsum wallboard sheathing shows up on site.

**Features and Benefits:**

- Face mount hanger design installs with nails
- Attaches to the wide face of columns
- Hanger web accommodates 2-ply of 5/8" gypsum wallboard
- Achieve full table loads with or without drywall installation

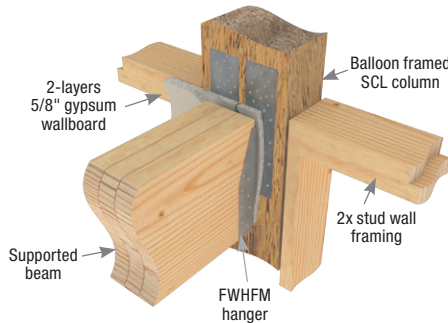
**Materials:** 12 gauge

**Finish:** Primer

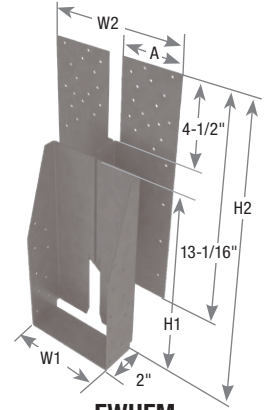
**Patents:** Pending

**Installation:**

- Install the face of hanger flanges tight to SCL column/framing.
- The end of the truss/joist should measure 1-5/8" from the face of the supporting column.
- The truss/joist should bear fully on the FWH seat with a gap no greater than 1/8" between the end of the supported member and the hanger.
- Gypsum Wallboard Installation – Use the FWH-T template to slot cut the gypsum wallboard. See FWH-T Template Sequence. Slide the gypsum wallboard into position and fasten to the framing members meeting the minimum requirements specified by code.



Typical FWHFM installation



FWHFM



**FWH-T template**  
(must be ordered separately)

Joist Size (in)	MiTek USP Stock No.	Ref. No.	Steel Gauge	Dimensions (in)						Fastener Schedule <sup>3</sup>				DF/SP Allowable Loads (Lbs.)				Code Ref.
				W1	W2	H1	H2	D	A	Header		Joist		Download <sup>1</sup>			Uplift 160% <sup>2</sup>	
										Face Qty	Type	Qty	Type	100%	115%	125%		
3-1/2 x 9-1/4	FWHFM35925	--	12	3-9/16	4-11/16	9-1/16	13-9/16	2	2-1/16	40	10d	18	10d x 1-1/2	5960	6625	7050	2990	
3-1/2 x 9-1/2	FWHFM3595					9-5/16	13-13/16											
3-1/2 x 11-7/8	FWHFM35118					11-11/16	16-3/16											
3-1/2 x 14	FWHFM3514					13-13/16	18-5/16											
3-1/2 x 16	FWHFM3516					15-13/16	20-5/16											
3-1/2 x 18	FWHFM3518					17-13/16	22-5/16											
3-1/2 x 20	FWHFM3520					19-13/16	24-5/16											
3-1/2 x 22	FWHFM3522					21-13/16	26-5/16											
3-1/2 x 24	FWHFM3524					23-13/16	28-5/16											
4 - 4-3/16 x 9-1/4	FWHFM42925					--	12											
4 - 4-3/16 x 9-1/2	FWHFM4295	9-5/16	13-13/16															
4 - 4-3/16 x 11-7/8	FWHFM42118	11-7/16	15-15/16															
4 - 4-3/16 x 14	FWHFM4214	13-5/8	18-1/8															
4 - 4-3/16 x 16	FWHFM4216	15-5/8	20-1/8															
4 - 4-3/16 x 18	FWHFM4218	17-5/8	22-1/8															
4 - 4-3/16 x 20	FWHFM4220	19-5/8	24-1/8															
4 - 4-3/16 x 22	FWHFM4222	21-5/8	26-1/8															
4 - 4-3/16 x 24	FWHFM4224	23-5/8	28-1/8															
5-1/4 x 9-1/4	FWHFM52925	--	12	5-3/8	6-1/2			9-1/16	13-9/16	2	3	40	10d	18	10d x 1-1/2	5960	6625	7050
5-1/4 x 9-1/2	FWHFM5295					9-5/16	13-13/16											
5-1/4 x 11-7/8	FWHFM52118					11-5/8	16-1/8											
5-1/4 x 14	FWHFM5214					13-13/16	18-5/16											
5-1/4 x 16	FWHFM5216					15-13/16	20-5/16											
5-1/4 x 18	FWHFM5218					17-13/16	22-5/16											
5-1/4 x 20	FWHFM5220					19-23/28	24-5/16											
5-1/4 x 22	FWHFM5222					21-13/16	26-5/16											
5-1/4 x 24	FWHFM5224					23-13/16	28-5/16											
7 x 11-7/8	FWHFM71118					--	12	7-1/8	8-1/4									
7 x 14	FWHFM7114	13-13/16	18-5/16															
7 x 16	FWHFM7116	15-13/16	20-5/16															
7 x 18	FWHFM7118	17-13/16	22-5/16															
7 x 20	FWHFM7120	19-13/16	24-5/16															
7 x 22	FWHFM7122	21-13/16	26-5/16															
7 x 24	FWHFM7124	23-13/16	28-5/16															

1) Download allowable load is for attachment to the wide face of a supporting column.  
 2) Uplift loads have been increased 60% for wind or seismic loads. No further increase shall be permitted  
 3) Distance from the supported member to the edge of header support flange is 9/16"

4) **NAILS:** 10d x 1-1/2" nails are 0.148" dia. x 1-1/2" long, 10d nails are 0.148 dia. x 3" long. New products or updated product information are designated in **blue font**.

# ADTT-TZ Adjustable Deck Tension Tie

Deck collapses are often caused by failure of the connection where the deck is attached to the main structure due to little or no lateral capacity. ADTT-TZ is an Adjustable Deck Tension Tie designed to effectively transfer the out of plane lateral loads of the deck to the house structure.

**Features:**

- Adjustable design allows lag screw installation at variable distance below deck joist.
- 2-hole break-out washer (BO-W) will work with multiple screw sizes.
- Blocking extensions not required.

**Materials:** 14 gauge

**Finish:** G-185 galvanizing

**Codes:** See page 12 for Code Reference Chart

**Patents:** U.S. Patent No. 9,809,974

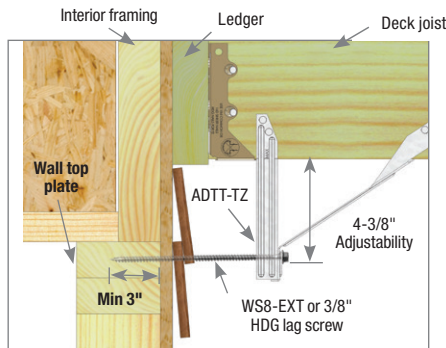
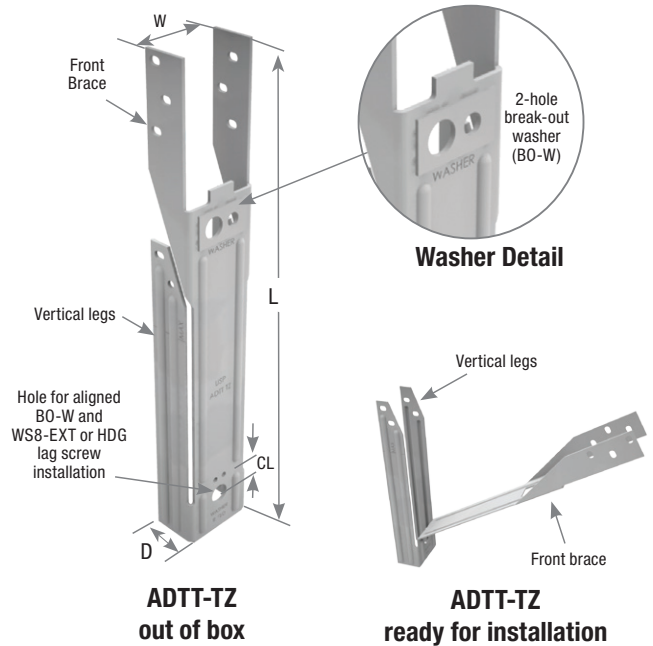
**Installation:**

- Install with MiTek USP WS8-EXT wood screw or 3/8" HDG lag screw. WS8-EXT or 3/8" HDG lag screws may be installed adjacent or up to 4-3/8" below deck joist (see Figure A).
- Drive screw horizontally and aligned vertically with the deck joist into the wall top plate of the main (house) structure.
- Install four (4) of the specified joist fasteners into vertical legs. (Two (2) on each side of deck joist).
- Secure front brace with six (6) specified joist fasteners.
- Re-tighten the WS8-EXT or 3/8" HDG lag screw as needed to fully engage with the ADTT-TZ. **DO NOT OVERDRIVE.** Note: Minimum 3" thread penetration required for proper installation of WS8-EXT or lag screw.
- For detailed installation instructions refer to [MiTek-US.com](http://MiTek-US.com).



**Typical ADTT-TZ full extension installation**  
**Extended Installation**

**Typical ADTT-TZ flush installation**  
**Contracted Installation**



**Figure A**

MiTek USP Stock No.	Ref. No.	Steel Gauge	Dimensions (in)				Fastener Schedule				Installation Type <sup>1</sup>	DF/SP Allowable Tension (Lbs.)		S-P-F Allowable Tension (Lbs.)		Corrosion Finish	Code Ref.
			W	L	D	CL	Wall		Joist			160%	Δ (in) at 160% <sup>2</sup>	160%			
							Qty	Type <sup>3,4,5</sup>	Qty	Type <sup>6,8</sup>							
ADTT-TZ	DTT1Z	14	1-9/16	10-1/2	15/16	3/8	1	3/8" HDG Lag Screw	10	10d x 1-1/2	Contracted	820	0.070	820	IBC, FL, LA		
									10	LL915	Contracted	820	0.121	810			
									10	LL915	Extended	790	0.114	780			
									10	LL915	Extended	790	0.114	780			
							1	WS8-EXT	10	10d x 1-1/2	Contracted	830	0.080	780			
									10	LL915	Contracted	830	0.121	780			
									10	LL915	Extended	790	0.114	780			
									10	LL915	Extended	790	0.114	780			
ADTT-TZKT <sup>7</sup>	DTT1Z-KT	14	1-9/16	10-1/2	15/16	3/8	1	WS8-EXT	10	LL915	Contracted	830	0.121	780	--		
Extended	790	0.114	780	--													

**Corrosion Finish**

- Stainless Steel
- Gold Coat
- HDG
- Triple Zinc

1) Allowable loads are for the ADTT-TZ installed tight to the bottom of the joist (Contracted) or 4" from bottom of joist to ADTT-TZ bend line (Extended).  
 2) Deflections are derived from static, monotonic load tests of devices connected to DF wood members with specified fasteners.  
 3) WS8-EXT is a 1/4" dia. x 8" double barrier coated screw sold by MiTek and must be ordered separately if not purchasing the kit. The minimum thread penetration into the top plate of the wall framing is 3".  
 4) 3/8" HDG Lag Screw is an ASTM A307 Grade A lag screw with a thread diameter of 3/8" and is hot-dip galvanized to ASTM A153 standards. The minimum thread penetration into the top plate of the wall framing is 3". Lag screws are available at your local hardware store and must be purchased separately.  
 5) Check with your siding manufacturer for recommendations for fastening through your siding material.  
 6) LL915 denotes a LumberLok Screw, #9 x 1-3/8" long and must be ordered separately if not purchasing the kit.  
 7) ADTT-TZKT is a kit with (4) ADTT-TZ packaged with WS8-EXT screws and LL915 LumberLok screws.  
 8) Nails: 10d x 1-1/2" nails are 0.148" dia. x 1-1/2" long.  
 New products or updated product information are designated in blue font.

The DTB-TZ Deck Tie Back provides positive anchorage between the deck framing and the exterior wall with a load carrying capacity that exceeds building code requirements. When used in conjunction with MiTek's triple-zinc or gold-coat joist hangers, the DTB-TZ transfers the lateral loads into the exterior wall while the joist hangers support the vertical loads. The DTB-TZ can also be used to reinforce the connection between the rail post and the deck.

**Materials:** 14 gauge

**Finish:** G-185 galvanizing

**Options:** See chart for Corrosion Finish Options

**Codes:** See page 12 for Code Reference Chart

**Installation:**

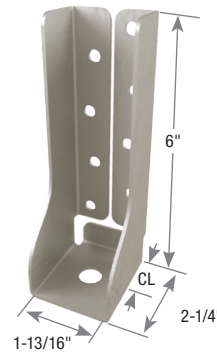
- Use all specified fasteners. See Product Notes, page 20.
- Install with MiTek's THR 1/2" threaded rod or equivalent.
- Drive WS15-EXT wood screws into joist.
- Re-install threaded rod or anchor bolt. Secure with washer and nut.
- Tighten anchor bolt nuts finger tight to base plus 1/3 to 1/2 additional turns with wrench.



**Typical DTB-TZ deck to ledger installation**



**Typical DTB-TZ rail post installation**



**DTB-TZ**

MiTek USP Stock No.	Ref. No.	Steel Gauge	Dimensions (in)				Fastener Schedule				DF/SP Allowable Tension (Lbs.)		S-P-F Allowable Tension (Lbs.)		Corrosion Finish	Code Ref.
			W	L	D	CL	Wall		Joist		160%	Δ (in) at 160% <sup>2</sup>	160%			
							Qty	Bolt <sup>3</sup>	Qty	Screws <sup>1</sup>						
DTB-TZ	DTT2Z, FSC	14	1-13/16	6	2-1/4	1-1/8	1	1/2	8	WS15-EXT	1835	0.119	1510		IBC, FL, LA	

1) WS15-EXT Wood Screws are 1/4" dia. x 1-1/2" long and are included with DTB-TZ Deck Tie-Backs.

2) Deflections are derived from static, monotonic load tests of devices connected to DF wood members with specified fasteners.

3) **Minimum ASTM A307 bolt or 1/2" threaded rod with cut washer and hex nut.**

New products or updated product information are designated in **blue font**.

**Corrosion Finish** ■ Stainless Steel ■ Gold Coat ■ HDG ■ Triple Zinc



**ERB24** – Designed to mount prefabricated fence sections and works with 2x4 horizontal section rails.

**FB26** – Secures 2x6 rails to wood posts.

**FRB24** – Secures continuous 2x4 rails to wood posts. Pre-punched holes allow installers to splice 2x4 rail ends within the bracket.

**Materials:** See chart

**Finish:** G-185 galvanizing

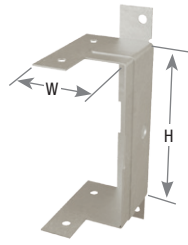
**Codes:** See page 12 for Code Reference Chart

**Installation:**

- Use all specified fasteners.  
See Product Notes, page 20.



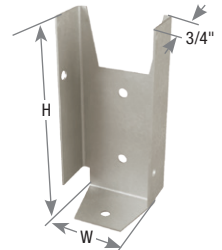
**Typical ERB24-TZ installation**



**ERB24-TZ**



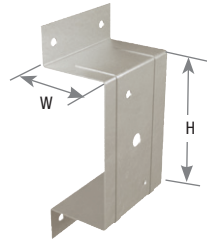
**Typical FB24-TZ installation**



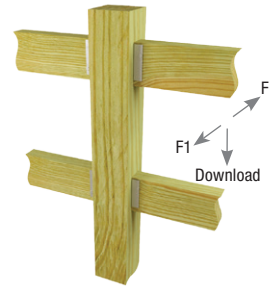
**FB24-TZ**



**Typical FRB24-TZ installation**



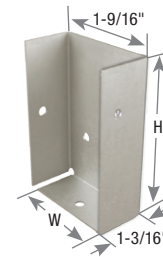
**FRB24-TZ**



**Typical FB26-TZ installation**



**FB26-TZ**



**FB23-TZ**



**FB14-TZ**

Rail Size	MiTek USP Stock No.	Ref. No	Steel Gauge	Dimensions (in)		Fastener Schedule <sup>2</sup>				DF/SP Allowable Loads (Lbs) <sup>1</sup>				Corrosion Finish	Code Ref.
				W	H	Rail		Post		Download		F1			
						Qty	Type	Qty	Type	100%	115%	100%	115%		
1 x 4	FB14-TZ	--	20	3/4	3-1/2	3	14 ga. x 3/4 HDG	2	8d x 1-1/2 HDG	--	--	--	--		
2 x 3	FB23-TZ	--	20	1-9/16	2-3/8	3	8d x 1-1/2 HDG	4	8d x 1-1/2 HDG	--	--	--	--		
2 x 4	ERB24-TZ	--	18	1-1/2	3-9/16	4	8d x 1-1/2 HDG	3	8d HDG	--	--	--	--		
	FB24-TZ	FB24Z, FBR24Z	20	1-9/16	3-3/8	3	8d x 1-1/2 HDG	2	8d HDG	--	--	--	--		--
	FRB24-TZ	--	18	1-9/16	3-9/16	2	10d x 1-1/2 HDG	4	10d HDG	--	--	--	--		
2 x 6	FB26-TZ	FB26	18	1-9/16	5	4	10d x 1-1/2 HDG	4	10d x 1-1/2 HDG	330	330	350	400		
						4	LL915	4	LL915	315	360	315	360		

1) Allowable loads have been increased 15% for short duration loading. No further increase is permitted.

2) **NAILS:** 8d x 1-1/2 nails are 0.131" dia. x 1-1/2" long, 8d nails are 0.131" dia. x 2-1/2" long, 10d x 1-1/2 nails are 0.148" dia. x 1-1/2" long, 10d nails are 0.148" dia. x 3" long, LL915 denotes a LumberLok screw #9 x 1-3/8" long.

**Corrosion Finish** ■ Stainless Steel ■ Gold Coat ■ HDG ■ Triple Zinc

# CSH Concealed Stringer Hanger



The CSH-TZ concealed stringer hanger provides a method of connecting a stair stringer with a hidden hanger. The seat of the hanger is adjustable to match the slope of the stair stringer.

The reversible design allows the connector to be used on the left, right, or interior stringers. The CSH-TZ may be used with MiTek's SCA Stair Angles for a complete, easy-to-use stair framing solution.

**Materials:** 18 gauge

**Finish:** G-185 galvanizing

**Codes:** See page 12 for Code Reference Chart

**Patents:** U.S. Patent No. 7,631,463

**Installation:**

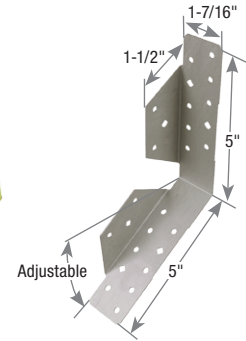
- Use all specified fasteners. See Product Notes, page 20.
- **Bend angle only once.**

**Steps:**

1. Attach CSH-TZ to header with tabs positioned towards the inside of the stringer member.
2. Adjust the seat of the CSH-TZ to match the slope of the stringer member. Diamond shaped holes in the connector allow temporary installation of wood screws to aid in installation of the CSH-TZ.
3. Install 10d (0.148") x 1-1/2" HDG nails into the stringer and rim/band joist.



Typical CSH-TZ installation



CSH-TZ

MiTek USP Stock No.	Ref. No.	Steel Gauge	Fastener Schedule <sup>2</sup>					DF/SP Allowable Loads (Lbs.)				S-P-F/Hem Fir Allowable Loads (Lbs.)				Corrosion Finish	Code Ref.
			Rim/Band Joist		Stringer			100%	115%	125%	Uplift 160%	100%	115%	125%	Uplift 160%		
			Qty	Type	Wide Face Qty	Narrow Face Qty	Type										
CSH-TZ	LSCZ	18	8	10d x 1-1/2 HDG	4	1	10d x 1-1/2 HDG	890	890	890	370	725	725	725	305	IBC, FL, LA	

1) Uplift loads are increased 60% for wind or seismic loads; no further increase shall be permitted.

2) **NAILS:** 10d x 1-1/2 HDG nails are 0.148" dia. x 1-1/2" long.

New products or updated product information are designated in **blue font**.

**Corrosion Finish** ■ Stainless Steel ■ Gold Coat ■ HDG ■ Triple Zinc

# HL Light Gauge Purlin Hangers

These top mount hangers are designed for supporting floor joists or 2x dimensional lumber. The top mount style allows builders to drop in joists or purlins quickly.

**Materials:** 18 gauge

**Finish:** G90 galvanizing

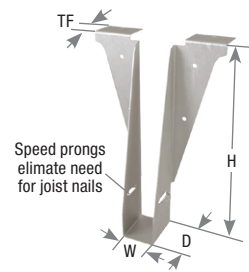
**Codes:** See page 12 for Code Reference Chart

**Installation:**

- Use all specified fasteners. See Product Notes, page 20.



Typical HL210 installation



HL210

With a top mount design and heavy steel fabrication the KB and KLB hangers can cover medium-to-heavy beam and purlin applications. The top mount design offers high loads with less nailing than comparable face mount hangers.

**KLB** – 14 gauge.

**KB** – 12 gauge.

**Materials:** See chart

**Finish:** G90 galvanizing

**Options:** See chart for Corrosion Finish Options

**Codes:** See page 12 for Code Reference Chart

**Installation:**

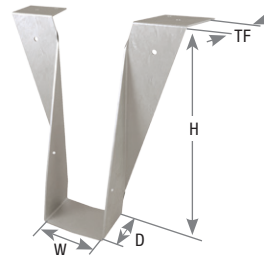
- Use all specified fasteners. See Product Notes, page 20.
- NA20D nails are included with hangers where applicable.
- For welded installations, see page 287.
- **KB models are not recommended for use with LVL, PSL, or LSL members.**



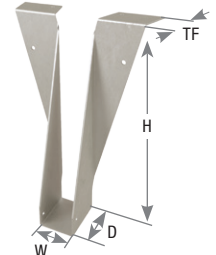
Typical KB installation



Typical KLB installation



KB



KLB

**HDO** Heavy-Duty Top Mount Hangers

Primarily used to hang joists or headers in medium load conditions. These hangers provide higher load values with less nailing.

**Materials:** 12 gauge

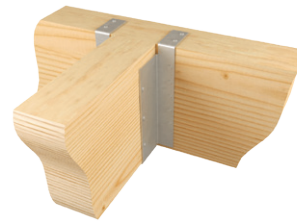
**Finish:** G90 galvanizing

**Options:** All nominal lumber sizes are available for rough/full size lumber. See Specialty Options Chart.

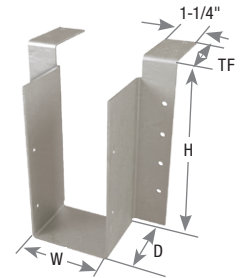
**Codes:** See page 12 for Code Reference Chart

**Installation:**

- Use all specified fasteners. See Product Notes, page 20.
- Check top flange dimensions to ensure compatibility with header widths.
- **Do not use for welded or nailer applications. Reference Specialty Options chart below for hanger options.**



HDO standard installation



HDO28-2



Typical HDO410IF inverted flange installation



Typical HDO skewed option installation

**Specialty Options Chart**

Refer to Specialty Options pages 283 and 285 for additional details.

Option	Skewed <sup>1,3</sup>	Sloped Seat <sup>2</sup>	Sloped / Skewed <sup>1,2,3</sup>	Inverted Flange
<b>Range</b>	1° to 67-1/2° when width is 1-3/4" or less. 1° to 50° on all others.	1° to 45°	See Sloped Seat and Skewed	Not available in widths less than 3-1/8"
<b>Allowable Loads</b>	100% of table load. 75% of uplift load on skews greater than 15°.	100% of table load	80% of table load. 75% of uplift load on skews greater than 15°.	100% of table load. 65% of table load when nailing into the support members end grain.
<b>Ordering</b>	Add <i>SK</i> , angle required, right ( <i>R</i> ) or left ( <i>L</i> ), and square cut ( <i>SQ</i> ) or bevel cut ( <i>BV</i> ) to product number. Ex. HDO210_SK45R_SQ	Add <i>SL</i> , slope required, and up ( <i>U</i> ) or down ( <i>D</i> ), to product number. Ex. HDO210_SL30D	See Sloped Seat and Skewed. Ex. HDO210_SK45R_SQ_SL30D	Add <i>IF</i> to product number. Ex. HDO610_IF

1) Skewed hangers with skews greater than 15° may have all joist nailing on outside flange.  
 2) Sloped or sloped / skewed hangers with slopes greater than 15° may have additional joist nails.  
 3) For skewed hangers, the required cut type (square or bevel) of joist member may vary based on skew angle and width of hanger. Some square cut hangers will require custom pricing due to welded back plate.

**SW** – Light-duty hanger.

**SWH** – Medium-duty hanger.

**KHW** – Heavy-duty hanger installs with NA20D nails for higher load capacities.

**Materials:** SW top flange - 12 gauge; stirrup - 12 gauge;  
 SWH top flange - 7 gauge; stirrup - 12 gauge;  
 KHW top flange - 3 gauge; stirrup - 10 gauge

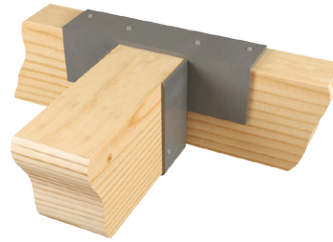
**Finish:** Primer

**Options:** All nominal lumber sizes are available for rough/full size lumber. See Specialty Options below.

**Codes:** See page 12 for Code Reference Chart

**Installation:**

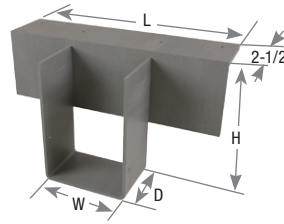
- Use all specified fasteners. See Product Notes, page 20.
- NA20D nails are supplied with KHW hangers.
- For welded installations see page 287.
- **KHW models are not recommended for use with LVL, PSL, or LSL headers.**



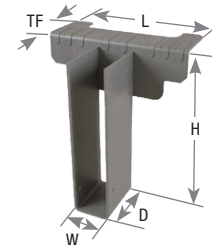
Typical KHW46 installation



Typical SW210 installation



**KHW46**



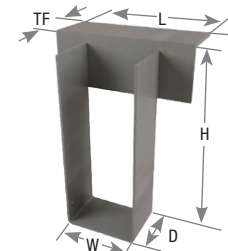
**SW210**

**Nailer Installation Chart**

Chart represents maximum allowable loads for hangers used on wood nailers. Reference page 183.

MiTek USP Series	Nailer Size	Fastener Schedule <sup>3</sup>				DF/SP Allowable Loads (Lbs.) <sup>1</sup>	SPF Allowable Loads (Lbs.) <sup>1</sup>
		Nailer		Joist			
		Qty	Type	Qty	Type		
SW <sup>2</sup> widths ≥ 2-9/16"	2X	2	10d x 1-1/2	2	10d x 1-1/2	1635	1115
	3x	2	16d x 2-1/2	2	10d x 1-1/2	2390	2010
	(2) 2x	2	16d x 2-1/2	2	10d x 1-1/2	2390	2010
	4x	2	16d x 2-1/2	2	10d x 1-1/2	2390	2010
SWH	2X	2	10d x 1-1/2	2	10d x 1-1/2	2600	1770
	3X	2	16d x 2-1/2	2	10d x 1-1/2	3350	2280
	(2) 2x	2	16d x 2-1/2	2	10d x 1-1/2	2600	1770
	4x	2	16d x 2-1/2	2	10d x 1-1/2	2600	1770
KHW	3X	4	16d x 2-1/2	2	10d	5180	3525

- 1) Listed loads shall not be increased.
  - 2) **SW hangers with a width of less than 2-9/16" are limited to 2,315 lbs. of download.**
  - 3) **NAILS:** 10d x 1-1/2 nails are 0.148" dia. x 1-1/2" long, 10d nails are 0.148" dia. x 3" long, 16d x 2-1/2 nails are 0.162" dia. x 2-1/2" long.
- New products or updated product information are designated in **blue font**.



**SWH410**

Hangers

**Specialty Options Chart** – Refer to Specialty Options pages 283, 285-286 for additional details.

Option	Skewed <sup>1,3</sup>	Sloped Seat <sup>2</sup>	Sloped / Skewed <sup>1,2,3</sup>	Sloped Top Flange <sup>4</sup>	Top Flange Offset	Saddle	Ridge								
Range	1° to 84°	1° to 45°	See Sloped Seat and Skewed	0° to 35°	--	--	0° to 45°								
Allowable Loads	100% of table load	100% of table load	100% of table load	100% of table load	<table border="1"> <tr> <th>Hanger Width</th> <th>% of table load:</th> </tr> <tr> <td>3-1/2" or less</td> <td>60%</td> </tr> <tr> <td>3-9/16" to 5-1/2"</td> <td>75%</td> </tr> <tr> <td>5-9/16" to 7-1/2"</td> <td>85%</td> </tr> </table>	Hanger Width	% of table load:	3-1/2" or less	60%	3-9/16" to 5-1/2"	75%	5-9/16" to 7-1/2"	85%	100% of table load per side	100% of table load
Hanger Width	% of table load:														
3-1/2" or less	60%														
3-9/16" to 5-1/2"	75%														
5-9/16" to 7-1/2"	85%														
Ordering	Add SK, angle required, right (R) or left (L), and square cut (SQ) or bevel cut (BV) to product number. Ex. SW212_SK45R_SQ	Add SL, slope required, and up (U) or down (D), to product number. Ex. SW212_SL30D	See Sloped Seat and Skewed. Ex. SW212_SK45R_SQ_SL30D	Add SF, angle required, and right (R) or left (L), to product number. Ex. SW212_SF30L	Add OS, and right (R) or left (L), to product number. Ex. SW212_OSL	Add SA, and saddle width required to product number. Ex. SW212_SA=5-1/2"	Add DA, angle required to product number. Ex. SW212_DA30								

- 1) Skewed hangers with skews greater than 15° may have all joist nailing on outside flange.
- 2) Sloped or sloped / skewed hangers with slopes greater than 15° may have additional joist nails.
- 3) For skewed hangers, the required cut type (square or bevel) of joist member may vary based on skew angle and width of hanger. Some square cut hangers will require custom pricing due to welded back plate.
- 4) Sloped top flanges with greater than 15° may have additional header nails.

Beam/ Joist Size	MiTek USP Stock No.	Ref. No.	Steel Gauge	Dimensions (in)					Fastener Schedule <sup>4</sup>					DF/SP Allowable Loads (Lbs.) <sup>3</sup>				Corrosion Finish	Code Ref.
				W	H	D	L	TF	Header		Joist			Floor	Roof		Uplift <sup>1,2</sup>		
									Qty	Type	Qty	Type	100%		115%	125%			
														Top			Face		
2 x 4	HDO24	HU24TF	12	1-9/16	3-7/16	2-1/4	--	2-1/2	4	2	16d	2	10d x 1-1/2	2405	2440	2460	320		
2 x 6	HL26	JB26	18	1-9/16	5-3/8	1-1/2	--	1-5/16	2	4	16d	2	prongs	1270	1270	1270	--		
	KLB26	LB26	14	1-9/16	5-3/8	1-1/2	--	1-3/8	2	4	16d	2	10d x 1-1/2	1670	1705	1725	390		
	SW26	--	12	1-9/16	5-3/8	2-1/2	6-1/2	2-1/2	2	--	10d	2	10d x 1-1/2	2315	2315	2315	135		
	HDO26	HU26TF	12	1-9/16	5-3/8	2-1/4	--	2-1/2	4	6	16d	4	10d x 1-1/2	2705	2770	2815	800		
2 x 8	HL28	JB28	18	1-9/16	7-5/16	1-3/4	--	1-5/16	2	4	16d	2	prongs	1490	1490	1490	--		
	KLB28	LB28	14	1-9/16	7-1/4	1-3/4	--	1-3/8	2	4	16d	2	10d x 1-1/2	1905	1935	1960	390		
	SW28	--	12	1-9/16	7-1/8	2-1/2	6-1/2	2-1/2	2	--	10d	2	10d x 1-1/2	2315	2315	2315	135		
	HDO28	HU28TF	12	1-9/16	7-1/8	2-1/4	--	2-1/2	4	6	16d	4	10d x 1-1/2	2705	2770	2815	800		
2 x 10	HL210	JB210A	18	1-9/16	9-5/16	2	--	1-5/16	2	4	16d	2	prongs	1490	1490	1490	--		
	KLB210	LB210A	14	1-9/16	9-1/4	2	--	1-3/8	2	4	16d	2	10d x 1-1/2	2140	2170	2195	390		
	SW210	--	12	1-9/16	9-1/8	2-1/2	6-1/2	2-1/2	2	--	10d	2	10d x 1-1/2	2315	2315	2315	135		
	HDO210	HU210TF	12	1-9/16	9-1/8	2-1/4	--	2-1/2	4	8	16d	4	10d x 1-1/2	2705	2770	2815	800		
2 x 12	HL212	JB212A	18	1-9/16	11-1/4	2-5/16	--	1-5/16	2	4	16d	2	prongs	1490	1490	1490	--		
	KLB212	LB212A	14	1-9/16	11-1/8	2	--	1-3/8	2	4	16d	2	10d x 1-1/2	2140	2170	2195	390		
	SW212	--	12	1-9/16	11-1/8	2-1/2	6-1/2	2-1/2	2	--	10d	2	10d x 1-1/2	2315	2315	2315	135		
	HDO212	HU212TF	12	1-9/16	11	2-1/4	--	2-1/2	4	10	16d	6	10d x 1-1/2	3005	3105	3165	1190		
2 x 14	HL214	JB214A	18	1-9/16	13-1/8	2	--	2-1/2	2	6	16d	2	10d x 1-1/2	1490	1490	1490	250		
	SW214	--	12	1-9/16	13-1/8	2-1/2	6-1/2	2-1/2	2	--	10d	2	10d x 1-1/2	2315	2315	2315	135		
	HDO214	HU214TF	12	1-9/16	13	2-1/4	--	2-1/2	4	12	16d	6	10d x 1-1/2	3005	3105	3140	1190		
2 x 16	SW216	--	12	1-9/16	15-1/8	2-1/2	6-1/2	2-1/2	2	--	10d	2	10d x 1-1/2	2315	2315	2315	135		
	HDO216	HU216TF, LB216	12	1-9/16	15	2-1/4	--	2-1/2	4	14	16d	8	10d x 1-1/2	3300	3435	3520	1700		
3 x 4	HDO34	HU34TF	12	2-9/16	3-7/16	2-1/2	--	2-1/2	4	4	16d	2	10d x 1-1/2	2965	2965	2965	320		
3 x 6	SW36	--	12	2-9/16	5-3/8	2-1/2	6-1/2	2-1/2	2	--	10d	2	10d x 1-1/2	2520	2520	2520	135		
	HDO36	HU36TF	12	2-9/16	5-3/8	2-1/2	--	2-1/2	4	6	16d	4	10d x 1-1/2	4125	4320	4450	800		
3 x 8	SW38	--	12	2-9/16	7-1/8	2-1/2	6-1/2	2-1/2	2	--	10d	2	10d x 1-1/2	2520	2520	2520	135		
	HDO38	HU38TF	12	2-9/16	7-1/8	2-1/2	--	2-1/2	4	8	16d	4	10d x 1-1/2	4465	4565	4565	800		
3 x 10	SW310	--	12	2-9/16	9-1/8	2-1/2	6-1/2	2-1/2	2	--	10d	2	10d x 1-1/2	2520	2520	2520	135		
	HDO310	HU310TF	12	2-9/16	9-1/8	2-1/2	--	2-1/2	4	10	16d	6	10d x 1-1/2	4565	4565	4565	1065		
3 x 12	SWH312	--	7/12	2-9/16	11-1/8	2-1/2	7	2-1/2	2	--	16d	2	10d x 1-1/2	3305	3305	3305	135		
	HDO312	HU312TF	12	2-9/16	11	2-1/2	--	2-1/2	4	12	16d	6	10d x 1-1/2	4800	4900	4965	1115		
3 x 14	SWH314	--	7/12	2-9/16	13-1/8	2-1/2	7	2-1/2	2	--	16d	2	10d x 1-1/2	3305	3305	3305	135		
	HDO314	HU314TF	12	2-9/16	13	2-1/2	--	2-1/2	4	14	16d	8	10d x 1-1/2	5100	5230	5315	1115		
3 x 16	SWH316	--	7/12	2-9/16	15-1/8	2-1/2	7	2-1/2	2	--	16d	2	10d x 1-1/2	3305	3305	3305	135		
	HDO316	HU316TF	12	2-9/16	15	2-1/2	--	2-1/2	4	16	16d	8	10d x 1-1/2	5100	5230	5315	1700		
(2) 2 x 4	HDO24-2	HU24-2TF	12	3-1/8	3-7/16	2-1/4	--	2-1/2	4	4	16d	2	10d	2965	2965	2965	400		
(2) 2 x 6	SWH26-2	WP26-2	7/12	3-1/8	5-3/8	2-1/2	7	2-1/2	2	--	16d	2	10d	3305	3305	3305	135		
	HDO26-2	HU26-2TF, HUS26-2TF	12	3-1/8	5-3/8	2-1/4	--	2-1/2	4	6	16d	4	10d	4125	4320	4450	800		
(2) 2 x 8	SWH28-2	WP28-2	7/12	3-1/8	7-1/8	2-1/2	7	2-1/2	2	--	16d	2	10d	3305	3305	3305	135		
	HDO28-2	HU28-2TF, HUS28-2TF	12	3-1/8	7-1/8	2-1/4	--	2-1/2	4	8	16d	4	10d	4465	4565	4565	800		

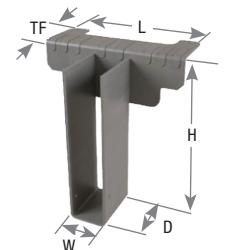
IBC,  
FL,  
LA

Hangers

Copyright © 2019 MiTek Industries, Inc. All Rights Reserved

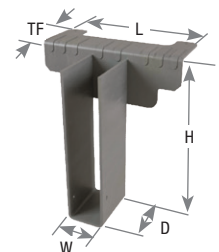
1) Uplift Loads have been increased 60% for wind or seismic loads; no further increase shall be permitted.  
 2) HL products do not provide uplift resistance, except for the HL214.  
 3) Refer to the respective Nail Options chart on page 158 for hangers installed on wood nailers.  
 4) **NAILS:** 10d x 1-1/2 nails are 0.148" dia. x 1-1/2" long, 10d nails are 0.148" dia. x 3" long, 16d nails are 0.162" dia. x 3-1/2" long.

**Corrosion Finish** ■ Stainless Steel ■ Gold Coat ■ HDG ■ Triple Zinc



Beam/ Joist Size	MiTek USP Stock No.	Ref. No.	Steel Gauge	Dimensions (in)					Fastener Schedule <sup>4</sup>					DF/SP Allowable Loads (Lbs.) <sup>2,3</sup>				Code Ref.
				W	H	D	L	TF	Header			Joist		Floor 100%	Roof		Uplift <sup>1</sup> 160%	
									Qty		Type	Qty	Type		115%	125%		
									Top	Face								
(2) 2 x 10	SWH210-2	WP210-2	7/12	3-1/8	9-1/8	2-1/2	7	2-1/2	2	--	16d	2	10d	3305	3305	3305	135	IBC, FL, LA
	HDO210-2	HU210-2TF, HUS210-2TF	12	3-1/8	9-1/8	2-1/2	--	2-1/2	4	10	16d	6	10d	4565	4565	4565	1275	
	HDO210-2IF	HUC210-2TF, HUSC210-2TF	12	3-1/8	9-1/8	2-1/2	--	2-1/2	4	10	16d	6	10d	4565	4565	4565	1275	
(2) 2 x 12	SWH212-2	WP212-2	7/12	3-1/8	11-1/8	2-1/2	7	2-1/2	2	--	16d	2	10d	3305	3305	3305	135	
	HDO212-2	HU212-2TF, HUS212-2TF	12	3-1/8	11	2-1/2	--	2-1/2	4	12	16d	6	10d	5155	5465	5675	1275	
(2) 2 x 14	SWH214-2	WP214-2	7/12	3-1/8	13-1/8	2-1/2	7	2-1/2	2	--	16d	2	10d	3305	3305	3305	135	
	HDO214-2	HU214-2TF, HUS214-2TF	12	3-1/8	13	2-1/2	--	2-1/2	4	14	16d	8	10d	5500	5845	6080	1510	
(2) 2 x 16	SWH216-2	WP216-2	7/12	3-1/8	15-1/8	2-1/2	7	2-1/2	2	--	16d	2	10d	3305	3305	3305	135	
	HDO216-2	HU216-2TF	12	3-1/8	15	2-1/2	--	2-1/2	4	16	16d	8	10d	5845	6010	6100	1700	
4 x 4	HDO44	HU44TF	12	3-9/16	3-7/16	2-1/4	--	2-1/2	4	4	16d	2	10d	2965	2965	2965	400	
4 x 6	SW46	WP46	12	3-9/16	5-3/8	2-1/2	6-1/2	2-1/2	2	--	10d	2	10d	2520	2520	2520	135	
	HDO46	HU46TF	12	3-9/16	5-3/8	2-1/4	--	2-1/2	4	6	16d	4	10d	4125	4320	4450	800	
	KHW46	--	3/10	3-9/16	5-3/8	2-1/2	10	2-1/2	4	--	NA20D	2	10d	5535	5535	5535	135	
4 x 8	SW48	WP48	12	3-9/16	7-1/8	2-1/2	6-1/2	2-1/2	2	--	10d	2	10d	2520	2520	2520	135	
	HDO48	BA48, HU48TF	12	3-9/16	7-1/8	2-1/4	--	2-1/2	4	8	16d	4	10d	4465	4565	4565	800	
	KHW48	--	3/10	3-9/16	7-1/8	2-1/2	10	2-1/2	4	--	NA20D	2	10d	5535	5535	5535	135	
4 x 10	SW410	--	12	3-9/16	9-1/8	2-1/2	6-1/2	2-1/2	2	--	10d	2	10d	2520	2520	2520	135	
	HDO410	BA410, HU410TF	12	3-9/16	9-1/8	2-1/4	--	2-1/2	4	10	16d	6	10d	4785	4785	4785	1275	
	SWH410	WP410	7/12	3-9/16	9-1/8	2-1/2	7	2-1/2	2	--	16d	2	10d	3305	3305	3305	135	
	KHW410	--	3/10	3-9/16	9-1/8	2-1/2	10	2-1/2	4	--	NA20D	2	10d	5535	5535	5535	135	
4 x 12	KB412	--	12	3-9/16	11-1/8	2-3/8	--	2-1/2	4	2	NA20D	2	NA20D	4075	4155	4185	580	
	HDO412	HU412TF	12	3-9/16	11	2-1/4	--	2-1/2	4	12	16d	6	10d	5155	5465	5675	1275	
	SWH412	WP412	7/12	3-9/16	11-1/8	2-1/2	7	2-1/2	2	--	16d	2	10d	3305	3305	3305	135	
	KHW412	--	3/10	3-9/16	11-1/8	2-1/2	10	2-1/2	4	--	NA20D	2	10d	5535	5535	5535	135	
4 x 14	HDO414	HU414TF	12	3-9/16	13	2-1/2	--	2-1/2	4	14	16d	8	10d	5500	5845	6080	1510	
	SWH414	WP414	7/12	3-9/16	13-1/8	2-1/2	7	2-1/2	2	--	16d	2	10d	3305	3305	3305	135	
	KHW414	--	3/10	3-9/16	13-1/8	2-1/2	10	2-1/2	4	--	NA20D	2	10d	5535	5535	5535	135	
4 x 16	HDO416	HU416TF	12	3-9/16	15	2-1/2	--	2-1/2	4	16	16d	8	10d	5845	6230	6435	1700	
	SWH416	WP416	7/12	3-9/16	15-1/8	2-1/2	7	2-1/2	2	--	16d	2	10d	3305	3305	3305	135	
	KHW416	--	3/10	3-9/16	15-1/8	2-1/2	10	2-1/2	4	--	NA20D	2	10d	5535	5535	5535	135	

- 1) Uplift Loads have been increased 60% for wind or seismic loads; no further increase shall be permitted.
- 2) KHW Glulam load values are based on 560 psi perpendicular to grain loading.
- 3) Refer to the respective Nailers Options chart on page 158 for hangers installed on wood nailers.
- 4) **NAILS:** 10d nails are 0.148" dia. x 3" long, 16d nails are 0.162" dia. x 3-1/2" long, NA20D nails are 0.192" dia. x 2-1/2" long and are included with KB and KHW hangers.



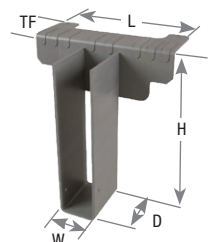
Continued on next page

Beam/ Joist Size	MiTek USP Stock No.	Ref. No.	Steel Gauge	Dimensions (in)					Fastener Schedule <sup>5</sup>					DF/SP Allowable Loads (Lbs.) <sup>2,3</sup>				Code Ref.
				W	H	D	L	TF	Header			Joist		Floor 100%	Roof		Uplift <sup>1</sup> 160%	
									Qty		Type	Qty	Type		115%	125%		
									Top	Face								
(3) 2 x 10	HDO210-3	HU210-3TF	12	4-11/16	9-1/8	2-1/2	--	2-1/2	4	10	16d	6	16d	4565	4565	4565	1450	IBC, FL, LA
(3) 2 x 12	HDO212-3	HU212-3TF	12	4-11/16	11	2-1/2	--	2-1/2	4	12	16d	6	16d	5155	5465	5675	1490	
(3) 2 x 14	HDO214-3	HU214-3TF	12	4-11/16	13	2-1/2	--	2-1/2	4	14	16d	8	16d	5500	5845	6080	1985	
(3) 2 x 16	HDO216-3	HU216-3TF	12	4-11/16	15	2-1/2	--	2-1/2	4	16	16d	8	16d	5845	6230	6435	1985	
6 x 6	HDO66	HU66TF	12	5-1/2	5-3/8	2-1/2	--	2-1/2	4	6	16d	4	16d	4125	4320	4450	990	
	SWH66	WP66	7/12	5-1/2	5-3/8	2-1/2	7	2-1/2	2	--	16d	2	10d	3305	3305	3305	135	
	KHW66	--	3/10	5-1/2	5-3/8	2-1/2	10	2-1/2	4	--	NA20D	2	10d	5535	5535	5535	135	
6 x 8	HDO68	HU68TF	12	5-1/2	7-1/8	2-1/2	--	2-1/2	4	8	16d	4	16d	4465	4565	4565	990	
	SWH68	WP68	7/12	5-1/2	7-1/8	2-1/2	7	2-1/2	2	--	16d	2	10d	3305	3305	3305	135	
	KHW68	--	3/10	5-1/2	7-1/8	2-1/2	10	2-1/2	4	--	NA20D	2	10d	5535	5535	5535	135	
6 x 10	KB610	--	12	5-1/2	9-1/4	2-3/8	--	2-1/2	4	6	NA20D	2	NA20D	4795	4920	4920	580	
	HDO610	HU610TF	12	5-1/2	9-1/8	2-1/2	--	2-1/2	4	10	16d	6	16d	4565	4565	4565	1450	
	SWH610	WP610	7/12	5-1/2	9-1/8	2-1/2	7	2-1/2	2	--	16d	2	10d	3305	3305	3305	135	
	KHW610	--	3/10	5-1/2	9-1/8	2-1/2	10	2-1/2	4	--	NA20D	2	10d	5535	5535	5535	135	
6 x 12	KB612	--	12	5-1/2	11-1/8	2-3/8	--	2-1/2	4	6	NA20D	2	NA20D	4795	4920	4920	580	
	HDO612	HU612TF	12	5-1/2	11	2-1/2	--	2-1/2	4	12	16d	6	16d	5155	5465	5675	1365	
	KHW612	--	3/10	5-1/2	11-1/8	2-1/2	10	2-1/2	4	--	NA20D	2	10d	5535	5535	5535	135	
6 x 14	HDO614	HU614TF	12	5-1/2	13	2-1/2	--	2-1/2	4	14	16d	8	16d	5500	5845	6080	1510	
	KHW614	--	3/10	5-1/2	13-1/8	2-1/2	10	2-1/2	4	--	NA20D	2	10d	5535	5535	5535	135	
6 x 16	HDO616	HU616TF	12	5-1/2	15	2-1/2	--	2-1/2	4	16	16d	8	16d	5845	6230	6435	1830	
	KHW616	--	3/10	5-1/2	15-1/8	2-1/2	10	2-1/2	4	--	NA20D	2	10d	5535	5535	5535	135	
8 x 6	KHW86	--	3/10	7-1/2	5-3/8	2-1/2	10	2-1/2	4	--	NA20D	2	10d	5535	5535	5535	135	
8 x 8	KHW88	--	3/10	7-1/2	7-1/8	2-1/2	10	2-1/2	4	--	NA20D	2	10d	5535	5535	5535	135	
8 x 10	KHW810	--	3/10	7-1/2	9-1/8	2-1/2	10	2-1/2	4	--	NA20D	2	10d	5535	5535	5535	135	
8 x 12	KHW812	--	3/10	7-1/2	11-1/8	2-1/2	10	2-1/2	4	--	NA20D	2	10d	5535	5535	5535	135	
8 x 14	KHW814	--	3/10	7-1/2	13-1/8	2-1/2	10	2-1/2	4	--	NA20D	2	10d	5535	5535	5535	135	
8 x 16	KHW816	--	3/10	7-1/2	15-1/8	2-1/2	10	2-1/2	4	--	NA20D	2	10d	5535	5535	5535	135	
<b>Glulam Sizes<sup>4</sup></b>																		
2-1/2 glulam	KHW26	--	3/10	2-11/16	specify	4	10	2-1/2	4	--	NA20D	2	10d x 1-1/2	5295	5295	5295	135	IBC, FL, LA
3-1/8 glulam	KHW3	--	3/10	3-1/4	specify	3	10	2-1/2	4	--	NA20D	2	10d	5535	5535	5535	135	
5-1/8 glulam	KHW5	--	3/10	5-1/4	specify	2-1/2	10	2-1/2	4	--	NA20D	2	10d	5535	5535	5535	135	

Hangers

Copyright © 2019 MiTek Industries, Inc. All Rights Reserved

- 1) Uplift Loads have been increased 60% for wind or seismic loads; no further increase shall be permitted.
- 2) KHW Glulam load values are based on 560 psi perpendicular to grain loading.
- 3) Refer to the respective Nailer Options chart on page 158 for hangers installed on wood nailers.
- 4) **Consult MiTek for additional Glulam sizes.**
- 5) **NAILS:** 10d x 1-1/2 nails are 0.148" dia. x 1-1/2" long, 10d nails are 0.148" dia. x 3" long, 16d nails are 0.162" dia. x 3-1/2" long, NA20D nails are 0.192" dia. x 2-1/2" long and are included with KHW hangers.



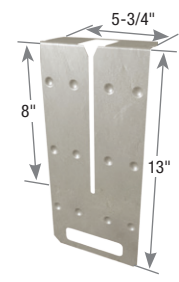
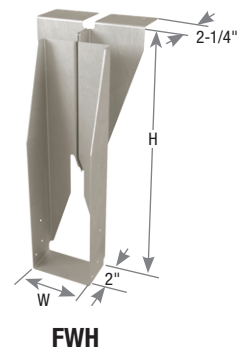
The Fire Wall Hanger is designed for attaching truss, I-joist, solid sawn lumber, or engineered wood floor framing members to double wall top plates or minimum 2-ply 2x solid sawn header fire rated wood frame walls. The advanced design allows the installation of the FWH **before** the 5/8" gypsum wallboard (drywall) is attached and permits the building project to be completely framed-up, and weather-tight before the gypsum wallboard sheathing work starts.

**Materials:** 14 gauge  
**Finish:** G90 galvanizing  
**Options:** See Specialty Options chart on page 161.  
**Codes:** See page 12 for Code Reference Chart  
**Patents:** U.S. Patent No. 10,316,510

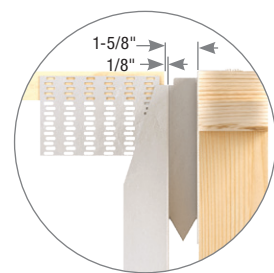
**Installation:**

- Install the face of hanger flanges tight to stud wall framing.
- For wall framing, hangers do NOT need to be installed at stud locations for full design values.
- The end of the truss/joist should measure 1-5/8" from the face of the supporting wall. See Figure 1.
- The truss/joist should bear fully on the FWH seat with a gap no greater than 1/8" between the end of the supported member and the hanger. See Figure 1.
- **Gypsum Wallboard Installation** – Use the FWH-T template to slot cut the gypsum wallboard. See FWH-T Template Sequence. Slide the gypsum wallboard into position and fasten to the framing members meeting the minimum requirements specified by code.

**2 Hour Fire-Rating**  
 FWH hangers are tested per ASTM E814 standards. When installed on one side of a maximum 2 hour fire-rated wall assembly, the penetration of the MiTek FWH Fire Wall Hanger through the gypsum wallboard will not reduce the fire resistive rating of the 2 hour fire resistive assembly.



**FWH-T template**  
(must be ordered separately)



**Figure 1**  
**Typical FWH Side View**

**FWH-T Template Installation Sequence**

1) Align the FWH-Template slot with the mark in the gypsum wallboard and engage the prongs into edge of gypsum wallboard

2) Rotate the template and press down on the end to engage the corner prongs

3) Run the gypsum wallboard cutter down the template to cut the slot

**Fastener / Allowable Load Table**

Installation Type	Fastener Schedule <sup>2</sup>					DF Allowable Loads (Lbs.)								Code Ref.	
	Header		Joist			Solid Sawn Header				2-Ply, 2x Wall Top Plate					
	Top Qty	Face Qty	Type	Qty	Type	Download			Uplift <sup>1</sup>	Download			Uplift <sup>1</sup>		
						100%	115%	125%		100%	115%	125%			160%
Without 5/8" gypsum wallboard or structural sheathing	6	-- 2	10d	6	10d x 1-1/2	2240	2240	2240	180 380	2045	2045	2045	180 380	IBC, FL, LA	
After (1) layer of 5/8" gypsum wallboard is installed	6	-- 2	10d	6	10d x 1-1/2	2400	2400	2400	180 380	2400	2400	2400	180 380		
After (2) layers of 5/8" gypsum wallboard are installed	6	-- 2	10d	6	10d x 1-1/2	2400	2400	2400	180 380	2400	2400	2400	180 380		
Two-sided after (2) layers of 5/8" gypsum wallboard are installed (min. 2x6 wall)	6	-- 2	10d	6	10d x 1-1/2	2400	2400	2400	180 380	2400	2400	2400	180 380		--
After (1) layer of structural sheathing & (1) layer of 5/8" gypsum wallboard is installed	6	-- 2	10d	6	10d x 1-1/2	2400	2400	2400	180 380	2400	2400	2400	180 380		

1) Uplift Loads have been increased 60% for wind or seismic loads; no further increase shall be permitted.  
 2) **NAILS:** 10d x 1-1/2 nails are 0.148" dia. x 1-1/2" long, 10d nails are 0.148" dia. x 3" long.

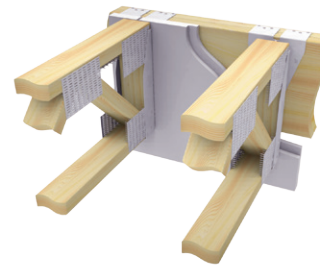
Hangers

Copyright © 2019 MiTek Industries, Inc. All Rights Reserved



**Geometry Table**

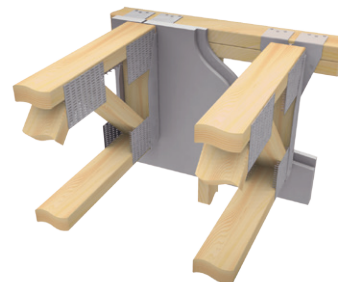
Joist Size (in)	MiTek USP Stock No.	Ref. No.	Dimensions (in)	
			W	H
2 x 8	FWH28	--	1-9/16	7-1/8
2 x 10	FWH210	--	1-9/16	9-1/8
2 x 12	FWH212	--	1-9/16	11-1/8
1-3/4 x 9-1/2	FWH1795	DGHF1.81/9.5	1-13/16	9-7/16
1-3/4 x 11-7/8	FWH17118	DGHF1.81/11.88	1-13/16	11-13/16
1-3/4 x 14	FWH1714	DGHF1.81/14	1-13/16	13-15/16
1-3/4 x 16	FWH1716	DGHF1.81/16	1-13/16	15-15/16
2 - 2-1/8 x 9-1/2	FWH2095	DGHF2.1/9.5	2-1/8	9-7/16
2 - 2-1/8 x 11-7/8	FWH20118	DGHF2.1/11.88	2-1/8	11-13/16
2 - 2-1/8 x 14	FWH2014	DGHF2.1/14	2-1/8	13-15/16
2 - 2-1/8 x 16	FWH2016	DGHF2.1/16	2-1/8	15-15/16
2-5/16 x 9-1/2	FWH2395	DGHF2.37/9.5	2-3/8	9-7/16
2-5/16 x 11-7/8	FWH23118	DGHF2.37/11.88	2-3/8	11-13/16
2-5/16 x 14	FWH2314	DGHF2.37/14	2-3/8	13-15/16
2-5/16 x 16	FWH2316	DGHF2.37/16	2-3/8	15-15/16
2-5/16 x 18	FWH2318	DGHF2.37/18	2-3/8	17-15/16
2-5/16 x 20	FWH2320	DGHF2.37/20	2-3/8	19-15/16
2-1/2 x 9-1/2	FWH2595	DGHF2.56/9.5	2-9/16	9-7/16
2-1/2 x 11-7/8	FWH25118	DGHF2.56/11.88	2-9/16	11-13/16
2-1/2 x 14	FWH2514	DGHF2.56/14	2-9/16	13-15/16
2-1/2 x 16	FWH2516	DGHF2.56/16	2-9/16	15-15/16
2-1/2 x 18	FWH2518	DGHF2.56/18	2-9/16	17-15/16
2-1/2 x 20	FWH2520	DGHF2.56/20	2-9/16	19-15/16
3-1/2 x 9-1/2	FWH3595	DGHF3.62/9.5	3-9/16	9-7/16
3-1/2 x 11-7/8	FWH35118	DGHF3.62/11.88	3-9/16	11-13/16
3-1/2 x 14	FWH3514	DGHF3.62/14	3-9/16	13-15/16
3-1/2 x 16	FWH3516	DGHF3.62/16	3-9/16	15-15/16
3-1/2 x 18	FWH3518	DGHF3.62/18	3-9/16	17-15/16
3-1/2 x 20	FWH3520	DGHF3.62/20	3-9/16	19-15/16
3-1/2 x 22	FWH3522	DGHF3.62/22	3-9/16	21-15/16
3-1/2 x 24	FWH3524	DGHF3.62/24	3-9/16	23-15/16
FWH-Template	FWH-T	--	5-3/4	13



**Typical FWH solid sawn header installation**



**Typical FWH stud wall installation**



**Typical FWH stud wall with (2) layers of 5/8" gypsum wallboard installation**

**Specialty Options Chart** – Refer to Specialty Options pages 283 and 285 for additional details.

Option	Skewed <sup>1</sup>
<b>Range</b>	1° to 70°
<b>Allowable Loads</b>	80% of table load on skews up to 45°. 70% of table load on skews 46° to 70°.
<b>Ordering</b>	Add <i>SK</i> , angle required, right ( <i>R</i> ) or left ( <i>L</i> ), and square cut ( <i>SQ</i> ) to product number. Ex. FWH3514_SK45R_SQ

1) Skewed hangers with skews greater than 15° may have all joist nailing on outside flange.

MiTek has expanded the FWH Fire Wall Hanger series to include the higher load carrying capacity FWHBP, the Fire Wall Hanger for Beams and Purlins. The FWHBP transfers the load into the supporting wall thru bearing on the top plates and directly attaching to the stud pack or post below. As with the FWH hanger, the advanced design allows you to install the hangers before the drywall is attached, allowing your project to be completely framed-up and weather-tight before the drywall sheathing shows up on site.

**Materials:** 12 gauge

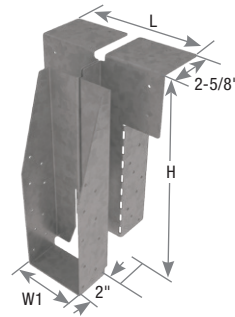
**Finish:** Primer

**Codes:** See page 12 for Code Reference Chart

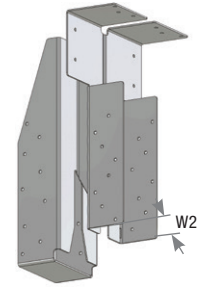
**Patents:** U.S. Patent No. 10,179,992

**Installation:**

- Install the face of hanger flanges tight to stud wall framing.
- The end of the truss/joist should measure 1-5/8" from the face of the supporting wall.
- The truss/joist should bear fully on the FWH seat with a gap no greater than 1/8" between the end of the supported member and the hanger.
- **Gypsum Wallboard Installation** – Use the FWH-T template to slot cut the gypsum wallboard. See FWH-T Template Sequence. Slide the gypsum wallboard into position and fasten to the framing members meeting the minimum requirements specified by code.



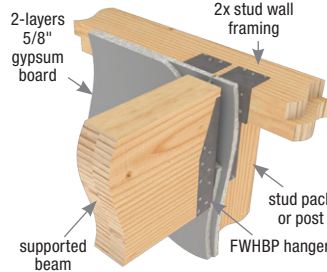
**FWHBP Hanger**



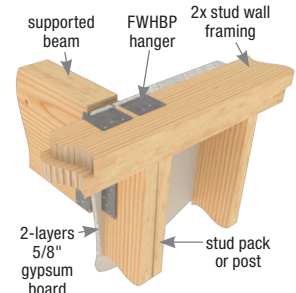
**FWHBP Stud Pack Width**



**FWH-T template**  
(must be ordered separately)



**Typical FWHBP attachment to top plate/beam and stud pack/post**



**FWH-T Template Installation Sequence**

1) Align the FWH-Template slot with the mark in the gypsum wallboard and engage the prongs into edge of gypsum wallboard

2) Rotate the template and press down on the end to engage the corner prongs

3) Run the gypsum wallboard cutter down the template to cut the slot

Joist Size	MiTek USP Stock No.	Ref. No.	Steel Gauge	Dimensions (in)				Fastener Schedule <sup>4</sup>					DF/SP Allowable Loads (Lbs.)				Code Ref.	
				W1	W2 <sup>3</sup>	H	L	Header		Joist			Download					
								Top Qty	Face Qty	Stud Qty	Type	Qty	Type	100%	115%	125%		Uplift 160% <sup>2</sup>
3-1/2 x 11-7/8	FWHBP35118	--	12	3-9/16	Specify	11-7/8	7-1/8	6	4	16	10d	18	10d	7055	7355	7550	3025	--
3-1/2 x 14	FWHBP3514					13-15/16												
3-1/2 x 16	FWHBP3516					15-15/16												
3-1/2 x 18	FWHBP3518					17-15/16												
3-1/2 x 20	FWHBP3520					19-15/16												
3-1/2 x 22	FWHBP3522					21-15/16												
3-1/2 x 24	FWHBP3524	23-15/16																
5-1/4 x 11-7/8	FWHBP52118	--	12	5-3/8	Specify	11-7/8	7-15/16	6	4	16	10d	18	10d	8015	8015	8015	3025	--
5-1/4 x 14	FWHBP5214					13-15/16												
5-1/4 x 16	FWHBP5216					15-15/16												
5-1/4 x 18	FWHBP5218					17-15/16												
5-1/4 x 20	FWHBP5220					19-15/16												
5-1/4 x 22	FWHBP5222					21-15/16												
5-1/4 x 24	FWHBP5224	23-15/16																
7 x 11-7/8	FWHBP71118	--	12	7-1/8	Specify	11-7/8	9-11/16	6	4	16	10d	18	10d	5695	5695	5695	3025	--
7 x 14	FWHBP7114					13-15/16												
7 x 16	FWHBP7116					15-15/16												
7 x 18	FWHBP7118					17-15/16												
7 x 20	FWHBP7120					19-15/16												
7 x 22	FWHBP7122					21-15/16												
7 x 24	FWHBP7124	23-15/16																

1) Download allowable load is for a 2-Ply Top Plate with stud pack (or post) below without wall and floor sheathing attached.  
 2) Uplift loads have been increased 60% for wind or seismic loads. No further increase shall be permitted.  
 3) "Specify" denotes required stud pack/post width must be specified when ordering. Minimum 3".  
 4) **NAILS:** 10d nails are 0.148" dia. x 3" long.

These strap-style hangers are designed to support trusses, joists, or purlins. JH models may be bent along the flange allowing builders to use the hangers in top mount, face mount, or combination applications.

**Materials:** 18 gauge

**Finish:** G90 galvanizing

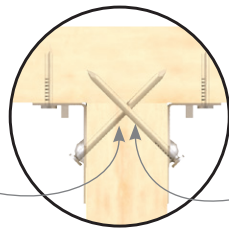
**Codes:** See page 12 for Code Reference Chart

**Installation:**

- Use all specified fasteners. See Product Notes, page 20.
- Joist nails must be driven at a 30° to 45° angle through the joist or truss into the header to achieve listed loads. **Slant/double shear nails must be used to achieve listed load values.**
- If installing in top mount configuration, field bend top flange over header.
- 16d sinkers (0.148" dia. x 3-1/4") may be used where 10d common are specified with no load reduction.

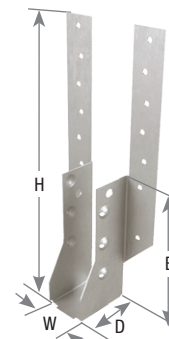


**Typical JH20 installation**



Double shear nail design features fewer nails and faster installation

Uses standard length common nails



**JH20**

Joist Size	MiTek USP Stock No.	Ref. No.	Steel Gauge	Dimensions (in)					Header Size	Fastener Schedule <sup>2,3</sup>					DF/SP Allowable Loads (Lbs.)				Code Ref.
				W	H	D	B	TF		Header		Joist			Floor 100%	Roof		Uplift <sup>1</sup>	
										Top Qty	Face Qty	Type	Qty	Type		115%	125%		
				Qty	Qty	Type	Qty	Type		100%	115%	125%	160%						
2 x 6 - 12	JH20	--	18	1-9/16	10-1/16	2-1/4	5-1/8	1-3/16	2 x 6	2	4	10d	6	10d	1910	2070	2175	1300	IBC, FL, LA
								1-7/16	2 x 8	2	8	10d	6	10d	2555	2780	2935	1300	
								7/16	2 x 10	2	12	10d	6	10d	2295	2595	2790	1300	
								--	2 x 12	--	14	10d	6	10d	2210	2545	2765	1300	

1) Uplift Loads have been increased 60% for wind or seismic loads; no further increase shall be permitted.  
 2) Nails must be driven at a 30° to 45° angle through the joist or truss into header to achieve the table loads.  
 3) **NAILS:** 10d nails are 0.148" dia. x 3" long. 16d sinkers (0.148" dia. x 3-1/4" long) may be used where 10d commons are specified with no reduction in load.

# RR Ridge Rafter Hanger

The RR Ridge Rafter supports rafter pitches up to 7:12 (30°). Nesting top flange for back-to-back installation on 2x support beams.

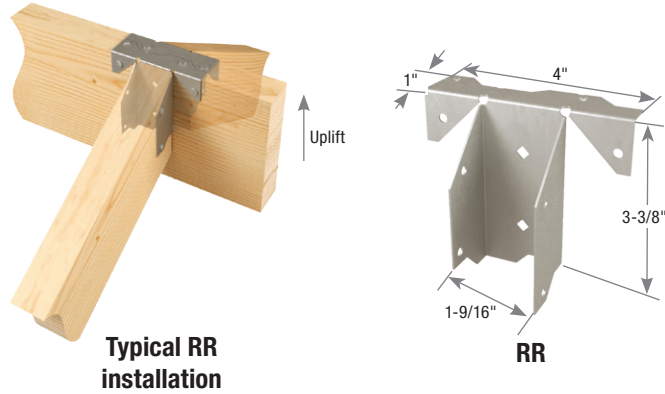
**Materials:** 18 gauge

**Finish:** G90 galvanizing

**Codes:** See page 12 for Code Reference Chart

**Installation:**

- Use all specified fasteners. See Product Notes, page 20.
- The rafter end at the ridge must be plumb cut to achieve published loads.
- Optional diamond nail holes can be used to fasten RR to end of rafter before setting rafter into place.



MiTek USP Stock No.	Ref. No.	Steel Gauge	Min Rafter Size	Fastener Schedule <sup>2</sup>				DF/SP Allowable Loads (Lbs.) <sup>1</sup>				S-P-F Allowable Loads (Lbs.) <sup>1</sup>				Code Ref.
				Header		Rafter		Download		Uplift	Download		Uplift			
				Qty	Type	Qty	Type	100%	115%	125%	160%	100%	115%	125%	160%	
RR	RR	18	2 x 6	4	10d x 1-1/2	4	10d x 1-1/2	365	365	365	205	290	290	290	160	--
				4	LL915	4	LL915	380	380	380	180	320	320	320	150	

1) Allowable loads have been increased 60% for wind or seismic loads; no further increase shall be permitted.

2) **NAILS:** 10d x 1-1/2 nails are 0.148" dia. x 1-1/2" long and LL915 denotes a MiTek LumberLok Screw, #9 x 1-3/8" long.

# LS Light Slope Rafter Hangers

A field-adjustable seat gives the LS hanger application flexibility.

The LS hanger slopes from 0° to 30° down (0 to 7:12 pitch down).

**Materials:** 18 gauge

**Finish:** G90 galvanizing

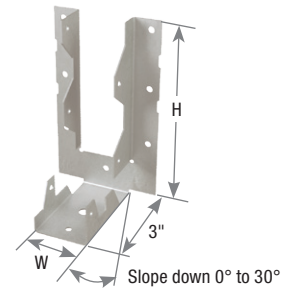
**Codes:** See page 12 for Code Reference Chart

**Installation:**

- Use all specified fasteners. See Product Notes, page 20.
- The LS can be field adjusted to slopes from 0° to 30° down.



Typical LS268 installation



LS268

Joist Size	MiTek USP Stock No.	Ref. No.	Steel Gauge	Dimensions (in)		Fastener Schedule <sup>2</sup>				DF/SP Allowable Loads (Lbs.)				S-P-F Allowable Loads (Lbs.)				Code Ref.
				W	H	Header		Joist		Download		Uplift <sup>1</sup>	Download		Uplift <sup>1</sup>			
						Qty	Type	Qty	Type	100%	115%	125%	160%	100%	115%	125%	160%	
2 x 6 - 8	LS268	--	18	1-9/16	5-1/2	7	10d x 1-1/2	7	10d x 1-1/2	840	965	1050	660	740	850	925	530	IBC, FL, LA
						7	16d			1000	1150	1170	660	880	940	940	530	
2 x 10	LS210	--	18	1-9/16	7-7/8	9	10d x 1-1/2	9	10d x 1-1/2	1080	1240	1350	1035	950	1085	1085	835	IBC, FL, LA
						9	16d			1285	1350	1350	1035	1085	1085	1085	835	

1) Uplift loads are increased 60% for wind or seismic loads; no further increase shall be permitted.

2) **NAILS:** 10d x 1-1/2 nails are 0.148" dia. x 1-1/2" long, 16d nails are 0.162" dia. x 3-1/2" long.

New products or updated product information are designated in **blue font**.

The LSSH series connects rafters to ridge beams in vaulted roof structures. This series is field adjustable to meet a variety of skew and/or slope applications. Slopes and skews 0° to 45°.

**Materials:** See chart

**Finish:** G90 galvanizing; LSSH15-TZ – G-185 galvanizing

**Options:** See Chart for Corrosion Finish Options

**Codes:** See page 12 for Code Reference Chart

**Installation:**

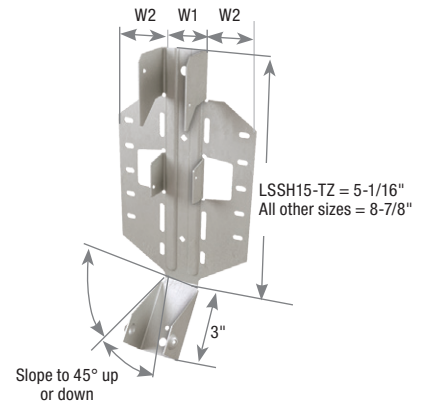
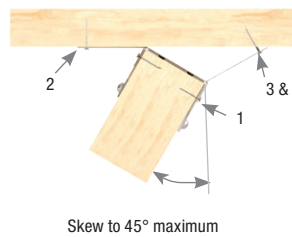
- Use all specified fasteners. See Product Notes, page 20.

**Steps:**

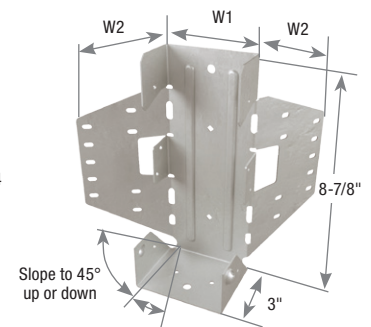
1. Position LSSH connector against plumb-cut end of joist. Fasten joist side flanges on both sides with 10d (0.148" x 1-1/2" nails. Bend seat up to fit against joist bottom and drive (1) 10d (0.148" x 1-1/2" nail through bottom seat into rafter bottom. Drive (2) 10d (0.148" x 1-1/2" nails at downward angle through dimpled nailing guides.
  2. Lean connector and rafter end against ridge beam at desired position. Install specified 10d (0.148" dia. x 3") or 16d (0.162 x 3-1/2") nails through nail holes into ridge beam at right 90° angle. If skewing the rafter, only drive nails into ridge beam on inside flange.
  3. Bend flange to desired angle.
  4. Hammer outside flange until edge touches header. Fasten outside flange to ridge by driving specified 10d (0.148" dia. x 3") or 16d (0.162 x 3-1/2") nails through nail holes.
- Web stiffeners are required for all wood I-Joist installations.
  - Designer may consider adding a tension restraint for the supported member for roof slopes exceeding 6/12. Refer to pages 112-113.



Typical LSSH179 installation



LSSH210



LSSH35

Rafter Width (in)	MiTek USP Stock No.	Ref. No.	Steel Gauge	Dimensions (in)		Fastener Schedule <sup>2</sup>				DF/SP Allowable Loads (Lbs.)				S-P-F Allowable Loads (Lbs.)				Corrosion Finish	Code Ref.
				W1	W2	Header		Rafter		Floor	Roof	Uplift <sup>1</sup>	160%	Floor	Roof	Uplift <sup>1</sup>	160%		
						Qty	Type	Qty	Type										
<b>SLOPED ONLY HANGERS</b>																			
1-1/2	LSSH15-TZ	LSSJ26LZ, LSSJ26RZ, LSSJ28LZ, LSSJ28RZ	18	1-9/16	1-3/4	6	10d HDG	7	10d x 1-1/2 HDG	720	830	900	575	640	730	785	450	IBC, FL	
1-1/2	LSSH210	LSSJ210LZ, LSSJ210RZ	18	1-9/16	1-3/4	10	10d	7	10d x 1-1/2	1200	1380	1395	410	1065	1090	1090	320	IBC, FL, LA	
1-3/4	LSSH179	LSSR1.81Z	18	1-13/16	1-5/8	10	10d	7	10d x 1-1/2	1200	1380	1395	880	1065	1090	1090	690		
2 - 2-1/8	LSSH20	LSSR2.1Z	18	2-1/8	2-1/2	10	10d	7	10d x 1-1/2	1200	1380	1395	795	1065	1085	1085	620	IBC, FL, LA	
2-1/4 - 2-5/16	LSSH23	LSSR2.37Z	18	2-5/16	2-3/8	10	10d	7	10d x 1-1/2	1200	1380	1395	795	1065	1085	1085	620		
2-1/2	LSSH25	LSSR2.56Z	16	2-9/16	2-3/4	18	16d	12	10d x 1-1/2	2095	2095	2095	945	1640	1640	1640	740	IBC, FL, LA	
2-5/8	LSSH26	--	16	2-11/16	2-5/8	18	16d	12	10d x 1-1/2	2095	2095	2095	945	1640	1640	1640	740		
3	LSSH31	LSSR210-2Z	16	3-1/8	3-3/4	18	16d	12	10d x 1-1/2	2645	3045	3100	1310	2345	2425	2425	1025	IBC, FL, LA	
3-1/2	LSSH35	LSSR410Z	16	3-9/16	3-1/2	18	16d	12	10d x 1-1/2	2645	3045	3100	1310	2345	2415	2415	1020		
<b>SKEWED HANGERS or SLOPED &amp; SKEWED HANGERS</b>																			
1-1/2	LSSH15-TZ	LSSJ26LZ, LSSJ26RZ, LSSJ28LZ, LSSJ28RZ	18	1-9/16	1-3/4	6	10d HDG	7	10d x 1-1/2 HDG	625	625	625	515	490	490	490	405	IBC, FL	
1-1/2	LSSH210	LSSJ210LZ, LSSJ210RZ	18	1-9/16	1-3/4	10	10d	7	10d x 1-1/2	1200	1380	1395	880	1065	1090	1090	690	IBC, FL, LA	
1-3/4	LSSH179	LSSR1.81Z	18	1-13/16	1-5/8	10	10d	7	10d x 1-1/2	1200	1380	1395	880	1065	1090	1090	690		
2 - 2-1/8	LSSH20	LSSR2.1Z	18	2-1/8	2-1/2	10	10d	7	10d x 1-1/2	1200	1230	1230	795	960	960	960	620	IBC, FL, LA	
2-1/4 - 2-5/16	LSSH23	LSSR2.37Z	18	2-5/16	2-3/8	10	10d	7	10d x 1-1/2	1200	1230	1230	795	955	955	955	620		
2-1/2	LSSH25	LSSR2.56Z	16	2-9/16	2-3/4	14	16d	12	10d x 1-1/2	1610	1610	1610	945	1260	1260	1260	740	IBC, FL, LA	
2-5/8	LSSH26	--	16	2-11/16	2-5/8	14	16d	12	10d x 1-1/2	1610	1610	1610	945	1260	1260	1260	740		
3	LSSH31	LSSR210-2Z	16	3-1/8	3-3/4	14	16d	12	10d x 1-1/2	1610	1610	1610	1310	1260	1260	1260	1025	IBC, FL, LA	
3-1/2	LSSH35	LSSR410Z	16	3-9/16	3-1/2	14	16d	12	10d x 1-1/2	1610	1610	1610	1310	1255	1255	1255	1020		

1) Uplift loads have been increased 60% for wind or seismic loads; no further increase shall be permitted.  
 2) **NAILS:** 10d x 1-1/2 nails are 0.148" dia. x 1-1/2" long, 10d nails are 0.148" dia. x 3" long, 16d nails are 0.162" dia. x 3-1/2" long. New products or updated product information are designated in blue font.

**Corrosion Finish**

- Stainless Steel
- Gold Coat
- HDG
- Triple Zinc

Copyright © 2019 MiTek Industries, Inc. All Rights Reserved

Hangers

# SKH / SKHH Skewed 45° Hangers



**SKH** – Standard 45° skew hanger allows for a 40° to 50° skew range, without hanger modification.

**SKHH** – For heavier applications.

**Materials:** 14 or 16 gauge

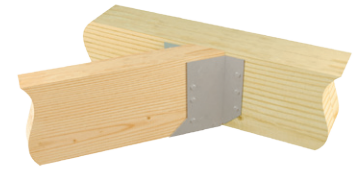
**Finish:** G90 galvanizing

**Options:** See chart for Corrosion Finish Options

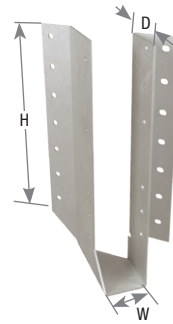
**Codes:** See page 12 for Code Reference Chart



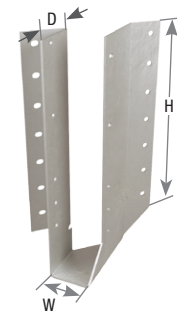
**SKH26R**  
right skew



**SKH26L**  
left skew



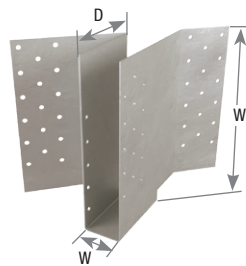
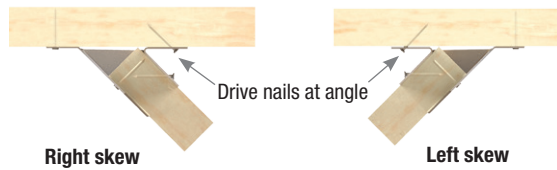
**SKH210R**



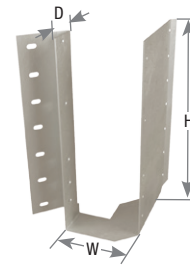
**SKH210L**

**Installation:**

- Use all specified fasteners. See Product Notes, page 20.
- The hangers listed are for standard sizes and will accommodate a 40° to 50° skew range.
- Most sizes do not require a miter cut for installation. Refer to chart footnote identified with an asterisk.
- Illustrations show left and right skews. (SKH\_L = skewed left; SKH\_R = skewed right)
- For I-Joist installations, web stiffeners are required.
- Refer to illustration for staggered I-Joist application for double 2", 2-5/16", and 2-1/2" models.
- For double I-Joist installations, web stiffeners between I-Joists are required.



**SKHH210L**  
left skew



**SKHH210L-2**  
left skew



**Typical SKH26L**  
installation  
left skew

Beam/Joist Size	MiTek USP Stock No.	Ref. No.	Ga.	Dimensions (in)			Fastener Schedule <sup>2</sup>				DF/SP Allowable Loads (Lbs.)				S-P-F Allowable Loads (Lbs.)				Corrosion Finish	Code Ref.
				W	H	D	Header		Joist		100%	115%	125%	160%	100%	115%	125%	160%		
							Qty	Type	Qty	Type										
2 x 4	SKH24L/R	SUR/L24	16	1-9/16	3-1/4	1-7/8	4	16d	4	10d x 1-1/2	510	510	510	545	395	395	395	425	IBC, FL, LA	
2 x 6-8	SKH26L/R	SUR/L26	16	1-9/16	5-1/4	1-7/8	6	16d	6	10d x 1-1/2	840	890	890	1135	700	700	700	980	--	
	SKHH26L/R	--	16	1-5/8	5-1/8	3-1/4	18	16d	12	10d x 1-1/2	1765	1795	1795	795	1450	1450	1450	645	--	
2 x 8-12	SKH28L/R	--	16	1-9/16	7-1/4	1-7/8	10	16d	8	10d x 1-1/2	1400	1465	1465	1350	1160	1160	1160	1070	IBC, FL, LA	
	SKHH28L/R	--	16	1-5/8	7	3-1/4	26	16d	16	10d x 1-1/2	2350	2525	2525	1155	2055	2055	2055	940	--	
2 x 10-14	SKH210L/R	SUR/L210, SUR/L214	16	1-9/16	9-1/4	1-7/8	14	16d	10	10d x 1-1/2	1790	1790	1790	1530	1425	1425	1425	1220	IBC, FL, LA	
	SKHH210L/R	--	16	1-5/8	9	4-1/4	34	16d	20	10d x 1-1/2	2625	2625	2625	1420	2150	2150	2150	1160	--	
1-3/4 x 9-1/4 - 14	SKH1720L/R	SUR/L1.81/9	16	1-13/16	9-1/8	1-7/8	14	10d	10	10d x 1-1/2	1650	1760	1760	1530	1400	1400	1400	1220		
1-3/4 x 11-1/4 - 18	SKH1724L/R	SUR/L1.81/11, SUR/L1.81/14	16	1-13/16	11-1/8	1-7/8	16	10d	10	10d x 1-1/2	1890	2170	2360	1530	1635	1880	2035	1220		
2 - 2-1/8 x 9-1/4 - 14	SKH2020L/R	SUR/L2.06/9, SUR/L2.1/9	16	2-1/8	9	1-7/8	14	10d	10	10d x 1-1/2	1650	1760	1760	1530	1390	1390	1390	1210	IBC, FL, LA	
2 - 2-1/8 x 11-1/4 - 18	SKH2024L/R	SUR/L2.06/11, SUR/L2.1/11	16	2-1/8	11	1-7/8	16	10d	10	10d x 1-1/2	1890	2170	2360	1530	1635	1880	2020	1210		
2-1/4 - 2-5/16 x 9-1/4 - 14	SKH2320L/R	SUR/L2.37/9	16	2-3/8	8-7/8	1-7/8	14	10d	10	10d x 1-1/2	1650	1760	1760	1530	1390	1390	1390	1210		
2-1/4 - 2-5/16 x 11-1/4 - 18	SKH2324L/R	SUR/L2.37/11, SUR/L2.37/14	16	2-3/8	10-7/8	1-7/8	16	10d	10	10d x 1-1/2	1890	2170	2360	1530	1635	1880	2020	1210		

1) Uplift loads have been increased 60% for wind and seismic loads; no further increase shall be permitted.

2) **NAILS:** 10d x 1-1/2 nails are 0.148" dia. x 1-1/2" long, 16d nails are 0.162" dia. x 3-1/2" long.

\*Miter cut required on end of joist to achieve design loads.

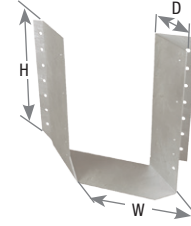
New products or updated product information are designated in **blue font**.

**Corrosion Finish**

- Stainless Steel
- Gold Coat
- HDG
- Triple Zinc



Typical SKH2520R-2 staggered I-joist installation right skew



SKH2520R-2 right skew

Beam/Joist Size	MiTek USP Stock No.	Ref. No.	Ga.	Dimensions (in)			Fastener Schedule <sup>2</sup>				DF/SP Allowable Loads (Lbs.)				S-P-F Allowable Loads (Lbs.)				Corrosion Finish	Code Ref.
				W	H	D	Header		Joist		Allowable Loads (Lbs.)				Allowable Loads (Lbs.)					
							Qty	Type	Qty	Type	Floor	Roof	Uplift <sup>1</sup>	160%	Floor	Roof	Uplift <sup>1</sup>	160%		
3 x 6-8	SKH36L/R	--	16	2-9/16	4-3/4	1-3/8	6	16d	6	10d x 1-1/2	840	965	1050	1135	725	830	830	980		
3 x 8-12	SKH38L/R	--	16	2-9/16	6-3/4	1-3/8	10	16d	8	10d x 1-1/2	1400	1550	1550	1510	1210	1230	1230	1215		
3 x 10-14	SKH310L/R	--	16	2-9/16	8-3/4	1-3/8	14	16d	10	10d x 1-1/2	2060	2365	2465	1530	1780	2045	2090	1220		
3 x 12 - 14 - 16	SKH312L/R	--	16	2-9/16	10-3/4	1-3/8	16	16d	10	10d x 1-1/2	2350	2705	2750	1530	2035	2190	2190	1220		
2-1/2 x 9-1/4 - 14	SKH2520L/R	SUR/L2.56/9	16	2-9/16	8-5/8	1-7/8	14	10d	10	10d x 1-1/2	1650	1760	1760	1530	1380	1380	1380	1205		IBC, FL, LA
2-1/2 x 11-1/4 - 16	SKH2524L/R	SUR/L2.56/11, SUR/L2.56/14	16	2-9/16	10-3/4	1-7/8	16	10d	10	10d x 1-1/2	1890	2170	2360	1530	1635	1880	2010	1205		
2-5/8 x 9-1/4 - 14	SKH2620L/R	--	16	2-11/16	8-11/16	1-7/8	14	10d	10	10d x 1-1/2	1650	1760	1760	1530	1380	1380	1380	1205		
2-5/8 x 11-1/4 - 16	SKH2624L/R	--	16	2-11/16	10-11/16	1-7/8	16	10d	10	10d x 1-1/2	1890	2170	2360	1530	1635	1880	2010	1205		
(2) 2 x 6-8	SKH26L/R-2 *	SUR/L26-2	16	3-1/16	4-1/2	1-3/8	6	16d	6	10d	840	965	1050	1135	725	835	865	980		
	SKHH26L/R-2	HSUR/L26-2	14	3-1/16	5-1/4	2	12	16d	4	16d x 2-1/2	1850	1905	1905	795	1525	1525	1525	635		--
	SKHH26L/R-2IF	HSUR/LC26-2	14	3-1/16	5-1/4	2	12	16d	4	16d x 2-1/2										
(2) 2 x 8-12	SKH28L/R-2 *	--	16	3-1/16	6-1/2	1-3/8	10	16d	8	10d	1400	1610	1750	1350	1210	1395	1515	1060		IBC, FL, LA
(2) 2 x 10-14	SKH210L/R-2 *	SUR/L210-2	16	3-1/16	8-1/2	1-3/8	14	16d	10	10d	1960	2255	2450	1530	1695	1950	2120	1210		
	SKHH210L/R-2	HSUR/L210-2, HSUR/L214-2	14	3-1/16	8-1/2	2	20	16d	6	16d x 2-1/2	3080	3330	3330	2115	2685	2685	2685	1710		--
	SKHH210L/R-2IF	HSUR/LC210-2	14	3-1/16	8-1/2	2	20	16d	6	16d x 2-1/2										
(2) 2 x 12-16	SKH212L/R-2 *	SUR/L214-2	16	3-1/16	10-1/2	1-3/8	16	16d	10	10d	2240	2575	2800	1530	1940	2230	2405	1210		IBC, FL
3-1/2 x 8-14	SKH410L/R *	SUR/L410	14	3-9/16	8-1/2	2-1/2	16	16d	10	16d	2305	2650	2865	1530	1995	2225	2225	1190		
3-1/2 x 12-18	SKH414L/R *	SUR/L414	14	3-9/16	12-1/2	2-1/2	22	16d	10	16d	3170	3645	3960	1530	2740	3150	3425	1190		IBC, FL, LA
4 x 6-8	SKH46L/R *	SUR/L46	14	3-9/16	4-3/4	2-1/2	10	16d	6	16d	1440	1590	1590	1350	1225	1225	1225	1040		
	SKHH46L/R	HSUR/L46	14	3-9/16	5-1/4	2-1/2	12	16d	6	16d	1850	1905	1905	795	1520	1520	1520	635		--
	SKHH46L/RIF	HSUR/LC46	14	3-9/16	5-1/4	2-1/2	12	16d	6	16d										
4 x 10-14	SKH410L/R *	SUR/L410	14	3-9/16	8-1/2	2-1/2	16	16d	10	16d	2305	2650	2865	1530	1995	2225	2225	1190		IBC, FL, LA
	SKHH410L/R	HSUR/L410	14	3-9/16	8-1/2	2-1/2	20	16d	10	16d	3080	3330	3330	2115	2680	2680	2680	1705		--
	SKHH410L/RIF	HSUR/LC410	14	3-9/16	8-1/2	2-1/2	20	16d	10	16d										
4 x 14-18	SKH414L/R *	SUR/L414	14	3-9/16	12-1/2	2-1/2	22	16d	10	16d	3170	3645	3960	1530	2740	3150	3425	1190		IBC, FL, LA
	SKHH414L/R	HSUR/L414	14	3-9/16	12-1/2	2-1/2	26	16d	10	16d	4005	4115	4115	2115	3310	3310	3310	1705		--
	SKHH414L/RIF	HSUR/LC414	14	3-9/16	12-1/2	2-1/2	26	16d	10	16d										
(2) 2 - 2-1/8 x 9-1/4 - 14	SKH2020L/R-2 *	HSUR/L4.12/9, HSUR/L4.28/9	14	4-3/16	9-1/4	3-1/2	14	10d	10	10d	1710	1965	2135	1645	1480	1700	1850	1265		
(2) 2 - 2-1/8 x 11-1/4 - 18	SKH2024L/R-2 *	HSUR/L4.12/11, HSUR/L4.12/14, HSUR/L4.12/16, HSUR/L4.28/11	14	4-3/16	11-1/4	3-1/2	16	10d	10	10d	1950	2245	2440	1680	1690	1945	2110	1295		
(2) 2-5/16 x 9-1/4 - 14	SKH2320L/R-2 *	HSUR/L4.75/9	14	4-7/8	9-1/4	3-1/2	14	10d	10	10d	1710	1965	2135	1645	1480	1700	1850	1265		IBC, FL, LA
(2) 2-5/16 x 11-1/4 - 18	SKH2324L/R-2 *	HSUR/L4.75/11, HSUR/L4.75/14, HSUR/L4.75/16	14	4-7/8	11-1/4	3-1/2	16	10d	10	10d	1950	2245	2440	1680	1690	1945	2110	1295		
(2) 2-1/2 x 9-1/4 - 14	SKH2520L/R-2 *	HSUR/L5.12/9	14	5-1/8	9-1/4	3-1/2	14	10d	10	10d	1710	1965	2135	1645	1480	1700	1850	1265		
(2) 2-1/2 x 11-1/4 - 16	SKH2524L/R-2 *	HSUR/L5.12/11, HSUR/L5.12/14, HSUR/L5.12/16	14	5-1/8	11-1/4	3-1/2	16	10d	10	10d	1950	2245	2440	1680	1690	1945	2110	1295		

1) Uplift loads have been increased 60% for wind and seismic loads; no further increase shall be permitted.

2) **NAILS:** 10d x 1-1/2 nails are 0.148" dia. x 1-1/2" long, 10d nails are 0.148" dia. x 3" long, 16d nails are 0.162" dia. x 3-1/2" long, 16d x 2-1/2 nails are 0.162" dia. x 2-1/2" long.

\*Miter cut required on end of joist to achieve design loads.

New products or updated product information are designated in blue font.

Corrosion Finish ■ Stainless Steel ■ Gold Coat ■ HDG ■ Triple Zinc

Copyright © 2019 MiTek Industries, Inc. All Rights Reserved

Hangers

**KF** – Fastens to joist ends quickly with nails.

**PHG** – Features a gripper design to hold the joist in place with out nailing during the assembly process.

**Materials:** 18 gauge

**Finish:** G90 galvanizing

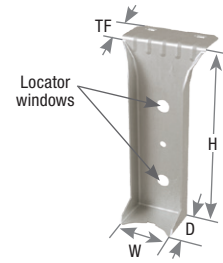
**Codes:** See page 12 for Code Reference Chart

**Installation:**

- Use all specified fasteners. See Product Notes, page 20.
- In panelized construction, installers are allowed to nail through both the sheathing and the hanger top flange with (1) 10d nail. The nail should be centered in the top flange and be no closer than 1/4" from the back or front edge of the top flange.
- Use locator window to center hanger on purlin center line.
- **KF / PHG – These hangers do not provide uplift resistance.**



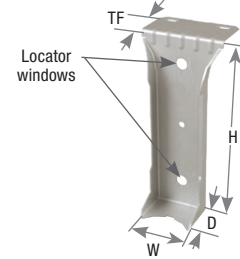
Typical KF installation



KF



Typical PHG26 installation



PHG26

Joist Size	MiTek USP Stock No.	Ref. No.	Steel Gauge	Dimensions (in)				Fastener Schedule <sup>2,3</sup>				DF/SP Allowable Loads (Lbs.) <sup>1</sup>	Code Ref.
				W	H	D	TF <sup>5</sup>	Header		Joist			
								Qty	Type	Qty	Type	125%	
2 x 4	PHG24	HF24N	18	1-9/16	3-1/2	1-3/16	1-1/16	2	8d	--	--	580	IBC, FL, LA
2 x 6	PHG26	HF26N	18	1-9/16	5-3/8	1	1-1/16	2	10d	--	--	650	
3 x 4	PHG34	HF34N	18	2-9/16	3-1/2	1	1-1/8	2	10d	--	--	650	
3 x 6	PHG36	HF36N	18	2-9/16	5-3/8	1	1-1/8	2	10d	--	--	650	
(2) 2 x 4	PHG24-2	F24-2	18	3-1/8	3-1/2	1	1-1/8	2	10d	--	--	650	
(2) 2 x 6	PHG26-2	F26-2	18	3-1/8	5-3/8	1	1-1/8	2	10d	--	--	650	
4 x 4	KF44	F44	18	3-9/16	3-3/8	1	1-1/8	2	10d	1	10d x 1-1/2	695	
4 x 6	KF46	F46	18	3-9/16	5-3/8	1	1-1/8	2	10d	1	10d x 1-1/2	810	

1) Loads listed are per side.

2) **NAILS:** 8d nails are 0.131" dia. x 2-1/2" long, 10d x 1-1/2 nails are 0.148" dia. x 1-1/2" long, 10d nails are 0.148" dia. x 3" long.



**Materials:** 20 gauge

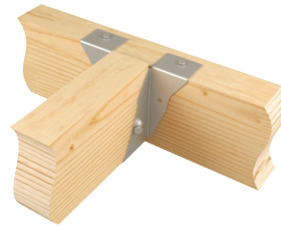
**Finish:** G90 galvanizing

**Options:** See chart for Corrosion Finish Options

**Codes:** See page 12 for Code Reference Chart

**Installation:**

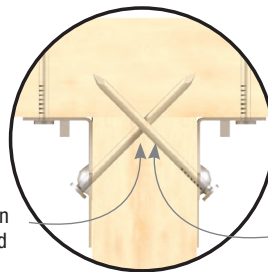
- Use all specified fasteners. See Product Notes, page 20.
- Diamond holes allow optional header nailing.
- Joist nails must be driven at a 30° to 45° angle through the purlin into the header to achieve listed loads. **Slant/double shear nails must be used to achieve listed load values.**
- 16d sinkers (0.148" dia. x 3-1/4") may be used where 10d commons are specified with no load reduction.



**Typical JPF24 installation**

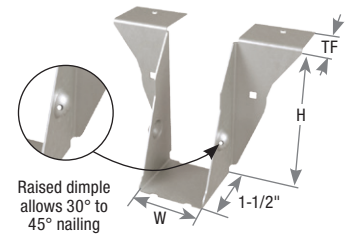


**Typical JPF24 back-to-back installation**



Double shear nail design features fewer nails and faster installation

Uses standard length common nails



**JPF24**

Purlin Size	MiTek USP Stock No.	Ref. No.	GA	Dimensions (in)			Fastener Schedule <sup>3</sup>						DF/SP Allowable Loads (Lbs.)				S-P-F Allowable Loads (Lbs.)			Corrosion Finish	Code Ref.	
				W	H	TF	Min/Max	Header <sup>2</sup>			Joist			Floor			Roof					Uplift <sup>1</sup>
								Top Qty	Face Qty	Type	Qty	Type	100%	115%	125%	160%	100%	115%	125%			
2 x 4	JPF24	PF24	20	1-9/16	3-3/8	1-1/16	Min	2	--	10d	2	10d	1035	1035	1035	315	815	815	815	255	IBC, FL, LA	
							Max	2	2	10d	2	10d	1305	1305	1305	425	995	1040	1040	340		
2 x 6	JPF26	PF26	20	1-9/16	5-3/8	1-1/16	Min	2	--	10d	2	10d	1035	1035	1035	315	815	815	815	255	IBC, FL, LA	
							Max	2	2	10d	2	10d	1305	1305	1305	425	995	1040	1040	340		

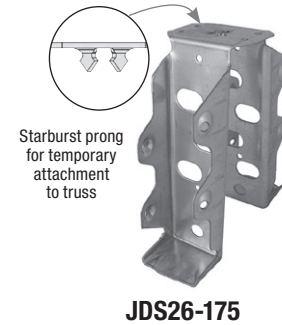
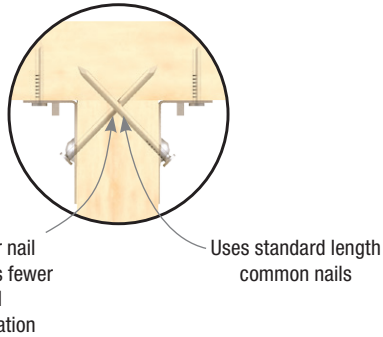
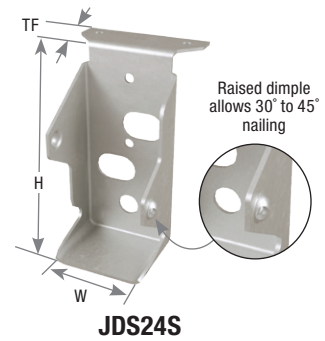
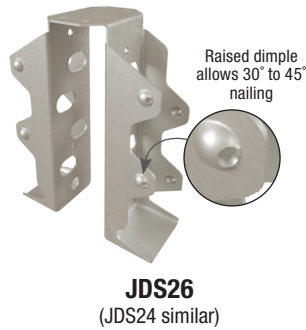
1) Uplift loads have been increased 60% for wind and seismic loads; no further increase shall be permitted.  
 2) JPF cannot be used back to back on a single ply header when optional nailing is used.  
 3) **NAILS:** 10d nails are 0.148" dia. x 3" long.

**Corrosion Finish**  
■ Stainless Steel ■ Gold Coat  
■ HDG ■ Triple Zinc

**Materials:** 18 gauge  
**Finish:** G90 galvanizing  
**Codes:** See page 12 for Code Reference Chart

**Installation:**

- Use all specified fasteners. See Product Notes, page 20.
- Joist nails must be driven at a 30° to 45° angle through the purlin into the header to achieve listed loads. **Slant/double shear nails must be used to achieve listed load values.**



Purlin Size	MiTek USP Stock No.	Ref. No.	Steel Gauge	Dimensions (in)			Fastener Schedule <sup>2</sup>						DF/SP Allowable Loads (Lbs.)				Code Ref.
				W	H	TF	Min/Max	Header		Each Purlin		Floor	Roof		Uplift <sup>1</sup>		
								Top Qty	Face Qty	Type	Qty		Type	100%		115%	
2 x 4 single	JDS24S	PF24B	18	1-9/16	3-1/2	3/4	Min	1	2	10d x 1-1/2	2	10d x 1-1/2	480	480	480	180	--
							Max	2	--		2	10d	575	575	575	340	
2 x 6 single	JDS26S	PF26B	18	1-9/16	5-1/2	3/4	Min	1	2	10d x 1-1/2	4	10d x 1-1/2	550	550	550	355	--
							Max	2	--		4	10d	775	830	835	390	
2 x 4 saddle	JDS24	PFD24B	18	1-9/16	3-1/2	1-9/16	Min	2	4	10d x 1-1/2	2	10d x 1-1/2	960	960	960	365	--
							Max	4	--		2	10d	1155	1155	1155	680	
2 x 6 saddle	JDS26-175	--	18	1-9/16	5-7/16	1-3/4	Min	2	4	10d x 1-1/2	4	10d x 1-1/2	1105	1105	1105	705	--
							Max	4	--		4	10d	1675	1790	1870	950	
	JDS26	PFD26B	18	1-9/16	5-1/2	1-9/16	Min	2	4	10d x 1-1/2	4	10d x 1-1/2	1105	1105	1105	705	
							Max	4	--		4	10d	1575	1670	1670	775	

1) Uplift loads have been increased 60% for wind and seismic loads; no further increase shall be permitted.  
 2) **NAILS:** 10d x 1-1/2 nails are 0.148" dia. x 1-1/2" long, 10d nails are 0.148" dia. x 3" long.

**TUS** – For a single-ply purlin.

**DTUS** – For a single-ply purlin with a 2-ply saddle dimension.

**Materials:** 20 gauge

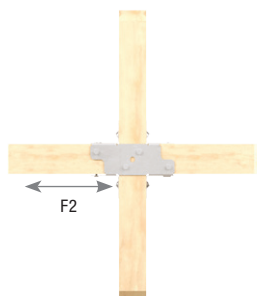
**Finish:** G90 galvanizing

**Codes:** See page 12 for Code Reference Chart

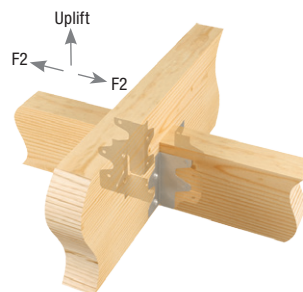
**Patents:** U.S. Patent No. 8,966,857 B2

**Installation:**

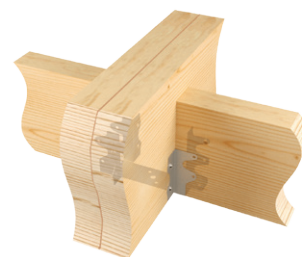
- Use all specified fasteners. See Product Notes, page 20.
- Attaches with standard 1-1/2" joist hanger nails that can be installed with a positive placement nail gun or be hand driven.
- Other 1-1/2" fasteners with a shear value equal or greater than a 10d nail may be used.



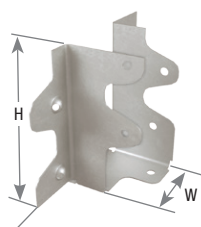
**Bottom View**



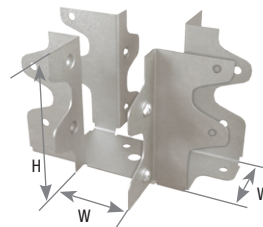
**Typical TUS24 installation**



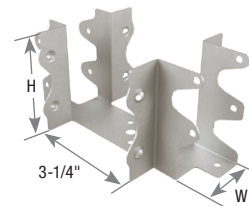
**Typical DTUS24 installation**



**TUS24S**



**TUS24**



**DTUS24**

Joist Size	MiTek USP Stock No.	Ref. No.	Steel Gauge	Dimensions (in)		Fastener Schedule <sup>2,3</sup>						DF/SP Allowable Loads (Lbs.) <sup>1</sup>					Code Ref.
						Header		Joist									
				W	H	Face Qty	Bottom Qty	Type	Face Qty	Bottom Qty	Type	100%	115%	125%	Uplift <sup>1</sup>	F2	
2 x 4 - 6 Single	TUS24S	--	20	1-9/16	3	4	1	8d x 1-1/2	4	1	8d x 1-1/2	485	550	595	505	205	--
								10d x 1-1/2			10d x 1-1/2	580	620	620	505	205	
								LL915			LL915	580	620	620	505	205	
2 x 4 - 6 Saddle	TUS24	--	20	1-9/16	3	4	1	8d x 1-1/2	4	1	8d x 1-1/2	485	550	595	505	645	--
								10d x 1-1/2			10d x 1-1/2	580	620	620	505	645	
								LL915			LL915	580	620	620	505	645	
	DTUS24	--	20	1-9/16	3	4	1	8d x 1-1/2	4	1	8d x 1-1/2	485	550	595	505	645	
								10d x 1-1/2			10d x 1-1/2	580	620	620	505	645	
								LL915			LL915	580	620	620	505	645	

1) Uplift loads have been increased 60% for wind or seismic loads; no further increase shall be permitted.

2) LL915 screws are #9 (0.131" diameter) x 1-1/2" long.

3) **NAILS:** 8d x 1-1/2 nails are 0.131" dia. x 1-1/2" long, 10d x 1-1/2 nails are 0.148" dia. x 1-1/2" long, LL915 screws are #9 (0.131" dia.) x 1-1/2" long.

The FHD26 hanger straddles the header and receives a joist from both sides.

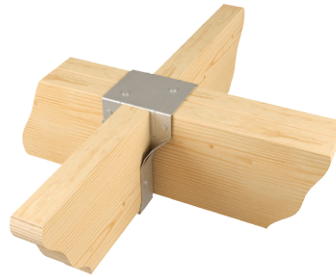
**Materials:** 18 gauge

**Finish:** G90 galvanizing

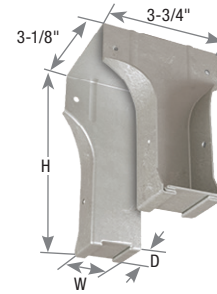
**Codes:** See page 12 for Code Reference Chart

**Installation:**

- Use all specified fasteners. See Product Notes, page 20.
- In panelized construction, installers are allowed to nail through both the sheathing and the hanger top flange with (1) 10d nail. The nail should be centered in the top flange and be no closer than 1/4" from the back or front edge of the top flange.



**Typical FHD26 installation**



**FHD26**

Joist Size	MiTek USP Stock No.	Ref. No.	Steel Gauge	Dimensions (in)			Fastener Schedule <sup>3</sup>				DF/SP Allowable Loads (Lbs.) <sup>1</sup>		Code Ref.		
				W	H	D	Header		Joist		125%	Uplift <sup>2</sup> 160%			
							Qty	Type	Qty	Type					
2 x 6	FHD26	PFDS26	18	1-9/16	5-3/8	1-1/2	2	16d	2	16d	2	10d x 1-1/2	960	175	--

- 1) Loads listed are per side.
- 2) Uplift loads have been increased 60% for wind or seismic loads; no further increase shall be permitted.
- 3) **NAILS:** 10d x 1-1/2 nails are 0.148" dia. x 1-1/2" long, 16d nails are 0.162" dia. x 3-1/2" long. 10d x 1-1/2 nails may be substituted for 16d header nails with a maximum load of 960 lbs.

**WT** Wall Tie

**Materials:** 22 gauge

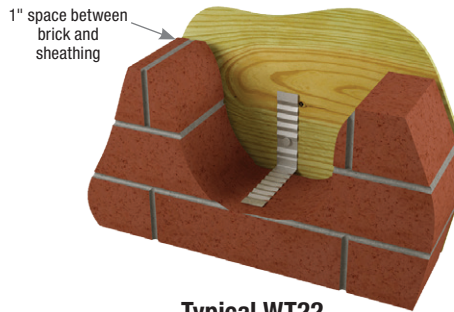
**Finish:** G90 galvanizing

**Options:** See chart for Corrosion Finish Options

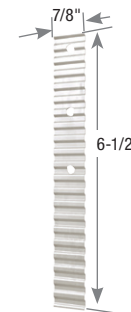
**Codes:** See page 12 for Code Reference Chart

**Installation:**

- Use nails appropriate for intended use. See Product Notes, page 20.
- The opposite end must be bonded in the mortar joint of brick facade.
- Check local codes for spacing requirements.
- Wall tie shall be bent at nail, bonding into mortar joint.



**Typical WT22 installation**



**WT22**

MiTek USP Stock No.	Ref. No.	Description	Steel Gauge	Dimensions (in)		Fastener Schedule <sup>1</sup>		Corrosion Finish	Code Ref.
				W	L	Qty	Type		
WT22	BTB	Straight Edge - Duplex	22	7/8	6-1/2	1	10d	Blue	--

1) **NAILS:** 10d nails are 0.148" dia. x 3" long.

**Corrosion Finish** ■ Stainless Steel ■ Gold Coat ■ HDG ■ Triple Zinc

The HD series Face Mount hangers can be used to connect roof framing members, trusses, and floor joists to masonry walls.

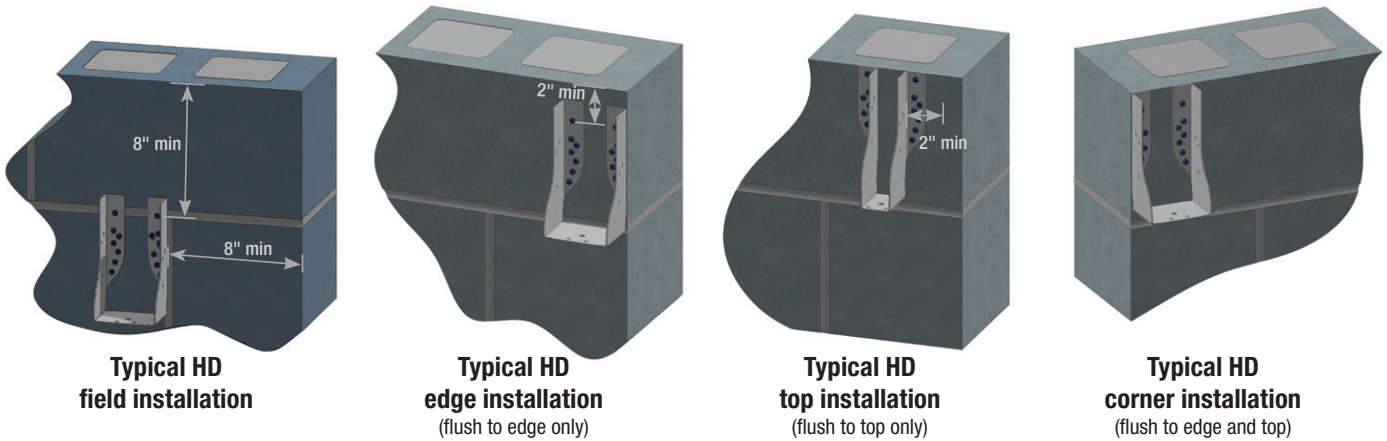
**Materials:** 14 gauge

**Finish:** G90 galvanizing

**Codes:** See page 12 for Code Reference Chart

**Installation:**

- Masonry screws shall be Powers® Tapper+® HWH 3/16" x 1-3/4".



MiTek USP Stock No.	Ref No.	Steel Gauge	Dimensions (in)			Fastener Schedule <sup>2</sup>				DF/SP Allowable Load (Lbs.) <sup>1,4,5,6</sup>								Code Ref.
			W	H	D	Masonry <sup>7</sup>		Joist/Beam		Download (100%)				Uplift (160%)				
						Qty	Tapper+® HWH Screw Anchor	Qty	Type <sup>8</sup>	Field	Edge	Top	Corner	Field	Edge	Top	Corner	
HD26	HU26	14	1-9/16	3-1/2	2-1/2	4	3/16" x 1-3/4"	4	10d x 1-1/2	1000	495	670	335	145	70	145	45	
HD28	HU28	14	1-9/16	5-1/4	2-1/2	8	3/16" x 1-3/4"	6	10d x 1-1/2	2000	990	1340	665	595	295	595	195	
HD210	HU210	14	1-9/16	7-3/16	2-1/2	14	3/16" x 1-3/4"	6	10d x 1-1/2	3110	1545	2085	1035	595	295	595	195	
HD212	--	14	1-9/16	9-13/16	2-1/2	20	3/16" x 1-3/4"	10	10d x 1-1/2	3640	1805	2440	1210	595	295	595	195	
HD26-2	HU26-2	14	3-1/8	5-1/4	2-1/2	12	3/16" x 1-3/4"	6	10d	3000	1490	2015	1000	1170	580	850	380	
HD28-2	HU28-2	14	3-1/8	7-1/8	2-1/2	14	3/16" x 1-3/4"	6	10d	3500	1735	2350	1165	1170	580	850	380	
HD210-2	HU210-2	14	3-1/8	9	2-1/2	20	3/16" x 1-3/4"	10	10d	5000	2480	3355	1665	1950	645	850	420	
HD212-2	HU212-2	14	3-1/8	11	2-1/2	24	3/16" x 1-3/4"	12	10d	5750	2850	3860	1915	2340	645	850	420	
HD44	HU44	14	3-9/16	3-5/16	2-1/2	4	3/16" x 1-3/4"	2	10d	1000	495	670	335	145	70	145	45	
HD46	HU46	14	3-9/16	5-1/16	2-1/2	12	3/16" x 1-3/4"	6	10d	3000	1490	2015	1000	1170	580	850	380	
HD48	HU48	14	3-9/16	6-15/16	2-1/2	14	3/16" x 1-3/4"	6	10d	3500	1735	2350	1165	1170	580	850	380	
HD410	HU410	14	3-9/16	8-13/16	2-1/2	20	3/16" x 1-3/4"	10	10d	5000	2480	3355	1665	1950	645	850	420	
HD412	--	14	3-9/16	10-13/16	2-1/2	24	3/16" x 1-3/4"	12	10d	5750	2850	3860	1915	2340	645	850	420	
HD26-3	HU26-3	14	4-5/8	4-1/2	2-1/2	12	3/16" x 1-3/4"	6	10d	3000	1490	2015	1000	1170	580	850	380	
HD28-3	--	14	4-5/8	6-3/8	2-1/2	14	3/16" x 1-3/4"	6	10d	3500	1735	2350	1165	1170	580	850	380	
HD210-3	HU210-3	14	4-5/8	8-1/4	2-1/2	20	3/16" x 1-3/4"	10	10d	5000	2480	3355	1665	1950	645	850	420	
HD212-3	HU212-3	14	4-5/8	10-1/4	2-1/2	24	3/16" x 1-3/4"	12	10d	5750	2850	3860	1915	2340	645	850	420	
HD5210	--	14	5-3/8	7-7/8	2-1/2	20	3/16" x 1-3/4"	10	10d	5000	2480	3355	1665	2305	645	850	420	
HD5212	--	14	5-3/8	9-7/8	2-1/2	24	3/16" x 1-3/4"	12	10d	5750	2850	3860	1915	2765	645	850	420	
HD66	HU66	14	5-1/2	4-1/16	2-1/2	12	3/16" x 1-3/4"	6	10d	2350	1165	1575	780	1380	645	850	420	
HD68	HU68	14	5-1/2	5-15/16	2-1/2	14	3/16" x 1-3/4"	6	10d	3500	1735	2350	1165	1380	645	850	420	
HD610	HU610	14	5-1/2	7-13/16	2-1/2	20	3/16" x 1-3/4"	10	10d	5000	2480	3355	1665	2305	645	850	420	
HD612	HU612	14	5-1/2	9-13/16	2-1/2	24	3/16" x 1-3/4"	12	10d	5750	2850	3860	1915	2765	645	850	420	

1) Allowable loads assume the use of Powers® Tapper+® HWH 3/16" x 1-3/4".  
 2) Fasteners to be installed per manufacturer's recommendations.  
 3) Field installation indicates that the uppermost and outermost fasteners are a minimum of 8" from the top and side of the masonry wall.  
 4) Edge installation indicates that the hanger is installed flush with the edge of the masonry wall.  
 5) Top installation indicates that the hanger is installed with the hanger flush with the top of the wall.  
 6) Corner installation indicates that the hanger is installed in the corner of the masonry wall flush to the edge, and the top fastener is less than 2" from the top.  
 7) **Minimum 6" wide grout-filled concrete masonry units with a minimum compressive strength of 1,500 psi (10.3 MPa).**  
 8) **NAILS:** 10d x 1-1/2 nails are 0.148" dia. x 1-1/2 long, 10d nails are 0.148 dia. x 3" long.  
 New products or updated product information are designated in **blue font**.

# LGUM / HGUM Masonry Girder Hangers

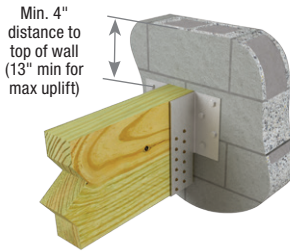
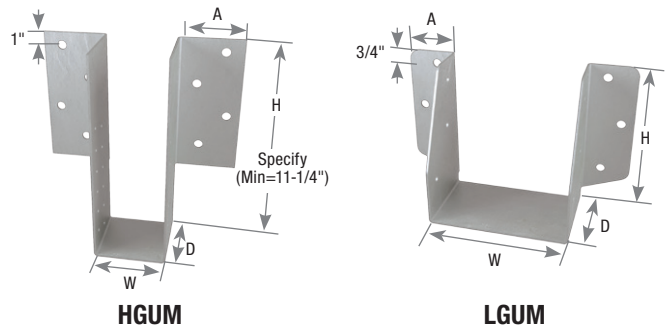


LGUM and HGUM Masonry Girder Hangers are high-capacity beam/girder hangers designed for installation to masonry or concrete walls. The LGUM and HGUM hangers use MiTek USP WS screws (supplied) to attach the beam to hanger and screw anchors (supplied) to attach to the masonry or concrete wall. These hangers eliminate the need for constructing beam pockets.

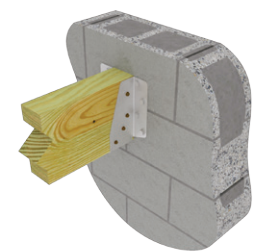
**Materials:** LGUM – 12 gauge; HGUM – 7 gauge  
**Finish:** G90 galvanizing  
**Options:** See Specialty Options chart  
**Codes:** See page 12 for Code Reference Chart

**Installation:**

- WS3 wood screws and screw anchors are supplied with hangers. Substituting other fasteners may reduce capacity.
- Beams comprised of multiple plies must be adequately fastened to act as a single member.
- Beam height dimension (H) must be specified when ordering HGUM hangers.
- Moisture barrier between beam and wall may be required by local jurisdiction.



**Typical HGUM installation**



**Typical LGUM installation**

MiTek USP Stock No.	Ref. No.	Steel Gauge	Dimensions (in.)				Fastener Schedule				DF Allowable Loads (Lbs.) <sup>2</sup>				Code Ref.
			W	H <sup>3</sup>	D	A	CMU/Concrete		Joist		Download (100/115/125%) <sup>1</sup>		Uplift (160%) <sup>1</sup>		
							Qty	Screw Anchor <sup>4</sup>	Qty	Type <sup>5</sup>	CMU 1,500psi	Concrete 2,000 psi	CMU / Concrete		
													4" Min. to Top of Wall	13" Min. to Top of Wall	
<b>Double 2x Sizes</b>															
LGUM26-2	LGUM26-2-SDS	12	3-5/16	5-7/16	4	2-3/8	4	3/8" x 4"	4	WS3	6065	6425	2125	2125	
LGUM28-2	LGUM28-2-SDS	12	3-5/16	7-3/16	4	2-3/8	6	3/8" x 4"	6	WS3	8155	8155	2770	2770	
LGUM210-2	LGUM210-2-SDS	12	3-5/16	9-3/16	4	2-3/8	8	3/8" x 4"	8	WS3	9905	9905	3350	3350	
<b>Triple 2x Sizes</b>															
LGUM26-3	LGUM26-3-SDS	12	4-15/16	5-1/2	4	2-3/8	4	3/8" x 4"	4	WS3	6065	6425	2125	2125	
LGUM28-3	LGUM28-3-SDS	12	4-15/16	7-1/4	4	2-3/8	6	3/8" x 4"	6	WS3	8155	8155	2770	2770	
LGUM210-3	LGUM210-3-SDS	12	4-15/16	9-1/4	4	2-3/8	8	3/8" x 4"	8	WS3	9905	9905	3350	3350	
<b>Quadruple 2x Sizes</b>															
LGUM26-4	LGUM26-4-SDS	12	6-9/16	5-7/16	4	2-3/8	4	3/8" x 4"	4	WS3	6065	6425	2125	2125	
LGUM28-4	LGUM28-4-SDS	12	6-9/16	7-3/16	4	2-3/8	6	3/8" x 4"	6	WS3	8155	8155	2770	2770	
LGUM210-4	LGUM210-4-SDS	12	6-9/16	9-3/16	4	2-3/8	8	3/8" x 4"	8	WS3	9905	9905	3350	3350	
<b>4x Sizes</b>															
LGUM46	LGUM46-SDS	12	3-5/8	4-7/8	4	2-3/8	4	3/8" x 4"	4	WS3	6065	6425	2125	2125	
LGUM48	LGUM48-SDS	12	3-5/8	6-7/8	4	2-3/8	6	3/8" x 4"	6	WS3	8155	8155	2770	2770	
LGUM410	LGUM410-SDS	12	3-5/8	8-7/8	4	2-3/8	8	3/8" x 4"	8	WS3	9905	9905	3350	3350	
<b>Engineered Wood &amp; Structural Lumber Sizes (Heavy Duty)</b>															
HGUM525	HGUM5.25-SDS	7	5-1/4	Specify 11-1/4 to 30	5-1/2	4-3/4	8	5/8" x 5"	24	WS3	16680	16680	4470	10130	
HGUM550	HGUM5.50-SDS	7	5-1/2		5-1/2	4-3/4	8	5/8" x 5"	24	WS3	16680	16680	4470	10130	
HGUM700	HGUM7.00-SDS	7	7		5-1/2	4-3/4	8	5/8" x 5"	24	WS3	16680	16680	4470	10130	
HGUM725	HGUM7.25-SDS	7	7-1/4		5-1/2	4-3/4	8	5/8" x 5"	24	WS3	16680	16680	4470	10130	
HGUM900	HGUM9.00-SDS	7	9		5-1/2	4-3/4	8	5/8" x 5"	24	WS3	16680	16680	4470	10130	

1) Uplift loads have been increased 60% for wind or seismic loads; no further increase shall be permitted.  
 2) Allowable loads assume top header fasteners are a minimum of 4" from the top of the wall.  
 3) "Specify" denotes the required supported beam height that must be specified at the time of ordering.  
 4) Use DeWalt Screw-Bolt™+ (included); or equal, installed in accordance with manufacturer's specification.  
 5) WS3 Wood Screws are 1/4" dia. x 3" long and are included with hangers.

**Specialty Options Chart** – Refer to Specialty Options pages 283 and 285 for additional details.

Option	Inverted Flange
Range	One Inverted-Flange option available
Allowable Loads	50% of table download 75% of table uplift load
Ordering	Add /F and right (R) or left (L) to product number. Ex. HGUM525_H=18_IFL



**Typical HGUM one inverted flange, left shown**

# HWUH Heavy-Duty Welded Universal Hangers

Versatile heavy-duty top flange hanger attaches to both wood and masonry. Unique design allows builders to use one style hanger on the job when the structure has a variety of support materials.

**Materials:** Top Flange – 3 gauge; Stirrup – 7 gauge

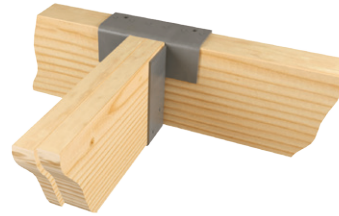
**Finish:** Primer

**Options:** See Specialty Options Chart on page 176.

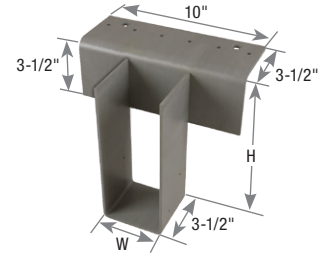
**Codes:** See page 12 for Code Reference Chart

**Installation:**

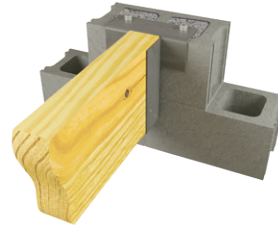
- Use all specified fasteners. See Product Notes, page 20.
- NA21 nails are included with hangers where specified.
- **NA21 nails are not recommended for use with LVL, PSL, or LSL headers.**
- Masonry design load values apply to both solid concrete tie beams and grout-filled CMU walls.
- Alternate installation – Use (2) 1/2" x 4" DeWalt Screw-Bolt+™ or equal for loads up to 2,400 lbs. when attaching to CMU. Loads shall not exceed table loads.



Typical HWUH410 wood-to-wood installation



HWUH



Typical HWUH410 wood-to-masonry installation

Beam/ Joist Size	MiTek USP Stock No.	Ref. No.	Dimensions (in)		Installation Type	Fastener Schedule <sup>2</sup>				DF/SP Allowable Loads (Lbs.)				Code Ref.
			W	H		Supporting Member		Supported Member		Allowable Loads (Lbs.)				
						Wood				Floor	Roof		Uplift <sup>1</sup>	
					Qty	Type	Qty	Type	100%	115%	125%	160%		
2 x 4 - 6	HWUH26	--	1-5/8	5-3/8	Wood	6	10d	4	10d x 1-1/2	3925	4020	4085	955	--
					Masonry	2	1/2" x 6" J-Bolt			3060	3060	3060	1030	
2 x 8	HWUH28	--	1-5/8	7-1/8	Wood	6	10d	4	10d x 1-1/2	3925	4020	4085	955	
					Masonry	2	1/2" x 6" J-Bolt			3060	3060	3060	1030	
2 x 10	HWUH210	--	1-5/8	9-1/8	Wood	6	10d	4	10d x 1-1/2	3925	4020	4085	955	
					Masonry	2	1/2" x 6" J-Bolt			3060	3060	3060	1030	
2 x 12	HWUH212	--	1-5/8	11	Wood	6	10d	4	10d x 1-1/2	3925	4020	4085	955	
					Masonry	2	1/2" x 6" J-Bolt			3060	3060	3060	1030	
2 x 14	HWUH214	--	1-5/8	13	Wood	6	10d	4	10d x 1-1/2	3925	4020	4085	955	
					Masonry	2	1/2" x 6" J-Bolt			3060	3060	3060	1030	
2 x 16	HWUH216	--	1-5/8	16	Wood	6	10d	4	10d x 1-1/2	3925	4020	4085	955	
					Masonry	2	1/2" x 6" J-Bolt			3060	3060	3060	1030	
3 x 6	HWUH36	--	2-5/8	5-3/8	Wood	6	10d	4	10d	4615	4615	4615	955	
					Masonry	2	1/2" x 6" J-Bolt			3060	3060	3060	1030	
3 x 8	HWUH38	--	2-5/8	7-1/8	Wood	6	10d	4	10d	4615	4615	4615	955	
					Masonry	2	1/2" x 6" J-Bolt			3060	3060	3060	1030	
3 x 10	HWUH310	--	2-5/8	9-1/8	Wood	6	10d	4	10d	4615	4615	4615	955	
					Masonry	2	1/2" x 6" J-Bolt			3060	3060	3060	1030	
3 x 12	HWUH312	--	2-5/8	11	Wood	6	10d	4	10d	4615	4615	4615	955	
					Masonry	2	1/2" x 6" J-Bolt			3060	3060	3060	1030	
3 x 14	HWUH314	--	2-5/8	13	Wood	6	10d	4	10d	4615	4615	4615	955	
					Masonry	2	1/2" x 6" J-Bolt			3060	3060	3060	1030	
3 x 16	HWUH316	--	2-5/8	16	Wood	6	10d	4	10d	4615	4615	4615	955	
					Masonry	2	1/2" x 6" J-Bolt			3060	3060	3060	1030	
(2) 2 x 6	HWUH26-2	--	3-1/8	5-3/8	Wood	6	10d	4	10d	4615	4615	4615	955	
					Masonry	2	1/2" x 6" J-Bolt			3060	3060	3060	1030	
(2) 2 x 8	HWUH28-2	--	3-1/8	7-1/8	Wood	6	10d	4	10d	4615	4615	4615	955	
					Masonry	2	1/2" x 6" J-Bolt			3060	3060	3060	1030	
(2) 2 x 10	HWUH210-2	--	3-1/8	9-1/8	Wood	6	10d	4	10d	4615	4615	4615	955	
					Masonry	2	1/2" x 6" J-Bolt			3060	3060	3060	1030	
(2) 2 x 12	HWUH212-2	--	3-1/8	11	Wood	6	10d	4	10d	4615	4615	4615	955	
					Masonry	2	1/2" x 6" J-Bolt			3060	3060	3060	1030	
(2) 2 x 14	HWUH214-2	--	3-1/8	13	Wood	6	10d	4	10d	4615	4615	4615	955	
					Masonry	2	1/2" x 6" J-Bolt			3060	3060	3060	1030	
(2) 2 x 16	HWUH216-2	--	3-1/8	16	Wood	6	10d	4	10d	4615	4615	4615	955	
					Masonry	2	1/2" x 6" J-Bolt			3060	3060	3060	1030	

1) Uplift loads have been increased 60% for wind or seismic loads; no further increase shall be permitted.  
 2) **NAILS:** 10d nails are 0.148" dia. x 3" long.

Beam/ Joist Size	MiTek USP Stock No.	Ref. No.	Dimensions (in)		Installation Type	Fastener Schedule <sup>2</sup>				DF/SP Allowable Loads (Lbs.)				Code Ref.
			W	H		Supporting Member		Supported Member		100%	115%	125%	160%	
						Wood		Qty	Type					
						Qty	Type							
4 x 6	HWUH46	--	3-9/16	5-3/8	Wood	6	NA21	4	10d	5265	5265	5265	675	
					Masonry	2	1/2" x 6" J-Bolt			3060	3060	3060	1030	
4 x 8	HWUH48	--	3-9/16	7-1/8	Wood	6	NA21	4	10d	5265	5265	5265	675	
					Masonry	2	1/2" x 6" J-Bolt			3060	3060	3060	1030	
4 x 10	HWUH410	--	3-9/16	9-1/8	Wood	6	NA21	4	10d	5265	5265	5265	675	
					Masonry	2	1/2" x 6" J-Bolt			3060	3060	3060	1030	
4 x 12	HWUH412	--	3-9/16	11	Wood	6	NA21	4	10d	5265	5265	5265	675	
					Masonry	2	1/2" x 6" J-Bolt			3060	3060	3060	1030	
4 x 14	HWUH414	--	3-9/16	13	Wood	6	NA21	4	10d	5265	5265	5265	675	
					Masonry	2	1/2" x 6" J-Bolt			3060	3060	3060	1030	
4 x 16	HWUH416	--	3-9/16	16	Wood	6	NA21	4	10d	5265	5265	5265	675	
					Masonry	2	1/2" x 6" J-Bolt			3060	3060	3060	1030	
6 x 6	HWUH66	--	5-1/2	5-3/8	Wood	6	NA21	4	10d	5265	5265	5265	675	
					Masonry	2	1/2" x 6" J-Bolt			3060	3060	3060	1030	
6 x 8	HWUH68	--	5-1/2	7-1/8	Wood	6	NA21	4	10d	5265	5265	5265	675	
					Masonry	2	1/2" x 6" J-Bolt			3060	3060	3060	1030	
6 x 10	HWUH610	--	5-1/2	9-1/8	Wood	6	NA21	4	10d	5265	5265	5265	675	
					Masonry	2	1/2" x 6" J-Bolt			3060	3060	3060	1030	
6 x 12	HWUH612	--	5-1/2	11	Wood	6	NA21	4	10d	5265	5265	5265	675	
					Masonry	2	1/2" x 6" J-Bolt			3060	3060	3060	1030	
6 x 14	HWUH614	--	5-1/2	13	Wood	6	NA21	4	10d	5265	5265	5265	675	
					Masonry	2	1/2" x 6" J-Bolt			3060	3060	3060	1030	
6 x 16	HWUH616	--	5-1/2	16	Wood	6	NA21	4	10d	5265	5265	5265	675	
					Masonry	2	1/2" x 6" J-Bolt			3060	3060	3060	1030	
8 x 6	HWUH86	--	7-1/2	5-3/8	Wood	6	NA21	4	10d	5265	5265	5265	675	
					Masonry	2	1/2" x 6" J-Bolt			3060	3060	3060	1030	
8 x 8	HWUH88	--	7-1/2	7-1/8	Wood	6	NA21	4	10d	5265	5265	5265	675	
					Masonry	2	1/2" x 6" J-Bolt			3060	3060	3060	1030	
8 x 10	HWUH810	--	7-1/2	9-1/8	Wood	6	NA21	4	10d	5265	5265	5265	675	
					Masonry	2	1/2" x 6" J-Bolt			3060	3060	3060	1030	
8 x 12	HWUH812	--	7-1/2	11	Wood	6	NA21	4	10d	5265	5265	5265	675	
					Masonry	2	1/2" x 6" J-Bolt			3060	3060	3060	1030	
8 x 14	HWUH814	--	7-1/2	13	Wood	6	NA21	4	10d	5265	5265	5265	675	
					Masonry	2	1/2" x 6" J-Bolt			3060	3060	3060	1030	
8 x 16	HWUH816	--	7-1/2	16	Wood	6	NA21	4	10d	5265	5265	5265	675	
					Masonry	2	1/2" x 6" J-Bolt			3060	3060	3060	1030	

- 1) Uplift loads have been increased 60% for wind or seismic loads; no further increase shall be permitted.
- 2) **NAILS:** NA21 nails are 0.192" dia. x 1-3/4" long and are included with 4x, 6x, and 8x HWUH hangers.

**Specialty Options Chart**

Refer to Specialty Options pages 283 and 285-286 for additional details.

Option	Skewed <sup>1,3</sup>	Sloped Seat <sup>2</sup>	Sloped / Skewed <sup>1,2,3</sup>	Top Flange Offset		Saddle
Range	1° to 45°	1° to 45°	See Sloped Seat and Skewed	--		--
Allowable Loads	100% of table load	100% of table load	100% of table load	Hanger Width 3-1/2" or less 3-9/16" to 5-1/2" 5-9/16" to 7-1/2"	% of table load: 60% 75% 85%	100% of table load per side
Ordering	Add <i>SK</i> , angle required, right ( <i>R</i> ) or left ( <i>L</i> ), and square cut ( <i>SQ</i> ) or bevel cut ( <i>BV</i> ) to product number. Ex. HWUH410_SK45R_SQ	Add <i>SL</i> , slope required, and up ( <i>U</i> ) or down ( <i>D</i> ), to product number. Ex. HWUH410_SL30D	See Sloped Seat and Skewed. Ex. HWUH410_SK45R_SL30D	Add <i>OS</i> , and right ( <i>R</i> ) or left ( <i>L</i> ), to product number. Ex. HWUH410_OL		Add <i>SA</i> , and saddle width required to product number. Ex. HWUH410_SA=5-1/2"

- 1) Skewed hangers with skews greater than 15° may have all joist nailing on outside flange.
- 2) Sloped or sloped / skewed hangers with slopes greater than 15° may have additional joist nails.
- 3) For skewed hangers, the required cut type (square or bevel) of joist member may vary based on skew angle and width of hanger. Some square cut hangers will require custom pricing due to welded back plate.



These hangers are designed to support standard lumber joists, I-joists, or beams. Easy installation into concrete block walls makes the MPH an attractive alternative to fabricating seats in masonry (or attaching ledgers) to support joists or beams.

**Materials:** 12 gauge

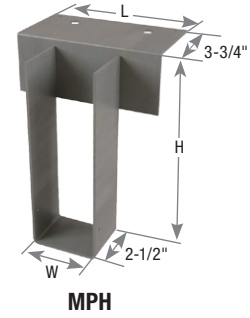
**Finish:** Primer

**Options:** All nominal lumber sizes are available for rough full size lumber. See Specialty Options Chart on page 178.

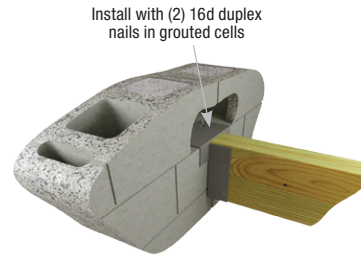
**Codes:** See page 12 for Code Reference Chart



**Typical MPH single-ply installation**



**MPH**



**Typical MPH double-ply installation**

**Installation:**

- Use all specified fasteners. See Product Notes, page 20.
- 16d duplex nails are not supplied with MPH hangers.
- Place hanger into position on top of concrete block. Install (2) 16d duplex nails (0.162" dia. x 3-1/2" double head) through the top flange nail holes. Then continue laying the next course of block.
- A minimum of one course shall be laid over hanger top flange and one course below hanger top flange. Courses adjacent to the top flange shall be subsequently grouted.
- **These products do not provide uplift resistance.**

Beam/ Joist Size	MiTek USP Stock No.	Ref. No.	Steel Gauge	Dimensions (in)			Fastener Schedule <sup>2</sup>				DF/SP Allowable Loads (Lbs.) <sup>1</sup>			Code Ref.
				W	H	L	Block		Joist		Floor	Roof		
							Qty	Type	Qty	Type		100%	115%	
<b>Standard Lumber Sizes</b>														
2 x 10	MPH210	WMU1.56/9.25	12	1-9/16	9-1/4	7	2	16d duplex	2	10d x 1-1/2	2585	2620	2645	IBC, FL, LA
2 x 12	MPH212	WMU1.56/11.25	12	1-9/16	11-1/4	7	2	16d duplex	2	10d x 1-1/2	2585	2620	2645	
2 x 14	MPH214	WMU1.56/14	12	1-9/16	13-1/8	7	2	16d duplex	2	10d x 1-1/2	2585	2620	2645	
2 x 16	MPH216	WMU1.56/16	12	1-9/16	15-1/8	7	2	16d duplex	2	10d x 1-1/2	2585	2620	2645	
(2) 2 x 10	MPH210-2	WMU3.12/9.25	12	3-1/8	9-1/4	7	2	16d duplex	2	10d	4280	4280	4280	
(2) 2 x 12	MPH212-2	WMU3.12/11.25	12	3-1/8	11-1/4	7	2	16d duplex	2	10d	4280	4280	4280	
(2) 2 x 14	MPH214-2	WMU3.12/14	12	3-1/8	13-1/8	7	2	16d duplex	2	10d	4280	4280	4280	
(2) 2 x 16	MPH216-2	WMU3.12/16	12	3-1/8	15-1/8	7	2	16d duplex	2	10d	4280	4280	4280	
3 x 10	MPH310	WMU2.56/9.25	12	2-9/16	9-1/4	7	2	16d duplex	2	10d x 1-1/2	3240	3240	3240	
3 x 12	MPH312	WMU2.56/11.25	12	2-9/16	11-1/4	7	2	16d duplex	2	10d x 1-1/2	3240	3240	3240	
3 x 14	MPH314	WMU2.56/13.25	12	2-9/16	13-1/8	7	2	16d duplex	2	10d x 1-1/2	3240	3240	3240	
3 x 16	MPH316	WMU2.56/15.25	12	2-9/16	15-1/8	7	2	16d duplex	2	10d x 1-1/2	3240	3240	3240	
4 x 10	MPH410	WMU3.56/9.25	12	3-9/16	9-1/4	7	2	16d duplex	2	10d	4280	4280	4280	
4 x 12	MPH412	WMU3.56/11.25	12	3-9/16	11-1/4	7	2	16d duplex	2	10d	4280	4280	4280	
4 x 14	MPH414	WMU3.56/13.25	12	3-9/16	13-1/8	7	2	16d duplex	2	10d	4280	4280	4280	
4 x 16	MPH416	WMU3.56/15.25	12	3-9/16	15-1/8	7	2	16d duplex	2	10d	4280	4280	4280	
6 x 10	MPH610	WMU5.50/9.5	12	5-9/16	9-1/4	7	2	16d duplex	2	10d	4280	4280	4280	
<b>Engineered Lumber Sizes</b>														
1-1/2 x 9-1/4	MPH210	WMU1.56/9.25	12	1-9/16	9-1/4	7	2	16d duplex	2	10d x 1-1/2	2585	2620	2645	IBC, FL, LA
1-1/2 x 9-1/2	MPH1595	WMU1.56/9.5	12	1-9/16	9-1/2	7	2	16d duplex	2	10d x 1-1/2	2585	2620	2645	
1-1/2 x 11-1/4	MPH212	WMU1.56/11.25	12	1-9/16	11-1/4	7	2	16d duplex	2	10d x 1-1/2	2585	2620	2645	
1-1/2 x 11-7/8	MPH15118	WMU1.56/11.88	12	1-9/16	11-7/8	7	2	16d duplex	2	10d x 1-1/2	2585	2620	2645	
1-1/2 x 14	MPH1514	WMU1.56/14	12	1-9/16	14	7	2	16d duplex	2	10d x 1-1/2	2585	2620	2645	
1-3/4 x 9-1/2	MPH1795	WMU1.81/9.5	12	1-13/16	9-1/2	7	2	16d duplex	2	10d x 1-1/2	2975	3010	3035	
1-3/4 x 11-7/8	MPH17118	WMU1.81/11.88	12	1-13/16	11-7/8	7	2	16d duplex	2	10d x 1-1/2	2975	3010	3035	
1-3/4 x 14	MPH1714	WMU1.81/14	12	1-13/16	14	7	2	16d duplex	2	10d x 1-1/2	2975	3010	3035	
1-3/4 x 16	MPH1716	WMU1.81/16	12	1-13/16	16	7	2	16d duplex	2	10d x 1-1/2	2975	3010	3035	

1) Masonry compressive strength shall be minimum 1500 psi.

2) **NAILS:** 10d x 1-1/2 nails are 0.148" dia. x 1-1/2" long, 10d nails are 0.148" dia. x 3" long, 16d duplex nails are 0.162" dia. x 3-1/2" long, double headed nails and shall be installed in grouted cells in accordance to manufacturer's installation specifications.

Beam/ Joist Size	MiTek USP Stock No.	Ref. No.	Steel Gauge	Dimensions (in)			Fastener Schedule <sup>2</sup>				DF/SP Allowable Loads (Lbs.) <sup>1</sup>			Code Ref.
				W	H	L	Block		Joist		Floor	Roof		
							Qty	Type	Qty	Type		100%	115%	
				Engineered Lumber Sizes										
2-5/16 x 9-1/2	MPH2395	WMU2.37/9.5	12	2-3/8	9-1/2	7	2	16d duplex	2	10d x 1-1/2	3855	3890	3915	IBC, FL, LA
2-5/16 x 11-7/8	MPH23118	WMU2.37/11.88	12	2-3/8	11-7/8	7	2	16d duplex	2	10d x 1-1/2	3855	3890	3915	
2-5/16 x 14	MPH2314	WMU2.37/14	12	2-3/8	14	7	2	16d duplex	2	10d x 1-1/2	3855	3890	3915	
2-5/16 x 16	MPH2316	WMU2.37/16	12	2-3/8	16	7	2	16d duplex	2	10d x 1-1/2	3855	3890	3915	
2-5/16 x 18	MPH2318	WMU2.37/18	12	2-3/8	18	7	2	16d duplex	2	10d x 1-1/2	3855	3890	3915	
2-5/16 x 20	MPH2320	WMU2.37/20	12	2-3/8	20	7	2	16d duplex	2	10d x 1-1/2	3855	3890	3915	
2-1/2 x 9-1/4	MPH25925	WMU2.56/9.25	12	2-1/2	9-1/4	7	2	16d duplex	2	10d x 1-1/2	4145	4180	4205	
2-1/2 x 9-1/2	MPH2595	WMU2.56/9.5	12	2-1/2	9-1/2	7	2	16d duplex	2	10d x 1-1/2	4145	4180	4205	
2-1/2 x 11-1/4	MPH25112	WMU2.56/11.25	12	2-1/2	11-1/4	7	2	16d duplex	2	10d x 1-1/2	4145	4180	4205	
2-1/2 x 11-7/8	MPH25118	WMU2.56/11.88	12	2-1/2	11-7/8	7	2	16d duplex	2	10d x 1-1/2	4145	4180	4205	
2-1/2 x 14	MPH2514	WMU2.56/14	12	2-1/2	14	7	2	16d duplex	2	10d x 1-1/2	4145	4180	4205	
2-1/2 x 16	MPH2516	WMU2.56/16	12	2-1/2	16	7	2	16d duplex	2	10d x 1-1/2	4145	4180	4205	
2-1/2 x 18	MPH2518	WMU2.56/18	12	2-1/2	18	7	2	16d duplex	2	10d x 1-1/2	4145	4180	4205	
2-1/2 x 20	MPH2520	WMU2.56/20	12	2-1/2	20	7	2	16d duplex	2	10d x 1-1/2	4145	4180	4205	
2-1/2 x 22	MPH2522	WMU2.56/22	12	2-1/2	22	7	2	16d duplex	2	10d x 1-1/2	4145	4180	4205	
2-1/2 x 24	MPH2524	WMU2.56/24	12	2-1/2	24	7	2	16d duplex	2	10d x 1-1/2	4145	4180	4205	
2-1/2 x 26	MPH2526	WMU2.56/26	12	2-1/2	26	7	2	16d duplex	2	10d x 1-1/2	4145	4180	4205	
3 x 9-1/4	MPH210-2	WMU3.12/9.25	12	3-1/8	9-1/4	7	2	16d duplex	2	10d	4280	4280	4280	
3 x 9-1/2	MPH1595-2	WMU3.12/9.5	12	3-1/8	9-1/2	7	2	16d duplex	2	10d	4280	4280	4280	
3 x 11-1/4	MPH15112-2	WMU3.12/11.25	12	3-1/8	11-1/4	7	2	16d duplex	2	10d	4280	4280	4280	
3 x 11-7/8	MPH15118-2	WMU3.12/11.88	12	3-1/8	11-7/8	7	2	16d duplex	2	10d	4280	4280	4280	
3-1/2 x 12	MPH3512	WMU3.62/12	12	3-1/2	12	7	2	16d duplex	2	10d	4280	4280	4280	
3-1/2 x 14	MPH3514	WMU3.62/14	12	3-1/2	14	7	2	16d duplex	2	10d	4280	4280	4280	
3-1/2 x 16	MPH3516	WMU3.62/16	12	3-1/2	16	7	2	16d duplex	2	10d	4280	4280	4280	
3-1/2 x 18	MPH3518	WMU3.62/18	12	3-1/2	18	7	2	16d duplex	2	10d	4280	4280	4280	
3-1/2 x 20	MPH3520	WMU3.62/20	12	3-1/2	20	7	2	16d duplex	2	10d	4280	4280	4280	
3-1/2 x 9-1/4	MPH410	WMU3.56/9.25	12	3-9/16	9-1/4	7	2	16d duplex	2	10d	4280	4280	4280	
3-1/2 x 11-1/4	MPH412	WMU3.56/11.25	12	3-9/16	11-1/4	7	2	16d duplex	2	10d	4280	4280	4280	
3-1/2 x 9-1/2	MPH1795-2	WMU3.56/9.5	12	3-5/8	9-1/2	7	2	16d duplex	2	10d	4280	4280	4280	
3-1/2 x 11-7/8	MPH17118-2	WMU3.56/11.88	12	3-5/8	11-7/8	7	2	16d duplex	2	10d	4280	4280	4280	
4-5/8 x 11-7/8	MPH23118-2	WMU4.75/11.88	12	4-5/8	11-7/8	7	2	16d duplex	2	10d	4280	4280	4280	
4-5/8 x 14	MPH2314-2	WMU4.75/14	12	4-5/8	14	7	2	16d duplex	2	10d	4280	4280	4280	
4-5/8 x 16	MPH2316-2	WMU4.75/16	12	4-5/8	16	7	2	16d duplex	2	10d	4280	4280	4280	
4-5/8 x 18	MPH2318-2	WMU4.75/18	12	4-5/8	18	7	2	16d duplex	2	10d	4280	4280	4280	
4-5/8 x 20	MPH2320-2	WMU4.75/20	12	4-5/8	20	7	2	16d duplex	2	10d	4280	4280	4280	
5-1/4 x 9-1/2	MPH5595	WMU5.50/9.5	12	5-5/8	9-1/2	7	2	16d duplex	2	10d	4280	4280	4280	
5-1/4 x 11-7/8	MPH55118	WMU5.50/11.88	12	5-5/8	11-7/8	7	2	16d duplex	2	10d	4280	4280	4280	
7 x 9-1/2	MPH3595-2	WMU7.12/9.5	12	7-1/8	9-1/2	8	2	16d duplex	2	10d	4280	4280	4280	
7 x 11-1/4	MPH35112-2	WMU7.12/11.25	12	7-1/8	11-1/4	8	2	16d duplex	2	10d	4280	4280	4280	
7 x 11-7/8	MPH35118-2	WMU7.12/11.88	12	7-1/8	11-7/8	8	2	16d duplex	2	10d	4280	4280	4280	
7 x 14	MPH3514-2	WMU7.12/14	12	7-1/8	14	8	2	16d duplex	2	10d	4280	4280	4280	
7 x 16	MPH3516-2	WMU7.12/16	12	7-1/8	16	8	2	16d duplex	2	10d	4280	4280	4280	
7 x 18	MPH3518-2	WMU7.12/18	12	7-1/8	18	8	2	16d duplex	2	10d	4280	4280	4280	
Glulam Sizes														
3-1/8 x glulam	MPH325	WMU3.25X	12	3-1/4	specify	7	2	16d duplex	2	10d	4280	4280	4280	IBC, FL, LA
5-1/8 x glulam	MPH525	WMU5.25X	12	5-1/4	specify	7	2	16d duplex	2	10d	4280	4280	4280	

1) Masonry compressive strength shall be minimum 1500 psi.

2) **NAILS:** 10d x 1-1/2 nails are 0.148" dia. x 1-1/2" long, 10d nails are 0.148" dia. x 3" long, 16d duplex nails are 0.162" dia. x 3-1/2" long, double headed nails and shall be installed in grouted cells in accordance to manufacturer's installation specifications.

**Specialty Options Chart – Refer to Specialty Options pages 283, 285-286 for additional details.**

Option	Skewed <sup>1,3</sup>	Sloped Seat <sup>2</sup>	Sloped / Skewed <sup>1,2,3</sup>	Top Flange Offset	
Range	1° to 60°	1° to 45°	See Sloped Seat and Skewed	--	
Allowable Loads	100% of table load	100% of table load	100% of table load	Hanger Width 3-1/2" or less 3-9/16" to 5-1/2" 5-9/16" to 7-1/2"	% of table load: 60% 75% 85%
Ordering	Add SK, angle required, right (R) or left (L), and square cut (SQ) or bevel cut (BV) to product number. Ex. MPH210_SK45R_SQ	Add SL, slope required, and up (U) or down (D), to product number. Ex. MPH210_SL30D	See Sloped Seat and Skewed. Ex. MPH210_SK45R_SQ_SL30D	Add OS, and right (R) or left (L), to product number. Ex. MPH210_OLS	

- Skewed hangers with skews greater than 15° may have all joist nailing on outside flange.
- Sloped or sloped / skewed hangers with slopes greater than 15° may have additional joist nails.
- For skewed hangers, the required cut type (square or bevel) of joist member may vary based on skew angle and width of hanger. Some square cut hangers will require custom pricing due to welded back plate.

A versatile solution for hanging beams from masonry walls. Face mount design allows hanger to be used with beam heights from 16" to 24". Available in a variety of widths for solid sawn, glulam, or engineered lumber beams.

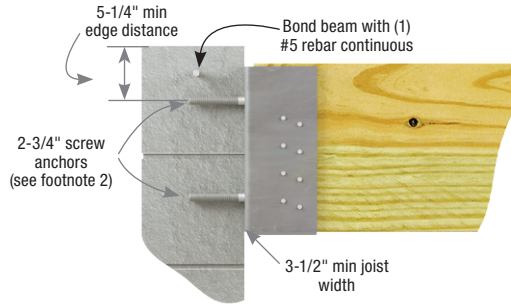
**Materials:** 3 gauge

**Finish:** Primer

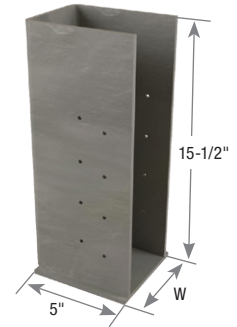
**Codes:** See page 12 for Code Reference Chart

**Installation:**

- Use all specified fasteners. See Product Notes, page 20.
- Fully grouted and reinforced concrete block or cast-in-place concrete with a minimum of (1) #5 rebar continuous to footing with standard hook at bolt locations.
- Minimum joist width is 3-1/2".



**Typical UMH installation**



**UMH**

MiTek USP Stock No.	Ref. No.	Steel Gauge	W (in)	Fastener Schedule				DF/SP Allowable Loads (Lbs.)								Code Ref.
				Header <sup>2</sup>		Joist <sup>3</sup>		Masonry - 2,500 psi				Cast in Place Concrete - 3,000 psi				
				Qty	Screw Anchor	Qty	Type	Floor 100%	Roof 115%	125%	Uplift <sup>1</sup> 160%	Floor 100%	Roof 115%	125%	Uplift <sup>1</sup> 160%	
UMH358	MBHU3.56/16KT, MBHU3.56/18KT	3	3-5/8	2	3/4	16	16d	3550	3550	3550	3550	6380	6380	6380	4815	FL
UMH458	--	3	4-5/8	2	3/4	16	16d	3550	3550	3550	3550	6380	6380	6380	4815	
UMH538	--	3	5-3/8	2	3/4	16	16d	3550	3550	3550	3550	6380	6380	6380	4815	
UMH558	MBHU5.50/16KT, MBHU5.50/18KT	3	5-5/8	2	3/4	16	16d	3550	3550	3550	3550	6380	6380	6380	4815	
UMH718	--	3	7-1/8	2	3/4	16	16d	3550	3550	3550	3550	6380	6380	6380	4815	

1) Uplift loads have been increased 60% for wind or seismic loads; no further increase shall be permitted.  
 2) Fasten UMH hanger to concrete structure with (2) 3/4" dia. DeWalt Screw-Bolt™+ screw anchors or equal with 5" minimum embedment. Screw anchors shall be installed in masonry with grouted cells in accordance with manufacturer's installation specifications.  
 3) **NAILS:** 16d nails are 0.162" dia. x 3-1/2" long.

**NFM** Narrow Flange Masonry Hangers

**NFM** – Standard design.

**NFM\_U** – High uplift design.

**Materials:** Top Flange – 3/8" steel; U-strap – 7 gauge

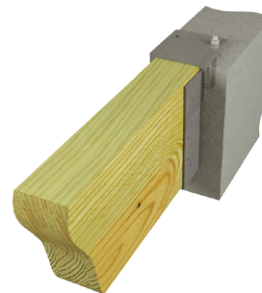
**Finish:** Primer

**Options:** See Specialty Options Chart on page 180.

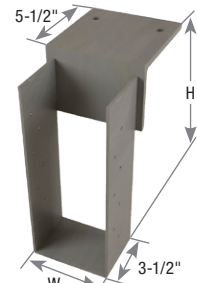
**Codes:** See page 12 for Code Reference Chart

**Installation:**

- Use all specified fasteners. See Product Notes, page 20.
- Designed for both concrete walls and grout-filled reinforced CMU walls.



**Typical NFM installation**



**NFM3**



**Typical NFM\_U installation**



**NFM3X12U**

MiTek USP Stock No.	Ref. No.	Steel Gauge		Dimensions (in)		Fastener Schedule				DF/SP Allowable Loads (Lbs.) <sup>1,2</sup>				Code Ref.
		Top Flange	U-Strap	W	H	Header <sup>3,4,5</sup>		Joist <sup>6</sup>		Floor 100%	Roof 115%	Roof 125%	Uplift 160%	
						Qty	Type	Qty	Type					
NFM3X8	--	3/8	7	3-1/8	7-1/4	1	1/2" J-Bolt	10	10d	6720	6720	6720	1415	FL
NFM3X10	--	3/8	7	3-1/8	9-1/4	1	1/2" J-Bolt	12	10d	6720	6720	6720	1415	
NFM3X10U	MBHA3.12/9.25	3/8	7	3-1/8	9-1/4	1	1/2" J-Bolt	5	1/2" Bolt	7130	7130	7130	2580	
NFM3X12	--	3/8	7	3-1/8	11-1/4	1	1/2" J-Bolt	14	10d	6720	6720	6720	1415	
NFM3X12U	MBHA3.12/11.25	3/8	7	3-1/8	11-1/4	1	1/2" J-Bolt	5	1/2" Bolt	7130	7130	7130	2580	
NFM3	--	3/8	7	3-3/8	11-3/4	1	1/2" J-Bolt	14	10d	7510	7510	7510	1415	
NFM35X8	--	3/8	7	3-5/8	7-1/4	1	1/2" J-Bolt	10	10d	7510	7510	7510	1415	
NFM35X8U	MBHA3.56/7.25	3/8	7	3-5/8	7-1/4	1	1/2" J-Bolt	3	1/2" Bolt	7130	7130	7130	2580	
NFM35X10	--	3/8	7	3-5/8	9-1/4	1	1/2" J-Bolt	12	10d	7510	7510	7510	1415	
NFM35X10U	MBHA3.56/9.25	3/8	7	3-5/8	9-1/4	1	1/2" J-Bolt	5	1/2" Bolt	7130	7130	7130	2580	
NFM35X12	--	3/8	7	3-5/8	11-1/4	1	1/2" J-Bolt	14	10d	7510	7510	7510	1415	
NFM35X12U	MBHA3.56/11.25	3/8	7	3-5/8	11-1/4	1	1/2" J-Bolt	5	1/2" Bolt	7130	7130	7130	2580	
NFM35X1178	--	3/8	7	3-5/8	11-7/8	1	1/2" J-Bolt	14	10d	7510	7510	7510	1415	
NFM35X1178U	MBHA3.56/11.88	3/8	7	3-5/8	11-7/8	1	1/2" J-Bolt	5	1/2" Bolt	7130	7130	7130	2580	
NFM35X14	--	3/8	7	3-5/8	14	1	1/2" J-Bolt	14	10d	7510	7510	7510	1415	--
NFM35X14U	MBHA3.56/14	3/8	7	3-5/8	14	1	1/2" J-Bolt	5	1/2" Bolt	7130	7130	7130	2580	FL
NFM35X16	--	3/8	7	3-5/8	16	1	1/2" J-Bolt	14	10d	7510	7510	7510	1415	
NFM35X16U	MBHA3.56/16	3/8	7	3-5/8	16	1	1/2" J-Bolt	5	1/2" Bolt	7130	7130	7130	2580	
NFM35X18	--	3/8	7	3-5/8	18	1	1/2" J-Bolt	14	10d	7510	7510	7510	1415	
NFM35X18U	MBHA3.56/18	3/8	7	3-5/8	18	1	1/2" J-Bolt	5	1/2" Bolt	7130	7130	7130	2580	
NFM6X8U	MBHA5.50/7.25	3/8	7	5-5/8	7-1/4	1	1/2" J-Bolt	3	1/2" Bolt	10310	10310	10310	2580	
NFM6X10U	MBHA5.50/9.25	3/8	7	5-5/8	9-1/4	1	1/2" J-Bolt	5	1/2" Bolt	10310	10310	10310	2580	
NFM6X12U	MBHA5.50/11.25	3/8	7	5-5/8	11-1/4	1	1/2" J-Bolt	5	1/2" Bolt	10310	10310	10310	2580	
NFM6X1178	--	3/8	7	5-5/8	11-7/8	1	1/2" J-Bolt	14	10d	7510	7510	7510	1415	
NFM6X1178U	MBHA5.50/11.88	3/8	7	5-5/8	11-7/8	1	1/2" J-Bolt	5	1/2" Bolt	10310	10310	10310	2580	
NFM6X14U	MBHA5.50/14	3/8	7	5-5/8	14	1	1/2" J-Bolt	5	1/2" Bolt	10310	10310	10310	2580	
NFM6X16	--	3/8	7	5-5/8	16	1	1/2" J-Bolt	14	10d	7510	7510	7510	1415	
NFM6X16U	MBHA5.50/16	3/8	7	5-5/8	16	1	1/2" J-Bolt	5	1/2" Bolt	10310	10310	10310	2580	
NFM6X18	--	3/8	7	5-5/8	18	1	1/2" J-Bolt	14	10d	7510	7510	7510	1415	
NFM6X18U	MBHA5.50/18	3/8	7	5-5/8	18	1	1/2" J-Bolt	5	1/2" Bolt	10310	10310	10310	2580	

1) Allowable loads are based on 2,500 psi concrete or masonry.

2) Design loads are governed by test ultimate loads with a safety factor of three.

3) J-Bolt shall be cast-in-place and have a minimum 6" embedment and not less than 4" from the edge of concrete.

4) In addition to the J-Bolt, "U" models also require a 3/4" dia. ITW Ramset/Redhead Dyna Bolt sleeve anchor or equal with minimum 5" embedment depth installed in the face. Bolt shall be installed in accordance with installation specifications provided by ITW Ramset.

5) Bolts shall conform to ASTM A 307 or better.

6) **NAILS:** 10d nails are 0.148" dia. x 3" long

### Specialty Options Chart

Refer to Specialty Options pages 283, 285-286 for additional details.

Option	MiTek USP Series	Skewed <sup>1,2</sup>
Range	NFM / NFMU	1° to 45°
Allowable Loads	NFM / NFMU	100% of table load
Ordering	NFM	Add SK, angle required, right ( <i>R</i> ) or left ( <i>L</i> ), and square cut ( <i>SQ</i> ) or bevel cut ( <i>BV</i> ) to product number. Ex. NFM3_SK45R_BV
	NFMU	Add SK, angle required, right ( <i>R</i> ) or left ( <i>L</i> ), and square cut ( <i>SQ</i> ) to product number. Ex. NFM35X8U_SK45R_SQ

1) Skewed hangers with skews greater than 15° may have all joist nailing on outside flange.

2) For skewed hangers, the required cut type (square or bevel) of joist member may vary based on skew angle and width of hanger. Some square cut hangers will require custom pricing due to welded back plate.

EWP Hanger Selector Guide

Hanger Type	MiTek USP Series	Steel Gauge	Supporting Member							Supported Member					Allowable Loads (Lbs.) Range		MiTek Series Catalog Page Reference			
			Beam/Joist/Rafter (rect shapes)	I-Joist	Truss (2x)	Floor Truss 4x	Nailer	Glulam	Wall	Post	Rim Joist	Beam/Joist/Rafter (rect shapes)	I-Joist	Truss (2x)	Floor Truss 4x	Glulam		Stringer	Header Material	
																			LVL 100%	DF/SP 100%
Face Mount	THF	16	*	*			*				*	*	*	*			1,890	1,890	186, 191	
		12	*	*			*				*	*	*	*			2,660 - 3,190	2,660 - 3,190		
	THFI	18	*	*			*				*	*	*	*			960 - 1,680	960 - 1,680	184, 190	
	IHFL	18	*	*	*		*			*			*				960 - 1,920	960 - 1,920	185,	
	IHF	16	*	*	*		*			*			*				1,000 - 4,410	1,000 - 4,410	189-191	
	HUS	16	*	*	*		*			*			*	*	*	*	5,510	5,510	187, 192	
	HD	14	*	*	*		*			*	*	*	*	*	*	*	1,850 - 5,195	1,625 - 4,270	186, 191-194	
	HDQIF	14	*	*	*		*		*	*	*	*	*	*	*	*	3,340 - 5,605	3,340 - 5,605	187, 192-194	
	THD	14	*	*	*		*				*	*	*	*	*	*	5,850 - 7,045	5,850 - 7,045	188,	
		12	*	*	*		*				*	*	*	*	*	*	6,535 - 8,415	6,535 - 8,415	193-194	
THDH	12	*	*	*		*				*	*	*	*	*	*	8,990 - 12,510	8,990 - 12,510	188, 192-194		
Top Mount	TFL	18	*	*	*	*	*			*	*	*	*	*	*	1,585	1,585	195, 199-200		
	THO	18	*	*	*	*	*				*	*	*	*	*	1,235 - 5,660	1,235 - 5,000	195, 199-204		
		16	*	*	*	*	*				*	*	*	*	*					
	12	*	*	*	*	*					*	*	*	*	*					
	TFI	16	*	*	*	*	*	*			*	*	*	*	*	2,715 - 2,820	2,715 - 2,820	195, 199-200, 202-203		
	BPH	12	*	*	*	*	*	*	*		*	*	*	*	*	2,830 - 3,100	2,825 - 3,100	196, 199, 201-207		
	HBPH	10	*	*	*	*	*	*	*	*		*	*	*	*	6,235 - 6,310	6,235 - 6,310	196, 201-207		
	PHM	7 - Top Flange; 10 - Stirrup	*	*	*	*	*	*			*	*	*	*	*	3,265 - 3,390	3,060 - 3,390	198-207		
PHXU	7	*	*	*	*	*	*			*	*	*	*	*	4,350 - 5,910	4,350 - 5,910	198-199, 201-203, 205-207			
HLBH	7	*	*	*	*	*	*			*	*	*	*	*	10,045	10,045	197, 201-203, 205-207			
Glulam	GHF	12	*	*	*	*	*	*			*	*	*	*	*	2,190 - 6,570	2,190 - 6,570	211-212		
		7	*	*	*	*	*	*			*	*	*	*	*	6,500 - 12,000	6,500 - 12,000			
	HGU	7	*	*	*	*	*	*			*	*	*	*	*	14,705	14,705	210		
	KLEG <sup>2</sup>	7	*	*	*	*	*	*			*	*	*	*	*	11,940	11,940	213		
	KMEG <sup>2</sup>	7	*	*	*	*	*	*			*	*	*	*	*	12,635	12,635	213		
	KEG <sup>2</sup>	1/4" - Top Flange; 7 - Stirrup	*	*	*	*	*	*			*	*	*	*	*	17,615 - 21,545	17,615 - 21,545	213		
	KHGB	7	*	*	*	*	*	*			*	*	*	*	*	5,835 - 5,960	5,835 - 5,960	214		
	KGB	7	*	*	*	*	*	*			*	*	*	*	*	7,000	7,000	214		
	KHGB	7	*	*	*	*	*	*			*	*	*	*	*	7,000	7,000	214		
	KGLT	3 - Top Flange; 7 - Stirrup	*	*	*	*	*	*			*	*	*	*	*	9,920	9,920	215		
	KHGLT	3 - Top Flange; 7 - Stirrup	*	*	*	*	*	*			*	*	*	*	*	13,240 - 13,400	13,240 - 13,400	215		
	KGLS	3 - Top Flange; 7 - Stirrup	*	*	*	*	*	*			*	*	*	*	*	10,275 - 20,425	10,275 - 20,425	218		
	KHGLS	3 - Top Flange; 7 - Stirrup	*	*	*	*	*	*			*	*	*	*	*	20,685 - 20,985	20,685 - 20,985	218		
	KGLST	3 - Top Flange; 7 - Stirrup	*	*	*	*	*	*			*	*	*	*	*	12,900 - 26,095	12,900 - 26,095	218		
	KHGLST	3 - Top Flange; 7 - Stirrup	*	*	*	*	*	*			*	*	*	*	*	19,250 - 26,585	19,250 - 26,585	218		
	KHC	7	*	*	*	*	*	*			*	*	*	*	*	10,505 - 44,100	10,505 - 44,100	216-217		
3		*	*	*	*	*	*			*	*	*	*	*	22,040 - 54,180	22,040 - 54,180				
KHCST <sup>1</sup>	7	*	*	*	*	*	*			*	*	*	*	*	9,950 - 14,500	9,950 - 14,500	217			
	3	*	*	*	*	*	*			*	*	*	*	*	20,145	20,145				
LGU	10	*	*	*	*	*	*			*	*	*	*	*	7,135	7,135	210			
MGU	10	*	*	*	*	*	*			*	*	*	*	*	9,515	9,515	210			
Slope / Skew	LSSH	18	*	*	*	*	*			*	*	*	*	*	685 - 1,180	685 - 1,180	209			
		16	*	*	*	*	*			*	*	*	*	*	1,825 - 2,590	1,825 - 2,590				

Copyright © 2019 MiTek Industries, Inc. All Rights Reserved

1) KHCST allowable loads are based on 160% load duration.  
 2) KEG, KLEG, KMEG hangers assume allowable loads with top flange.  
 3) When an I-Joist is used as a header, designer must evaluate if a web stiffener or backer block is required.  
 • Represents common applications and product configurations. Consult MiTek for additional applications and/or optional product configurations.  
 New products or updated product information are designated in **blue font**.

**Sloped I-Joists**

Use sloped seat hangers and beveled web stiffeners whenever the slope exceeds the following: 1/2:12 for seat bearing lengths of 2-1/2" or less; 3/8:12 for bearing lengths between 2-1/2" and 3-1/2"; and 1/4:12 for bearing lengths in excess of 3-1/2".

**Multiple I-Joist Plies**

Fasten together multiple plies of wood I-Joists, in accordance with the manufacturer's installation guidelines, such that the joists act as a single unit.

**I-Joist Rotation**

It may be necessary to install straps, blocking, or sheathing to restrain torsional rotation of a supporting wood I-Joist when using top mount I-Joist hangers.

**Fasteners**

Install only the specified nails. The flanges of wood I-Joists may split if larger diameter nails or longer nails are installed. Do not install nails larger than 16d common wire nails (0.162" diameter) into the web stiffeners in the wood I-Joist.

**Backer Blocks**

Pattern the nails used to install backer blocks or web stiffeners in wood I-Joists to avoid splitting the block. The nail pattern should be sufficiently spaced to avoid the same grain line, particularly with solid sawn backer blocks. Backer blocks must be installed on wood I-Joist acting as the header, or supporting member. Install in accordance with the I-Joist manufacturer's installation guidelines. The nails used to install hangers mounted to an I-Joist header must penetrate through the web and into the backer block on the opposite side.

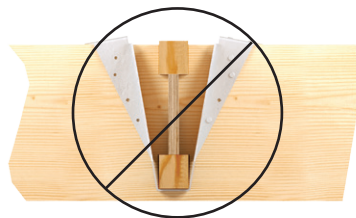
**Top Flange Hangers**

The thickness of the hanger metal and nail heads on top mount hangers must be evaluated for the effect on subsequent sheathing. Ensure that the top mount hanger is installed so the flanges of the hanger are not over-spread which tends to elevate the supported I-Joist causing uneven

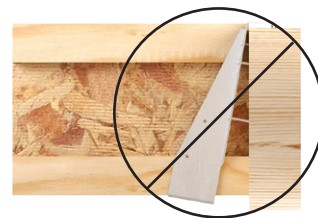
floor surfaces and squeaking. Similarly, ensure that the hanger is installed plumb such that the face flanges of the hanger are mounted firmly against the wide-face surface of the header.



Flush framing



! Hanger over-spread



! Hanger not plumb

**Correct Slant Nail Installation**

Always secure wood I-Joist using 10d x 1-1/2" nail driven at a 30° to 45° angle and firmly seated

**Common Nailing Errors****! Wrong Angle**

When a nail is driven into the bottom flange of the wood I-Joist parallel to the glue lines, separation of veneers can occur which substantially reduces the design loads of the connection.

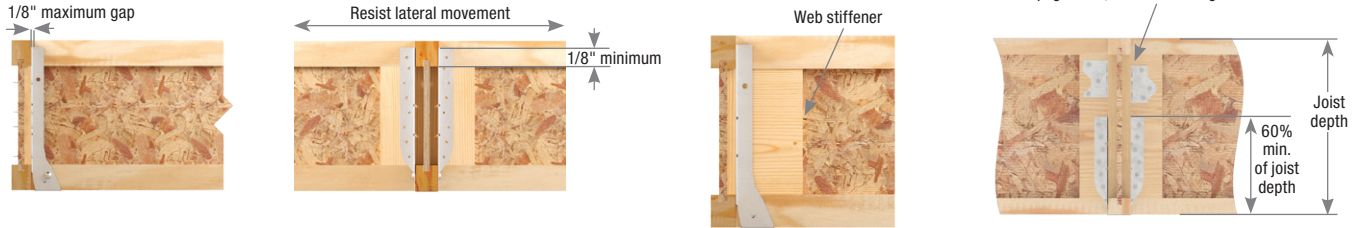
**! Nail Too Long**

When using nails longer than MiTek's recommended nails, bottom flange splitting may occur. Also, this can raise the wood I-Joist off the seat, resulting in uneven surfaces and squeaky floors along with reduced allowable loads.

Hangers for joists **without web stiffeners** must support the I-Joist's top flange and provide lateral resistance with no less than 1/8" contact.

be 60% of the joist height for stability during construction. If this cannot be accomplished, potential joist rotation must be resolved by other means.

MiTek recommends that hangers for joist **with web stiffeners** should



(Top flange support requirements can be verified in this section charts under Web stiffener Req'd. column.)

## Nailer Installations

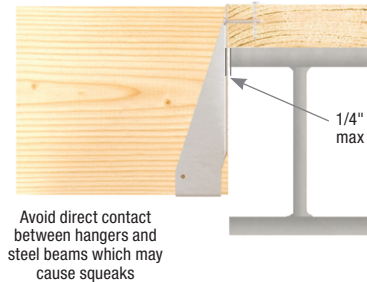
### Correct Hanger Attachment to Nailer

A nailer or sill plate is considered to be any wood member attached to a steel beam, concrete block wall, concrete stem wall, or other structure unsuitable for nailing, which is used as a nailing surface for top mount hangers to hold beams or joists.

### Nailer Sized Correctly

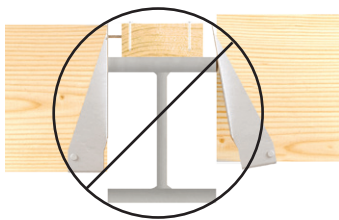
Top flange of hanger is fully supported and recommended nails have full penetration into nailer, resulting in a carried member hanging safely at the proper height.

The nailer must be sized to fit the support width as shown and be of sufficient thickness to satisfy recommended top flange nailing requirements. A design professional must specify nailer attachment to steel beams.



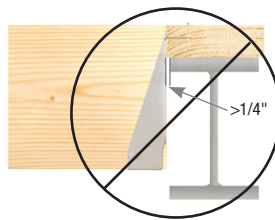
**Correct Attachment**

## Wrong Nailer Size Causes Component Failure



**Too Narrow**

Top flange not fully supported can cause nail breakout. Or, by fully supporting top flange, hanger is tilted back, causing lifting of carried member which results in uneven surfaces and squeaky floors.



**Too Wide**

Loading can cause cross grain breaking of nailer. The recommended nailer overhang is 1/4" maximum per side.



**Too Thin**

Top flange nailing cannot fully penetrate nailer, causing reduced allowable loads. Never use hangers which require multiple face nails since the allowable loads are dependent on all nail holes being used.

The THFI is a face mount hanger designed to attach EWP I-joist members to wood headers. The unique design of the THFI combines the installation ease of a top mount hanger with the installation flexibility of a face mount hanger. Because the side flanges extend to the top chord of the I-joist, web stiffeners are not required. The THFI hangers also feature strategically placed Seat Cleats® which lock the bottom flange of the I-joist to the hanger eliminating the need for joist nails to be installed.

The innovative top flange alignment tabs with the holding cleats assist the placing and alignment of the hanger prior to nailing by hanging onto the header with holding cleats biting into the wood. If the alignment tabs are not desired or a deeper height member is to be carried, the tabs can be easily bent out of the way. Alignment tabs do not contribute to the allowable design values of the THFI hangers.

**Materials:** 18 Gauge

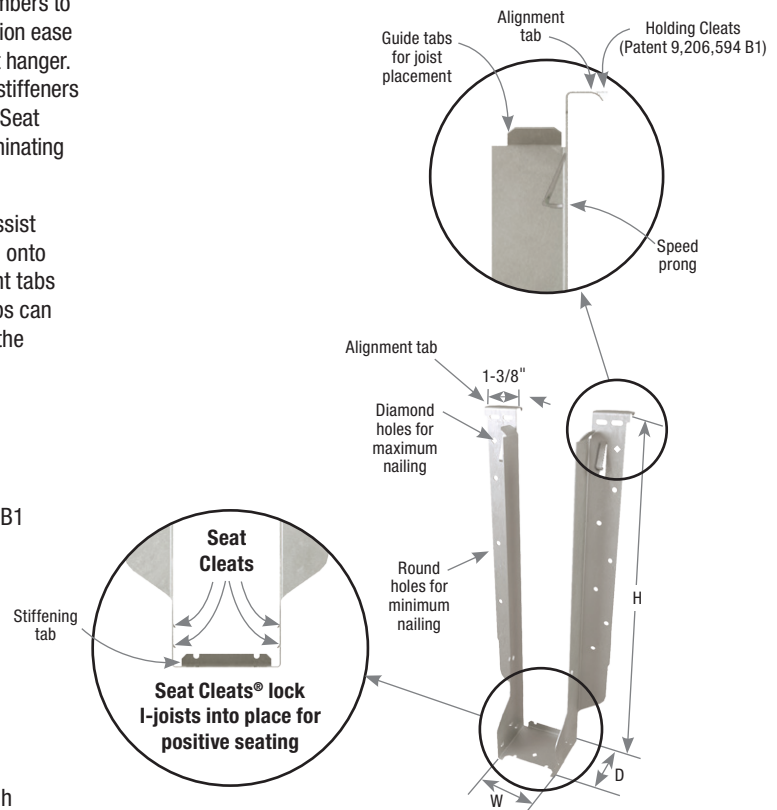
**Finish:** G90 galvanizing

**Codes:** See page 12 for Code Reference Chart

**Patents:** U.S. Patent No. 5,564,248 & U.S. Patent No. 9,206,594 B1

#### Installation:

- Use all specified fasteners.
- Alignment tabs are not structural and can be bent back or removed to assist hanger placement.
- Web stiffeners are not required for THFI hangers unless specified by the I-joist manufacturer. Web stiffeners are not required for lateral stability.
- For additional uplift capacity, install (2) 10d x 1-1/2" nails through diamond holes and into the joist member. (web stiffeners required)
- THFI2514 model has diamond holes in the header flange for MIN/MAX nailing option. For the MAX nailing option, install nails in both the round and diamond shaped header holes.



THFI2514



Typical THFI installation



IHFL (18GA) and IHF (16GA) series face mount hangers feature speed prongs for temporary placement and seat cleats to grab the bottom flange of the supported I-joist. Diamond holes in header and joist allow for optional Max nailing for customized fastening to match allowable load needed. Install nails in all fastener holes when the Max allowable load is needed while lighter load capacities can be achieved with a quick installation of round holes only, saving you time and money on the jobsite.

**Features:**

- Seat Cleats lock bottom chord of I-joist eliminating need for joist nails.
- Dimples with diamond nail holes for optional joist nailing when higher uplift loads are needed.
- Min/Max nailing provide flexible installation options.

**Materials:** IHFL – 18 gauge; IHF – 16 gauge

**Finish:** G90 galvanizing

**Options:** See Specialty Options chart.

**Codes:** See page 12 for Code Reference Chart

**Patents:** U.S. Patent No. #5,564,248

**Installation:**

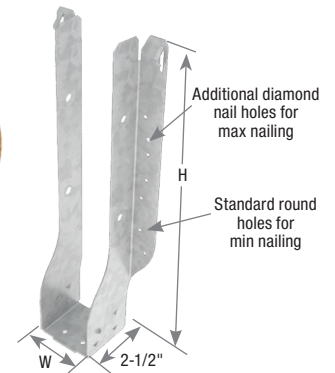
- Use all specified fasteners.
- Position I-joist into hangers and tap or push into place to fully seat joist and engage cleats.
- Web stiffeners are not required unless specified by the I-joist manufacturer.
- **Min Nailing** – Fill all round nail holes.
- **Max Nailing** – Fill all round and diamond holes.

**Uplift Capacity Options:**

- **IHFL (18GA)** – For additional uplift capacity, install (2) 10d (0.148") x 1-1/2" nails through diamond dimple holes into the bottom chord of I-joist member for a total uplift of 220 lbs.
- **IHF (16GA)**– Uplift capacity for hangers installed without joist nails is 65 lbs.



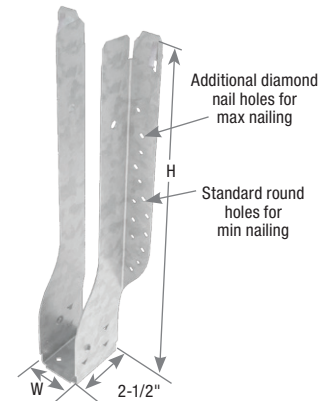
**Typical IHFL2514 min nailing installation**



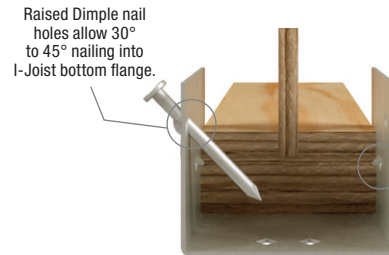
**IHFL2514**



**Typical IHF1714 max nailing installation**



**IHF1714**



Raised Dimple nail holes allow 30° to 45° nailing into I-Joist bottom flange.

Seat Cleat® helps lock I-Joist into place for positive seating and nailing ease.

**Specialty Options Chart** – refer to Specialty Options pages 283-284 for additional details.

Option	Skewed <sup>1,3,4,5</sup>	Sloped Seat <sup>2,3,4</sup>	Sloped / Skewed <sup>1,2,3,4</sup>	Inverted Flange <sup>4</sup>
<b>Range</b>	1° to 67-1/2° when width is 1-3/4" or less. 1° to 50° on all others.	1° to 45°	See Sloped Seat and Skewed	Not available in widths less than 2-1/4"
<b>Allowable Loads</b>	100% of table load. 75% of uplift load on skews greater than 15°.	100% of table load	80% of table load. 75% of uplift load on skews greater than 15°.	100% of table load. 65% of table load when nailing into the support members end grain.
<b>Ordering</b>	Add SK, angle required, right (R) or left (L), and square cut (SQ) or bevel cut (BV) to product number. Example: IHF23925_SK45R_BV	Add SL, slope required, and up (U) or down (D), to product number. Example: IHF23925_SL30D	See Sloped Seat and Skewed Example: IHF23925_SK45R_BV_SL30D	Add IF, to product number. Example: IHF23925_IF

1) Skewed hangers with skews greater than 15° may have all joist nailing on outside flange.  
 2) Sloped or sloped / skewed hangers with slopes greater than 15° may have additional joist nails.  
 3) For skewed hangers, the required cut type (square or bevel) of joist member may vary based on skew angle and width of hanger. Some square cut hangers will require custom pricing due to welded back plate.  
 4) Modifications to IHFL or IHF hangers do not feature seat cleats or optional nailing.  
 5) Skewed hangers may require web stiffeners to be installed in order to facilitate joist nail installations.

# THF Face Mount I-Joist Hangers



Designed to provide lateral support for the top chords of I-Joists in depths up to 16".

**Materials:** See EWP Face Mount Hangers charts, pages 191.

**Finish:** G90 galvanizing

**Options:** See Specialty Options chart.

**Codes:** See page 12 for Code Reference Chart

**Installation:**

- Use all specified fasteners. See Product Notes, page 20.



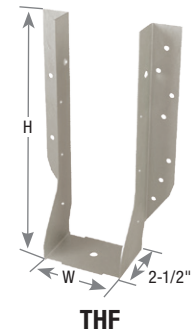
**Typical THF I-Joist to joist installation**



**Typical THF double I-Joist to LVL installation**

**Specialty Options Chart** – refer to Specialty Options pages 283-284 for additional details.

Option	Skewed <sup>1,3</sup>	Sloped Seat <sup>2,3</sup>	Sloped / Skewed <sup>1,2,3</sup>	Inverted Flange
<b>Range</b>	1° to 50°	1° to 45°	See Sloped Seat and Skewed	Not available in widths less than 2-1/4"
<b>Allowable Loads</b>	100% of table load. 75% of uplift load on skews greater than 15°.	100% of table load	80% of table load. 75% of uplift load on skews greater than 15°.	100% of table load. 65% of table load when nailing into the support members end grain.
<b>Ordering</b>	Add <i>SK</i> , angle required, right ( <i>R</i> ) or left ( <i>L</i> ), and square cut ( <i>SQ</i> ) or bevel cut ( <i>BV</i> ) to product number. Example: THF23118-2_SK45R_BV	Add <i>SL</i> , slope required, and up ( <i>U</i> ) or down ( <i>D</i> ), to product number. Example: THF23118-2_SL30D	See Sloped Seat and Skewed Example: THF23118-2_SK45R_BV_SL30D	Add <i>IF</i> , to product number. Example: THF23118-2_IF



- 1) Skewed hangers with skews greater than 15° may have all joist nailing on outside flange.
- 2) Sloped or sloped / skewed hangers with slopes greater than 15° may have additional joist nails.
- 3) For skewed hangers, the required cut type (square or bevel) of joist member may vary based on skew angle and width of hanger. Some square cut hangers will require custom pricing due to welded back plate.

# HD Face Mount Hangers

Designed to support LVL, LSL, and PSL beams and headers in medium load conditions.

**Materials:** See EWP Face Mount Hangers charts, pages 192-194.

**Finish:** G90 galvanizing

**Options:** See Specialty Options chart.

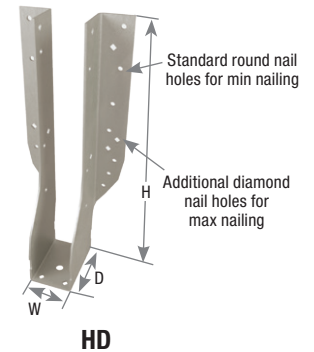
**Codes:** See page 12 for Code Reference Chart

**Installation:**

- Use all specified fasteners. See Product Notes, page 20.
- **Min** – Fill all round nail holes.
- **Max** – Fill all round and diamond nail holes.



**Typical HD installation**



**Specialty Options Chart** – refer to Specialty Options pages 283-284 for additional details.

Option	Skewed <sup>1,3</sup>	Sloped Seat <sup>2,3</sup>	Sloped / Skewed <sup>1,2,3</sup>	Inverted Flange
<b>Range</b>	1° to 67-1/2° when width is 1-3/4" or less. 1° to 50° on all others.	1° to 45°	See Sloped Seat and Skewed	2-1/4" widths or greater (Widths < 2-1/4" may be available as a Custom, contact MiTek)
<b>Allowable Loads</b>	100% of table load. 75% of uplift load on skews greater than 15°.	100% of table load	80% of table load. 75% of uplift load on skews greater than 15°.	100% of table load. 65% of table load when nailing into the support members end grain.
<b>Ordering</b>	Add <i>SK</i> , angle required, right ( <i>R</i> ) or left ( <i>L</i> ), and square cut ( <i>SQ</i> ) or bevel cut ( <i>BV</i> ) to product number. Example: HD410_SK45R_SQ	Add <i>SL</i> , slope required, and up ( <i>U</i> ) or down ( <i>D</i> ), to product number. Example: HD410_SL30D	See Sloped Seat and Skewed Example: HD410_SK45R_SQ_SL30D	Add <i>IF</i> , to product number. Example: HD410_IF

- 1) Skewed hangers with skews greater than 15° may have all joist nailing on outside flange.
- 2) Sloped or sloped / skewed hangers with slopes greater than 15° may have additional joist nails.
- 3) For skewed hangers, the required cut type (square or bevel) of joist member may vary based on skew angle and width of hanger. Some square cut hangers will require custom pricing due to welded back plate.
- 4) HD option hangers may be manufactured as welded products to achieve listed loads. Welded products have a primer finish.

Inverted flange face mount hangers fasten to LVL, LSL and PSL beams and headers with WS Wood Screws.

**Materials:** See EWP Face Mount Hangers charts, pages 192-194.

**Finish:** G90 galvanizing

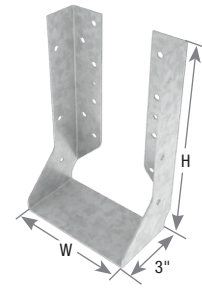
**Codes:** See page 12 for Code Reference Chart

**Installation:**

- Use all specified fasteners. See Product Notes, page 20.
- WS15 (1/4" dia. x 1-1/2" long) and WS3 (1/4" dia. x 3" long) Wood Screws are supplied with HDQIF hangers.



**Typical HDQIF  
inverted flange installation**



**HDQIF**

## HUS Face Mount Hangers

Designed for medium load conditions. Extended 3" deep seat provides enhanced truss bearing.

**Materials:** 16 gauge

**Finish:** G90 galvanizing

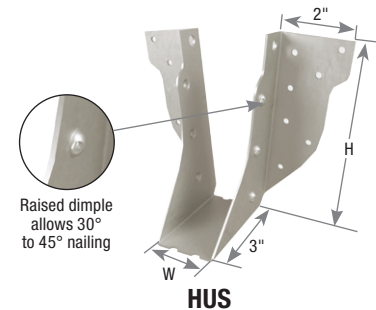
**Codes:** See page 12 for Code Reference Chart

**Installation:**

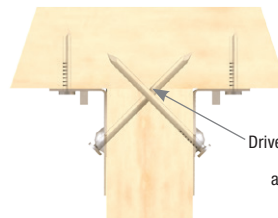
- Use all specified fasteners. See Product Notes, page 20.
- Joist nails must be driven at a 30° to 45° angle through the joist into the header to achieve listed loads. Slant/double shear nails must be used to achieve listed load values.



**Typical HUS  
installation**



**HUS**



**Typical HUS double  
shear installation**

Drive joist nails into header at 30° to 45° to achieve listed loads.

**THD** – Medium capacity hanger for LVL, LSL, and PSL beams.

**THDH** – Heavy capacity hanger for LVL, LSL, and PSL beams.

**Materials:** See EWP Face Mount Hangers charts, pages 192-194.

**Finish:** G90 galvanizing

**Options:** Rough/ Full sizes available for THD series. THD hangers with widths greater than 3" can have one flange inverted with no load reduction. Specify left (L) or (R) flange. See Specialty Options chart.

**Codes:** See page 12 for Code Reference Chart

**Installation:**

- Use all specified fasteners. See Product Notes, page 20.
- **THDH** – Drive joist nails into header at 30° to 45° to achieve listed loads.

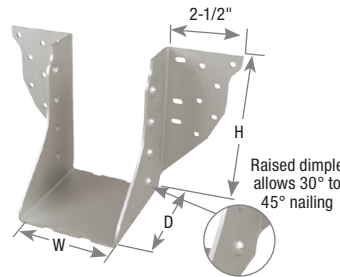


**Typical THDH installation**

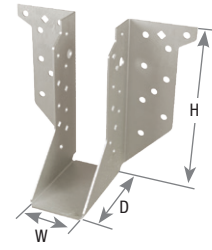


**Typical THD installation**

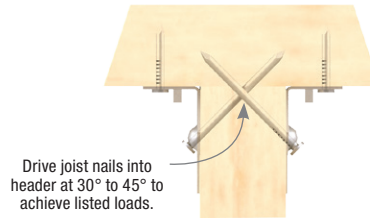
Some model designs may vary from illustration shown



**THDH26-2**

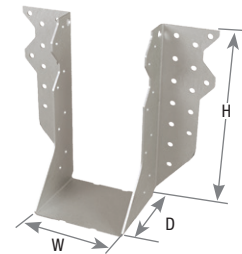


**THD single**



Drive joist nails into header at 30° to 45° to achieve listed loads.

**Typical THDH double shear installation**



**THD double or larger**

**Specialty Options Chart**

– refer to Specialty Options pages 283-284 for additional details.

Option	MiTek USP Series	Skewed <sup>1,3,4</sup>	Sloped Seat <sup>2</sup>	Sloped / Skewed <sup>1,2,3,4</sup>	Inverted Flange
Range	THD	1° to 45°	1° to 45°	See Sloped Seat and Skewed	Not available in widths less than 3". Widths greater can have one flange inverted.
	THDH				N/A
Allowable Loads	THD	85% of table load	65% of table load	65% of table load	100% of table load. 65% of table load when nailing into the support members end grain.
	THDH	85% of table load. 50% of table uplift load.	52% of table load	52% of table load. 50% of table uplift load.	N/A
Ordering	THD	Add <i>SK</i> , angle required, right ( <i>R</i> ) or left ( <i>L</i> ), and square cut ( <i>SQ</i> ) or bevel cut ( <i>BV</i> ) to product number. Ex. THDH410_SK45R_BV	Add <i>SL</i> , slope required, and up ( <i>U</i> ) or down ( <i>D</i> ), to product number. Ex: THDH410_SL30D	See Sloped Seat and Skewed Ex. THDH410_SK45R_BV_SL30D	Add <i>IF</i> , one flange, right ( <i>R</i> ) and left ( <i>L</i> ), Ex. THD410_IFR
	THDH				N/A

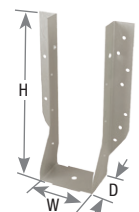
1) Skewed hangers with skews greater than 15° may have all joist nailing on outside flange. All skewed THDH hangers have nails on one side only.  
 2) Sloped or sloped / skewed hangers with slopes greater than 15° may have additional joist nails.  
 3) THDH models - Skewed hangers typically require a bevel cut. A square cut option may be available as a custom.  
 4) THD models - For skewed hangers, the required cut type (square or bevel) of joist member may vary based on skew angle and width of hanger. Some square cut hangers will require custom pricing due to welded back plate.

Joist Size (in)	MiTek USP Stock No.	Ref. No.	Web Stiff Req'd	Ga	Dimensions (in)			Fastener Schedule <sup>3</sup>				DF/SP Header Allowable Loads (Lbs.)				S-P-F Header Allowable Loads (Lbs.)				Code Ref.	
					W	H	D	Min/Max	Header		Joist <sup>2</sup>		Uplift <sup>1,2</sup>	Uplift <sup>1,2</sup>	Uplift <sup>1,2</sup>	Uplift <sup>1,2</sup>					
									Qty	Type	Qty	Type					100%	115%	125%		160%
1-1/2 x 9-1/4 - 9-1/2	IHFL15925	IUS1.56/9.5	--	18	1-1/2	9-1/16	2-1/2	--	8	10d	--	--	960	1095	1180	50	830	945	1020	40	IBC, FL
	IHF15925	MIU1.56/9	--	16	1-1/2	9-1/16	2-1/2	Min	8	10d	2	10d x 1-1/2	1000	1120	1210	330	880	990	1060	260	
								Max	20	16d			2905	2905	2905		1815	1840	1860		
1-1/2 x 11-1/4 - 11-7/8	IHFL15112	IUS1.56/11.88	--	18	1-1/2	11-1/16	2-1/2	--	10	10d	--	--	1200	1370	1475	50	1040	1185	1275	40	IBC, FL
	IHF15112	MIU1.56/11	--	16	1-1/2	11-1/16	2-1/2	Min	10	10d	2	10d x 1-1/2	1250	1405	1515	330	1100	1235	1330	260	
								Max	24	16d			3065	3095	3115		1815	1840	1860		
1-1/2 x 14	IHF1514	--	--	16	1-1/2	13-1/2	2-1/2	Min	12	10d	2	10d x 1-1/2	1500	1685	1815	330	1320	1480	1595	260	IBC, FL
								Max	28	16d			3065	3095	3115		1815	1840	1860		
								Min	8	10d	2	10d x 1-1/2	1000	1120	1210	330	880	990	1060	260	
1-5/8 x 9-1/4 - 9-1/2	IHF16925	--	--	16	1-5/8	9	2-1/2	Max	20	16d	2	10d x 1-1/2	2905	2905	2905		1945	1975	1995		IBC, FL
1-5/8 x 11-1/4 - 12	IHF16112	--	--	16	1-5/8	11	2-1/2	Min	10	10d	2	10d x 1-1/2	1250	1405	1515	330	1100	1235	1330	260	
								Max	24	16d			3295	3325	3350		1945	1975	1995		
1-5/8 x 14	IHF1614	--	--	16	1-5/8	13-7/16	2-1/2	Min	12	10d	2	10d x 1-1/2	1500	1685	1815	330	1320	1480	1595	260	IBC, FL
								Max	28	16d			3295	3325	3350		1945	1975	1995		
								Min	8	10d	2	10d x 1-1/2	1000	1120	1210	330	880	990	1060	260	
1-3/4 x 9-1/4 - 9-1/2	IHFL17925	IUS1.81/9.5	--	18	1-3/4	8-15/16	2-1/2	--	8	10d	--	--	960	1095	1180	50	830	945	1020	40	IBC, FL
	IHF17925	MIU1.81/9	--	16	1-3/4	8-15/16	2-1/2	Min	8	10d	2	10d x 1-1/2	1000	1120	1210	330	880	990	1060	260	
								Max	20	16d			2905	2905	2905		2080	2105	2125		
1-3/4 x 11-7/8	IHFL17112	IUS1.81/11.88	--	18	1-3/4	10-15/16	2-1/2	--	10	10d	--	--	1200	1370	1475	50	1040	1185	1275	40	IBC, FL
	IHF17112	MIU1.81/11	--	16	1-3/4	10-15/16	2-1/2	Min	10	10d	2	10d x 1-1/2	1250	1405	1515	330	1100	1235	1330	260	
								Max	24	16d			3530	3560	3585		2080	2105	2125		
1-3/4 x 14	IHF1714	IUS1.81/14	--	18	1-3/4	13-3/8	2-1/2	Min	12	10d	--	--	1440	1640	1770	50	1245	1420	1530	40	IBC, FL
								Max	14				1680	1915	2065		1455	1660	1785		
								Min	12	10d	2	10d x 1-1/2	1500	1685	1815	330	1320	1480	1595	260	
1-3/4 x 16	IHF1714	MIU1.81/14	--	16	1-3/4	13-3/8	2-1/2	Max	28	16d			3530	3560	3585	330	2080	2105	2125	260	IBC, FL
	IHF1716	IUS1.81/16	--	18	1-3/4	15-7/8	2-1/2	Min	14	10d	--	--	1680	1915	2065	50	1455	1660	1785	40	
								Max	16				1920	2190	2360		1660	1895	2040		
2-2-1/8 x 9-1/2	IHF1716	MIU1.81/16	--	16	1-13/16	15-3/4	2-1/2	Min	14	10d	2	10d x 1-1/2	1750	1965	2120	330	1540	1730	1865	260	IBC, FL
								Max	30	16d			3530	3560	3585		2080	2105	2125		
								Min	8	10d	--	--	960	1095	1180	50	830	945	1020	40	
2-2-1/8 x 11-7/8	IHF20925	IUS2.06/9.5	--	18	2-1/16	8-3/4	2-1/2	--	8	10d	--	--	960	1095	1180	50	830	945	1020	40	IBC, FL
	IHF20925	--	--	16	2-1/8	8-7/8	2-1/2	Min	8	10d	2	10d x 1-1/2	1000	1120	1210	330	880	990	1055	260	
								Max	20	16d			2905	2905	2905		2295	2295	2295		
2-2-1/8 x 14	IHF20112	IUS2.06/11.88	--	18	2-1/16	11-5/16	2-1/2	--	10	10d	--	--	1200	1370	1475	50	1040	1185	1275	40	IBC, FL
	IHF20112	MIU2.1/11	--	16	2-1/8	11-3/16	2-1/2	Min	10	10d	2	10d x 1-1/2	1250	1405	1515	330	1100	1235	1330	260	
								Max	24	16d			3530	3965	3965		2410	2440	2460		
2-2-1/8 x 16	IHF2014	IUS2.06/14	--	18	2-1/16	13-3/16	2-1/2	Min	12	10d	--	--	1440	1640	1770	50	1245	1420	1530	40	IBC, FL
	IHF2014	--	--	16	2-1/8	13-1/4	2-1/2	Max	14				1680	1915	2065		1455	1660	1785		
								Min	12	10d	2	10d x 1-1/2	1500	1685	1815	330	1320	1480	1595	260	
2-2-1/8 x 16	IHF2014	--	--	16	2-1/8	13-1/4	2-1/2	Max	28	16d			4115	4150	4170		2410	2440	2460		IBC, FL
	IHF2016	IUS2.06/16	--	18	2-1/16	15-11/16	2-1/2	Min	14	10d	--	--	1680	1915	2065	50	1455	1660	1785	40	
								Max	16				1920	2190	2360		1660	1895	2040		
2-5/16 x 9-1/2	IHF23925	IUS2.37/9.5	--	18	2-5/16	9-3/16	2-1/2	--	8	10d	--	--	960	1095	1180	50	830	945	1020	40	IBC, FL
	IHF23925	MIU2.37/9	--	16	2-5/16	9-3/16	2-1/2	Min	10	10d	2	10d x 1-1/2	1250	1335	1335	330	1055	1055	1055	260	
								Max	24	16d			3530	4000	4320		2675	2705	2725		

Copyright © 2019 MiTek Industries, Inc. All Rights Reserved

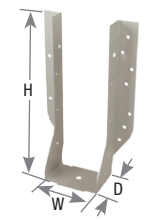
EWP Hangers

- 1) Uplift loads have been increased 60% for wind or seismic loads; no further increase shall be permitted.  
 2) IHFL (18GA) — install (2) 10d (0.148") x 1-1/2" nails through diamond dimple holes into the bottom chord of I-Joist member for a total uplift of 220 lbs.  
 IHF (16GA) — uplift capacity for hangers installed without joist nails is 65 lbs.  
 3) **NAILS:** 10d x 1-1/2 nails are 0.148" dia. x 1-1/2" long, 10d nails are 0.148" dia. x 3" long, 16d nails are 0.162" dia. x 3-1/2" long.  
**Load tables address hanger/header/fastener limitations only. Joist limitations must be determined for each installation.**  
 New products or updated product information are designated in **blue font**.



Joist Size (in)	MiTek USP Stock No.	Ref. No.	Web Stiff Req'd	Ga	Dimensions (in)			Fastener Schedule <sup>3</sup>				DF/SP Header Allowable Loads (Lbs.)				S-P-F Header Allowable Loads (Lbs.)				Code Ref.		
					W	H	D	Min/Max	Header		Joist <sup>2</sup>		100%	115%	125%	Uplift <sup>1,2</sup> 160%	100%	115%	125%		Uplift <sup>1,2</sup> 160%	
									Qty	Type	Qty	Type										
2-5/16 x 11-7/8	IHFL23112	IUS2.37/11.88	--	18	2-5/16	11-3/16	2-1/2	--	10	10d	--	--	1200	1370	1475	50	1040	1185	1275	40	IBC, FL	
	IHF23112	MIU2.37/11	--	16	2-5/16	11-3/16	2-1/2	Min	10	10d	2	10d x 1-1/2	1250	1405	1515	330	1100	1235	1330	260		
2-5/16 x 14	IHFL2314	IUS2.37/14	--	18	2-5/16	13-1/2	2-1/2	Max	24	16d	--	--	1440	1640	1770	50	1245	1420	1530	40		
	IHF2314	MIU2.37/14	--	16	2-5/16	13-1/2	2-1/2	Min	12	10d	2	10d x 1-1/2	1500	1685	1815	330	1320	1480	1595	260		
2-5/16 x 16	IHFL2316	IUS2.37/16	--	18	2-5/16	15-9/16	2-1/2	Max	28	16d	--	--	1680	1915	2065	50	1455	1660	1785	40		
	IHF2316	MIU2.37/16	--	16	2-5/16	15-9/16	2-1/2	Min	14	10d	2	10d x 1-1/2	1750	1965	2120	330	1540	1730	1865	260		
2-5/16 x 18	IHFL2318	IUS2.37/18	--	18	2-5/16	17-1/8	2-1/2	Max	30	16d	--	--	1680	1915	2065	50	1455	1660	1785	40		
	IHF2318	MIU2.37/18	--	16	2-5/16	17-1/8	2-1/2	Min	14	10d	2	10d x 1-1/2	1750	1965	2120	330	1540	1730	1865	260		
2-1/2 x 9-1/4 - 9-1/2	THFI2595	IUS2.56/9.25, IUS2.56/9.5	--	18	2-5/8	9-1/2	2-1/2	Max	16	10d	--	--	1200	1210	1210	120	950	950	950	95		IBC, FL, LA
	IHFL25925	--	--	18	2-1/2	9-1/8	2-1/2	Min	8	10d	--	--	960	1095	1180	50	830	945	1020	40		
2-1/2 x 11-1/4 - 11-7/8	IHF25925	MIU2.56/9	--	16	2-1/2	9-1/8	2-1/2	Max	24	16d	2	10d x 1-1/2	1250	1335	1335	330	1055	1055	1055	260		IBC, FL
	THFI25118	IUS2.56/11.88	--	18	2-5/8	11-7/8	2-1/2	Min	10	10d	--	--	1200	1370	1475	50	1040	1185	1275	40		IBC, FL, LA
2-1/2 x 14	IHFL25112	--	--	18	2-1/2	11-1/8	2-1/2	Max	24	16d	2	10d x 1-1/2	1250	1335	1335	330	1055	1055	1055	260	IBC, FL	
	IHF25112	MIU2.56/11	--	16	2-1/2	11-1/8	2-1/2	Min	10	10d	--	--	1200	1210	1210	120	950	950	950	95	IBC, FL, LA	
2-1/2 x 16	THFI2514	IUS2.56/14	--	18	2-5/8	14	2-1/2	Max	14	10d	--	--	1440	1640	1770	120	1265	1445	1555	95	IBC, FL, LA	
	IHFL2514	--	--	18	2-1/2	13-7/16	2-1/2	Min	12	10d	--	--	1440	1640	1770	50	1245	1420	1530	40		
2-1/2 x 16	IHF2514	MIU2.56/14	--	16	2-1/2	13-7/16	2-1/2	Max	14	10d	2	10d x 1-1/2	1500	1685	1815	330	1320	1480	1595	260		
	IHFL2516	IUS2.56/16	--	18	2-1/2	15-1/2	2-1/2	Min	12	10d	--	--	1680	1915	2065	50	1455	1660	1785	40		
2-5/8 x 9-1/4 - 9-1/2	IHF2516	MIU2.56/16	--	16	2-1/2	15-1/2	2-1/2	Max	28	16d	2	10d x 1-1/2	1750	1965	2120	330	1540	1730	1865	260		
	IHF26925	--	--	16	2-5/8	9-1/16	2-1/2	Min	14	10d	--	--	1680	1915	2065	50	1455	1660	1785	40		
2-5/8 x 11-1/4 - 11-7/8	IHF26112	--	--	16	2-5/8	11-1/16	2-1/2	Max	16	10d	2	10d x 1-1/2	1920	2190	2360	330	1660	1895	2040	40		
	IHF26112	--	--	16	2-5/8	11-1/16	2-1/2	Min	10	10d	2	10d x 1-1/2	1250	1335	1335	330	1055	1055	1055	260		
2-5/8 x 14	IHF2614	--	--	16	2-5/8	13-3/8	2-1/2	Max	24	16d	2	10d x 1-1/2	3530	4000	4320	330	3010	3035	3055	260		
	IHF2614	--	--	16	2-5/8	13-3/8	2-1/2	Min	12	10d	2	10d x 1-1/2	1500	1685	1815	330	1320	1480	1595	260		
2-5/8 x 16	IHF2616	--	--	16	2-5/8	15-7/16	2-1/2	Max	28	16d	2	10d x 1-1/2	4115	4440	4440	330	3010	3035	3055	260		
	IHF2616	--	--	16	2-5/8	15-7/16	2-1/2	Min	14	10d	2	10d x 1-1/2	1750	1965	2120	330	1540	1730	1865	260		
3 x 9-1/4	IHF15925-2	MIU3.12/9	--	16	3-1/8	9-3/16	2-1/2	Max	30	16d	2	10d x 1-1/2	4410	4440	4440	330	3010	3035	3055	260		
	IHF15925-2	MIU3.12/9	--	16	3-1/8	9-3/16	2-1/2	Min	10	10d	2	10d x 1-1/2	1250	1335	1335	330	1055	1055	1055	260		
3 x 11-1/4	IHF15112-2	MIU3.12/11	--	16	3-1/8	10-13/16	2-1/2	Max	24	16d	2	10d x 1-1/2	3530	4000	4320	330	3105	3435	3455	260		
	IHF15112-2	MIU3.12/11	--	16	3-1/8	10-13/16	2-1/2	Min	10	10d	2	10d x 1-1/2	1250	1335	1335	330	1055	1055	1055	260		

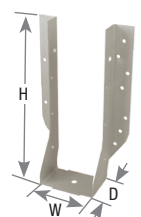
1) Uplift loads have been increased 60% for wind or seismic loads; no further increase shall be permitted.  
 2) IHFL (18GA) — install (2) 10d (0.148") x 1-1/2" nails through diamond dimple holes into the bottom chord of I-Joist member for a total uplift of 220 lbs.  
 IHF (16GA) — uplift capacity for hangers installed without joist nails is 65 lbs.  
**2) NAILS:** 10d x 1-1/2" nails are 0.148" dia. x 1-1/2" long, 10d nails are 0.148" dia. x 3" long, 16d nails are 0.162" dia. x 3-1/2" long.  
**Load tables address hanger/header/fastener limitations only. Joist limitations must be determined for each installation.**  
 New products or updated product information are designated in blue font.



Copyright © 2019 MiTek Industries, Inc. All Rights Reserved

Joist Size (in)	MiTek USP Stock No.	Ref. No.	Web Stiff Req'd	Ga	Dimensions (in)			Fastener Schedule <sup>3</sup>				DF/SP Header Allowable Loads (Lbs.)				S-P-F Header Allowable Loads (Lbs.)				Code Ref.	
					W	H	D	Min/Max	Header		Joist <sup>2</sup>		100%	115%	125%	Uplift <sup>1,2</sup>	100%	115%	125%		160%
									Qty	Type	Qty	Type									
3-1/4 x 9-1/4	IHF16925-2	--	--	16	3-3/8	9-1/16	2-1/2	Min	10	10d	2	10d x 1-1/2	1250	1335	1335	330	1055	1055	1055	260	
								Max	24	16d			3530	4000	4320		3105	3520	3720		
3-1/4 x 11-1/4	IHF16112-2	--	--	16	3-3/8	10-3/4	2-1/2	Min	10	10d	2	10d x 1-1/2	1250	1335	1335	330	1055	1055	1055	260	
								Max	24	16d			3530	3965	3965		3105	3125	3125		
3-1/2 x 9-1/4 - 9-1/2	IHF35925	IUS3.56/9.5	--	18	3-1/2	8-5/8	2-1/2	--	10	10d	--	--	1200	1370	1475	50	1040	1185	1275	40	
	IHF35925	MIU3.56/9	--	16	3-1/2	8-5/8	2-1/2	Min	10	10d	2	10d x 1-1/2	1250	1335	1335		330	1055	1055		1055
3-1/2 x 11-1/4 - 11-7/8	IHF35112	IUS3.56/11.88	--	18	3-1/2	10-5/8	2-1/2	Min	10	10d	--	--	1200	1370	1475	50		1040	1185	1275	40
	IHF35112	MIU3.56/11	--	16	3-1/2	10-5/8	2-1/2	Max	12	10d	2	10d x 1-1/2	1440	1640	1770		330	1245	1420	1530	
3-1/2 x 14	IHF3514	IUS3.56/14	--	18	3-1/2	12-15/16	2-1/2	Min	12	10d	--	--	1440	1640	1770	50		1245	1420	1530	40
	IHF3514	MIU3.56/14	--	16	3-1/2	12-15/16	2-1/2	Max	14	10d	2	10d x 1-1/2	1680	1915	2065		330	1455	1660	1785	
3-1/2 x 16	IHF3516	IUS3.56/16	--	18	3-1/2	15	2-1/2	Min	14	10d	--	--	1680	1915	2065	50		1455	1660	1785	40
	IHF3516	MIU3.56/16	--	16	3-1/2	15	2-1/2	Max	16	10d	2	10d x 1-1/2	1920	2190	2360		330	1660	1895	2040	
	THF17157-2	--	x	12	3-5/8	15-3/4	2-1/2	--	22	10d	6	10d	2925	3365	3660	1275		2560	2945	3200	1115
3-1/2 x 18	IHF3518	MIU3.56/18	--	16	3-1/2	16-9/16	2-1/2	Min	14	10d	2	10d x 1-1/2	1750	1965	2120	330	1540	1730	1865	260	
								Max	30	16d	2	10d x 1-1/2	4410	4440	4440		330	3880	3965		3985
4 - 4-3/16 x 9-1/2	IHF20925-2	MIU4.12/9, MIU4.28/9	--	16	4-3/16	8-11/16	2-1/2	Min	10	10d	2	10d x 1-1/2	1250	1405	1515	330		1100	1235	1330	260
								Max	24	16d	2	10d x 1-1/2	3530	3965	3965		330	3105	3120	3120	
4 - 4-3/16 x 11-7/8	IHF20112-2	MIU4.12/11, MIU4.28/11	--	16	4-3/16	11	2-1/2	Min	10	10d	2	10d x 1-1/2	1250	1405	1515	330		1100	1235	1330	260
								Max	24	16d	2	10d x 1-1/2	3530	3965	3965		330	3105	3120	3120	
4 - 4-3/16 x 14	IHF2014-2	MIU4.12/14, MIU4.28/14	--	16	4-3/16	13-5/8	2-1/2	Min	12	10d	2	10d x 1-1/2	1500	1685	1815	330		1320	1480	1595	260
								Max	28	16d	2	10d x 1-1/2	3965	3965	3965		330	3120	3120	3120	
4-5/8 x 9-1/4	IHF23925-2	MIU4.75/9	--	16	4-3/4	8-3/8	2-1/2	Min	10	10d	2	10d x 1-1/2	1250	1405	1515	330		1100	1235	1330	260
								Max	24	16d	2	10d x 1-1/2	3530	3965	3965		330	3105	3120	3120	
4-5/8 x 11-1/4	THF23118-2	--	x	16	4-3/4	10-11/16	2-1/2	--	16	10d	6	10d	1890	2170	2360	1135		1650	1900	2065	990
4-5/8 x 14	THF23140-2	MIU4.75/14	x	12	4-3/4	13-5/16	2-1/2	--	20	10d	6	10d	2660	3060	3325	1275	2325	2675	2910	1115	IBC, FL, LA
4-5/8 x 16	THF23160-2	MIU4.75/16	x	12	4-3/4	15-15/16	2-1/2	--	24	10d	6	10d	3190	3670	3790	1275	2790	3000	3000	1115	IBC, FL, LA
5 x 9-1/4	IHF25925-2	MIU5.12/9	--	16	5-1/8	8-3/16	2-1/2	Min	10	10d	2	10d x 1-1/2	1250	1405	1515	330	1100	1235	1330	260	
								Max	24	16d			3530	3965	3965		3105	3120	3120		
5 x 11-1/4	IHF25112-2	MIU5.12/11	--	16	5-1/8	10-7/16	2-1/2	Min	10	10d	2	10d x 1-1/2	1250	1405	1515	330	1100	1235	1330	260	
								Max	24	16d			3530	3965	3965		3105	3120	3120		
5 x 14	THF25140-2	MIU5.12/14	x	12	5-1/8	13-1/8	2-1/2	--	20	10d	6	10d	2660	3060	3325	1235	2340	2690	2925	975	IBC, FL, LA
5 x 16	THF25160-2	MIU5.12/16	x	12	5-1/8	15-3/4	2-1/2	--	24	10d	6	10d	3190	3670	3790	1235	2810	3000	3000	975	IBC, FL, LA
7 x 9-1/4	HD7100	HU410-2	x	14	7-1/8	9	2-1/2	Min	14	16d	6	16d	2155	2430	2610	1305	1895	2140	2295	1035	
								Max	18	8			2770	3125	3355		1845	2440	2750	2950	1585
7 x 11-1/4	HD7120	HU412-2	x	14	7-1/8	10-11/16	2-1/2	Min	16	16d	6	16d	2465	2780	2980	1305	2165	2445	2620	1035	
								Max	22	8			3390	3820	4100		1845	2980	3360	3605	1620
7 x 14	HD7140	HU414-2	x	14	7-1/8	13	2-1/2	Min	20	16d	8	16d	3080	3475	3715	1845	2710	2940	2940	1585	
								Max	26	12			4005	4435	4435		2765	3520	3710	3710	2430

1) Uplift loads have been increased 60% for wind or seismic loads; no further increase shall be permitted.  
 2) IHFL (18GA) — install (2) 10d (0.148") x 1-1/2" nails through diamond dimple holes into the bottom chord of I-Joist member for a total uplift of 220 lbs.  
 IHF (16GA) — uplift capacity for hangers installed without joist nails is 65 lbs.  
 2) **NAILS:** 10d x 1-1/2 nails are 0.148" dia. x 1-1/2" long, 10d nails are 0.148" dia. x 3" long, 16d nails are 0.162" dia. x 3-1/2" long.  
**Load tables address hanger/header/fastener limitations only. Joist limitations must be determined for each installation.**  
 New products or updated product information are designated in blue font.

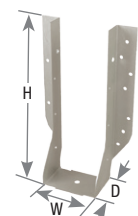


Copyright © 2019 MiTek Industries, Inc. All Rights Reserved

EWP Hangers

Joist Size (in)	MiTek USP Stock No.	Ref. No.	Web Stiff Req'd	Ga	Dimensions (in)			Fastener Schedule <sup>2,3</sup>				DF/SP Header Allowable Loads (Lbs.)				S-P-F Header Allowable Loads (Lbs.)				Code Ref.	
					W	H	D	Min/Max	Header		Joist		100%	115%	125%	Uplift <sup>1</sup> 160%	100%	115%	125%		Uplift <sup>1</sup> 160%
									Qty	Type	Qty	Type									
1-3/4 x 7-1/4	HD1770	HU7	x	14	1-13/16	7-1/8	2-1/2	Min	12	16d	4	10d x 1-1/2	1850	2085	2235	760	1625	1835	1890	610	IBC, FL, LA
								Max	16		8		2465	2780	2980	1180	2165	2445	2620	955	
1-3/4 x 9-1/2	HD17925	HU9	x	14	1-13/16	9-1/8	2-1/2	Min	18	16d	6	10d x 1-1/2	2770	3125	3355	1170	2440	2645	2695	950	IBC, FL, LA
								Max	24		10		3695	4170	4320	1900	3020	3165	3255	1540	
	HDQ1791F	--	x	14	1-13/16	9	3	--	8	WS3	4	WS15	3340	3605	3605	1110	2980	3010	3010	925	IBC, FL, LA
	HUS179	HUS1.81/10	x	16	1-13/16	9-1/8	3	--	30	16d	10	16d	5580	6040	6040	4110	4555	4880	4895	3390	IBC, FL, LA
1-3/4 x 11-1/4 - 11-7/8	HD17112	HU11	x	14	1-13/16	11-3/8	2-1/2	Min	22	16d	6	10d x 1-1/2	3390	3625	3685	1170	2555	2645	2695	950	IBC, FL, LA
								Max	30		12		4320	4515	4640	1900	3255	3425	3535	1550	
	HDQ17112IF	--	x	14	1-13/16	11-3/8	--	--	22	16d	6	10d x 1-1/2	<b>3390</b>	<b>3625</b>	<b>3685</b>	<b>1170</b>	<b>2555</b>	<b>2645</b>	<b>2695</b>	<b>950</b>	--
	HUS179	HUS1.81/10	x	16	1-13/16	9-1/8	3	--	30	16d	10	16d	5580	6040	6040	4110	4555	4880	4895	3390	IBC, FL, LA
1-3/4 x 14	HD1714	HU14, U14	x	14	1-13/16	13-5/16	2-1/2	Min	28	16d	8	10d x 1-1/2	3790	3920	4005	1550	2790	2905	2975	1255	IBC, FL, LA
								Max	36		14		4580	4810	4955	1900	3485	3685	3815	1555	
	HDQ1714IF	--	x	14	1-13/16	13-5/16	--	--	28	16d	8	10d x 1-1/2	<b>3790</b>	<b>3920</b>	<b>4005</b>	<b>1550</b>	<b>2790</b>	<b>2905</b>	<b>2975</b>	<b>1255</b>	--
	HUS179	HUS1.81/10	x	16	1-13/16	9-1/8	3	--	30	16d	10	16d	5580	6040	6040	4110	4555	4880	4895	3390	IBC, FL, LA
1-3/4 x 16	HD1714	HU14, U14	x	14	1-13/16	13-5/16	2-1/2	Min	28	16d	8	10d x 1-1/2	3790	3920	4005	1550	2790	2905	2975	1255	IBC, FL, LA
								Max	36		14		4580	4810	4955	1900	3485	3685	3815	1555	
	HDQ1714IF	--	x	14	1-13/16	13-3/8	3	--	12	WS3	6	WS15	4660	4870	4955	2035	3355	3525	3635	1680	--
2-11/16 x 9-1/4 - 14	HD27925	HU2.75/10	x	14	2-3/4	9-3/16	2-1/2	Min	14	16d	6	10d x 1-1/2	2155	2430	2610	1170	1895	2140	2295	940	IBC, FL, LA
								Max	20		10		3080	3475	3715	1550	2710	2980	2980	1245	
	THDH27925	--	x	12	2-3/4	9-1/8	4	--	46	16d	12	16d	9020	9020	9020	4445	7515	7900	7975	3560	IBC, FL, LA
2-11/16 x 11-1/4 - 16	HD27112	HU2.75/12	x	14	2-3/4	11-3/16	2-1/2	Min	16	16d	8	10d x 1-1/2	2465	2780	2980	1180	2165	2445	2620	945	IBC, FL, LA
								Max	24		12		3695	4170	4435	1900	3250	3665	3760	1530	
	THDH27112	--	x	12	2-3/4	10-7/8	4	--	56	16d	14	16d	9710	9710	9710	4445	7795	7795	7795	3570	IBC, FL, LA

1) Uplift loads have been increased 60% for wind or seismic loads; no further increase shall be permitted.  
 2) WS15 Wood Screws are 1/4" dia. x 1-1/2" long, WS3 Wood Screws are 1/4" dia. x 3" long and are included with HDQ hangers.  
 3) **NAILS:** 10d x 1-1/2 nails are 0.148" dia. x 1-1/2" long, 10d nails are 0.148" dia. x 3" long, 16d nails are 0.162" dia. x 3-1/2" long.  
**Load tables address hanger/header/fastener limitations only. Joist limitations must be determined for each installation.**  
 New products or updated product information are designated in **blue font**.



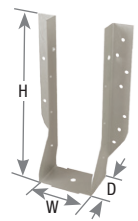


Joist Size (in)	MiTek USP Stock No.	Ref. No.	Web Stiff Req'd	Ga	Dimensions (in)			Fastener Schedule <sup>2,3</sup>				DF/SP Header Allowable Loads (Lbs.)				S-P-F Header Allowable Loads (Lbs.)				Corrosion Finish	Code Ref.	
					W	H	D	Min/Max	Header		Joist		100%	115%	125%	Uplift <sup>1</sup> 160%	100%	115%	125%			Uplift <sup>1</sup> 160%
									Qty	Type	Qty	Type										
2-11/16 x 14 - 16	HD2714	HU2.75/14	x	14	2-3/4	13-3/16	2-1/2	Min 18	18	16d	8	10d x 1-1/2	2770	3125	3355	1550	2440	2750	2950	1240		
	THD2714	--	x	12	2-3/4	12-1/4	4	Max 26	66	16d	12	16d	4005	4435	4435	1900	3520	3760	3760	1530		
3-1/2 x 9-1/4 - 14	HD410	--	x	14	3-9/16	8-13/16	2-1/2	Min 14	14	16d	6	10d	2155	2430	2610	1170	1895	2140	2295	1030		
	HDQ410IF	HUCQ410-SDS	x	14	3-9/16	9	3	Max 20	12	WS3	6	WS3	3080	3475	3715	1950	2710	2970	2970	1715		
	THD410	HHUS410	x	14	3-5/8	9-1/16	3	--	38	16d	20	10d	5850	6600	7045	3905	5145	5680	5680	3235		
	THDH410	HGUS410	x	12	3-5/8	9-1/16	4	--	46	16d	12	16d	9020	9020	9020	4445	7950	7950	7950	3545		
3-1/2 x 11-1/4 - 16	HD412	--	x	14	3-9/16	10-13/16	2-1/2	Min 16	16	16d	8	10d	2465	2780	2980	1305	2165	2445	2620	1040		
	HDQ412IF	HUCQ412-SDS	x	14	3-9/16	11	3	Max 24	14	WS3	6	WS3	3695	4170	4470	2340	3250	3665	3860	2060		
	THD412	--	x	14	3-5/8	11	3	--	48	16d	20	10d	5605	5605	5605	3280	4980	4980	4980	2775		
	THDH412	HGUS412	x	12	3-5/8	11-1/16	4	--	56	16d	14	16d	7045	7045	7045	3905	5680	5680	5680	3235		
3-1/2 x 14 - 20	HD414	--	x	14	3-9/16	12-13/16	2-1/2	Min 18	18	16d	8	10d	2770	3125	3355	1550	2440	2750	2950	1235		
	THD414	--	x	14	3-5/8	12-7/8	3	Max 26	58	16d	20	10d	4005	4515	4815	2340	3520	3860	3860	2060		
	THDH414	HGUS414	x	12	3-5/8	13-1/16	4	--	66	16d	16	16d	7045	7045	7045	3905	5680	5680	5680	3235		
3-1/2 x 16 - 22	HD416	--	x	14	3-9/16	14-13/16	2-1/2	Min 22	22	16d	10	10d	3390	3820	4100	1950	2980	3360	3605	1715		
	THD416	--	x	14	3-9/16	16-1/2	2-1/2	Max 30	28	16d	14	10d	4620	4965	4965	2245	3990	3990	3990	1805		
3-1/2 x 18 - 26	HD418	--	x	14	3-9/16	16-1/2	2-1/2	--	28	16d	8	10d	4310	4815	4815	1560	3795	3835	3835	1375		
5-1/4 x 9-1/4 - 11-7/8	HD5210	--	x	14	5-3/8	7-7/8	2-1/2	Min 14	14	16d	6	16d	2155	2430	2610	1305	1895	2140	2295	1035		
	HDQ5210IF	HUCQ5.25/9-SDS	x	14	5-1/4	9	3	Max 20	12	WS3	6	WS3	3080	3475	3725	2305	2710	3055	3275	2025		
	THD610	HHUS5.50/10	x	12	5-1/2	9	3	--	38	16d	20	10d	5015	5590	5590	2975	4670	4890	4890	2855		
	THDH610	HGUS5.25/10, HGUS5.50/10	x	12	5-1/2	9	4	--	46	16d	16	16d	6535	7255	7745	4010	5750	6380	6810	3210		

IBC, FL, LA

1) Uplift loads have been increased 60% for wind or seismic loads; no further increase shall be permitted.  
 2) WS3 Wood Screws are 1/4" dia. x 3" long and are included with HDQ hangers.  
 3) **NAILS:** 10d x 1-1/2 nails are 0.148" dia. x 1-1/2" long, 10d nails are 0.148" dia. x 3" long, 16d nails are 0.162" dia. x 3-1/2" long.  
**Load tables address hanger/header/fastener limitations only. Joist limitations must be determined for each installation.**  
 New products or updated product information are designated in **blue font**.

**Corrosion Finish** ■ Stainless Steel ■ Gold Coat ■ HDG ■ Triple Zinc



Copyright © 2019 MiTek Industries, Inc. All Rights Reserved

EWP Hangers

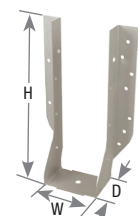
Joist Size (in)	MiTek USP Stock No.	Ref. No.	Web Stiff Req'd	Ga	Dimensions (in)			Fastener Schedule <sup>2,3</sup>				DF/SP Header Allowable Loads (Lbs.)				S-P-F Header Allowable Loads (Lbs.)				Code Ref.	
					W	H	D	Min/Max	Header		Joist		100%	115%	125%	Uplift <sup>1</sup>	100%	115%	125%		Uplift <sup>1</sup>
									Qty	Type	Qty	Type									
5-1/4 x 11-1/4 - 16	HD5212	--	x	14	5-3/8	9-7/8	2-1/2	Min	16	16d	8	16d	2465	2780	2980	1305	2165	2445	2620	1040	IBC, FL, LA
								Max	24	16d	12	16d	3695	4170	4470	2765	3250	3665	3930	2430	
	HDQ5212IF	HUCQ5.25/11-SDS	x	14	5-1/4	11	3	--	14	WS3	6	WS3	5605	5605	5605	3280	4965	4965	4965	2770	
	THD612	--	x	12	5-1/2	11	3	--	48	16d	20	10d	8255	8860	8860	4010	7090	7090	7090	3210	
	THDH612	HGUS5.25/12, HGUS5.50/12	x	12	5-1/2	11	4	--	56	16d	20	16d	9740	9740	9740	5260	7775	7775	7775	4200	
5-1/4 x 14 - 20	HD5214	--	x	14	5-3/8	11-7/8	2-1/2	Min	18	16d	8	16d	2770	3125	3355	1845	2440	2750	2950	1590	
								Max	26	16d	12	16d	4005	4515	4845	2765	3520	3970	4020	2430	
	THD614	--	x	12	5-1/2	12-7/8	3	--	58	16d	20	10d	8860	8860	8860	4010	7090	7090	7090	3210	
	THDH614	HGUS5.50/14	x	12	5-1/2	13	4	--	66	16d	22	16d	11760	11760	11760	5655	9400	9400	9400	4520	
5-1/4 x 16 - 22	HD5216	--	x	14	5-3/8	13-7/8	2-1/2	Min	22	16d	10	16d	3390	3820	4100	2305	2980	3360	3605	2025	
								Max	30	16d	14	16d	4620	4965	4965	3225	3975	3975	3975	2835	
6-3/4 x 9 - 14	THDH6710	HGUS210-4, HGUS6.88/10	x	12	6-7/8	8-13/16	4	--	46	16d	12	16d	9020	9020	9020	4445	7890	7890	7890	3520	
6-3/4 x 11 - 18	THDH6712	HGUS212-4, HGUS6.88/12	x	12	6-7/8	10-13/16	4	--	56	16d	14	16d	9020	9020	9020	5260	7900	7900	7900	4175	
6-3/4 x 13 - 20	THDH6714	HGUS214-4, HGUS6.88/14	x	12	6-7/8	12-13/16	4	--	66	16d	16	16d	11760	11760	11760	5655	9340	9340	9340	4490	
7 x 9-1/4 - 14	HD7100	HU410-2	x	14	7-1/8	9	2-1/2	Min	14	16d	6	16d	2155	2430	2610	1305	1895	2140	2295	1035	
								Max	18	16d	8	16d	2770	3125	3355	1845	2440	2750	2950	1585	
	THD7210	HHUS7.25/10	x	12	7-1/4	9	3	--	38	16d	20	10d	6535	7255	7745	4010	5750	6380	6810	3200	
	THDH7210	HGUS7.25/10	x	12	7-1/4	9	4	--	46	16d	12	16d	9020	9020	9020	4445	7890	7890	7890	3520	
7 x 11-1/4 - 16	HD7120	HU412-2	x	14	7-1/8	10-11/16	2-1/2	Min	16	16d	6	16d	2465	2780	2980	1305	2165	2445	2620	1035	
								Max	22	16d	8	16d	3390	3820	4100	1845	2980	3360	3605	1620	
	THDH7212	HGUS7.25/12	x	12	7-1/4	10-1/2	4	--	56	16d	14	16d	9020	9020	9020	5260	7900	7900	7900	4170	
7 x 14 - 20	HD7140	HU414-2	x	14	7-1/8	13	2-1/2	Min	20	16d	8	16d	3080	3475	3715	1845	2710	2940	2940	1585	
								Max	26	16d	12	16d	4005	4435	4435	2765	3520	3710	3710	2430	
	THDH7214	HGUS7.25/14	x	12	7-1/4	12-1/4	4	--	66	16d	16	16d	11760	11760	11760	5655	9335	9335	9335	4490	
7 x 16 - 22	HD7160	--	x	14	7-1/8	15-5/8	2-1/2	--	24	16d	8	10d	3695	4170	4435	1560	3250	3665	3695	1375	
7 x 18 - 26	HD7180	--	x	14	7-1/8	17-3/4	2-1/2	--	28	16d	8	10d	4310	4815	4815	1560	3795	3810	3810	1375	

1) Uplift loads have been increased 60% for wind or seismic loads; no further increase shall be permitted.

2) WS3 Wood Screws are 1/4" dia. x 3" long and are included with HDQ hangers.

3) **NAILS:** 10d nails are 0.148" dia. x 3" long, 16d nails are 0.162" dia. x 3-1/2" long.

**Load tables address hanger/header/fastener limitations only. Joist limitations must be determined for each installation.**



**TFI & THO** – Engineered for I-Joist to header applications. Offers full lateral support of the I-Joist top chord, eliminating the need for web stiffeners in most applications. Raised dimple nailing guides help assure correct 45° nailing into the I-Joist bottom flange. The THO's feature the patented Seat Cleat® that allows for quick, positive seating. The Seat Cleat® will hold the I-Joist in place, eliminating spring back during nailing in the bottom flange.

**TFL** – Features 1-1/2" top flange depth that accommodates all header types as well as back-to-back installations. Also features MiTek's patented Seat Cleat® for quick, positive seating.

**Materials:** See EWP Top Mount Hangers charts, pages 199-204.

**Finish:** G90 galvanizing

**Codes:** See page 12 for Code Reference Chart

**Patents:** U.S. Patent No. 5,564,248 – THO & TFL

**Installation:**

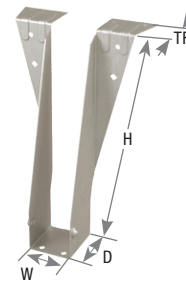
- Use all specified fasteners. See Product Notes, page 20.
- Refer to the top mount chart for applications requiring web stiffeners.
- Requirements for web stiffener from the I-Joist manufacturer should be followed, even if web stiffeners are not required in MiTek literature.
- Uplift capacity for THO and TFL single-ply hangers installed without joist nails = 85 lbs. Refer to THO, TFL, & THF Single-Ply I-Joist Hangers Technical Bulletin.



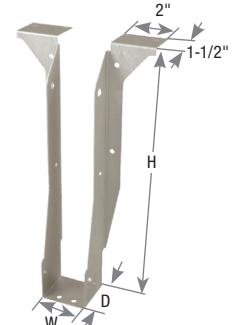
Typical THO installation



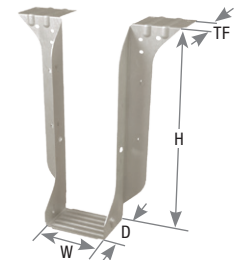
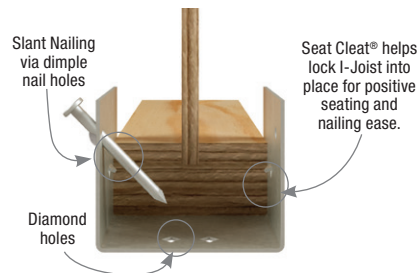
Typical TFL installation



THO



TFL



TFI

**Nailer Options**

– chart represents maximum allowable loads for hangers used on wood nailers. Reference page 183.

MiTek USP Series	Nailer Size	Fastener Schedule <sup>3</sup>				DF/ SP		SPF	
		Nailer		Joist		Allowable Loads (Lbs.) <sup>2</sup>		Allowable Loads (Lbs.) <sup>2</sup>	
		Qty	Type	Qty	Type	100%	Uplift <sup>1</sup>	100%	Uplift <sup>1</sup>
TFL	2X	6	10d x 1-1/2	2	10d x 1-1/2	1270	130	1090	110
	3X	6	16d x 2-1/2	2	10d x 1-1/2	1600	130	1230	110
	(2) 2X	6	10d	2	10d x 1-1/2	1280	130	1100	110
	4X	6	16d	2	10d x 1-1/2	1600	130	1230	110
THO	2X	6	10d x 1-1/2	2	10d x 1-1/2	1360	230	1170	195
	3X	6	16d x 2-1/2	2	10d x 1-1/2	1335	230	1050	195
	(2) 2X	6	16d x 2-1/2	2	10d x 1-1/2	1335	230	1050	195
	4X	6	16d	2	10d x 1-1/2	1335	230	1050	195
THO (Double)	2X	6	10d x 1-1/2	2	10d x 1-1/2	1455	230	1250	195
	3X	6	16d x 2-1/2	2	10d x 1-1/2	2335	230	2010	195
	(2) 2X	6	10d	2	10d x 1-1/2	2370	230	2040	195
	4X	6	16d	2	10d x 1-1/2	2665	230	2290	195
TFI	2X	6	10d x 1-1/2	2	10d x 1-1/2	1985	215	1660	180
	3X	10	16d x 2-1/2	2	10d x 1-1/2	2560	215	1660	180
	(2) 2X	10	10d	2	10d x 1-1/2	2560	215	1660	180
	4X	6	16d	2	10d x 1-1/2	2560	215	2200	180
	4X	10	16d	2	10d x 1-1/2	3245	215	2200	180

1) Uplift loads have been increased 60% for wind or seismic loads; no further increase shall be permitted.  
 2) Listed loads shall not be increased.  
 3) **NAILS:** 10d x 1-1/2 nails are 0.148" dia. x 1-1/2" long, 10d nails are 0.148" dia. x 3" long, 16d nails are 0.162" dia. x 3-1/2" long, 16d x 2-1/2 nails are 0.162" dia. x 2-1/2" long. New products or updated product information are designated in blue font.

These hangers are used to support LVL, LSL, and PSL beams and headers in medium-to-heavy load conditions.

**Materials:** BPH – 12 gauge; HBPH – 10 gauge

**Finish:** G90 galvanizing

**Codes:** See page 12 for Code Reference Chart

**Installation:**

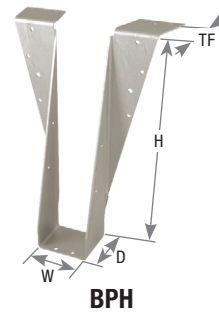
- Use all specified fasteners. See Product Notes, page 20.
- Refer to the top mount chart for applications requiring web stiffeners.
- Requirements for web stiffener from the I-Joist manufacturer should be followed, even if web stiffeners are not required in MiTek literature.
- For welded installations, see page 287.



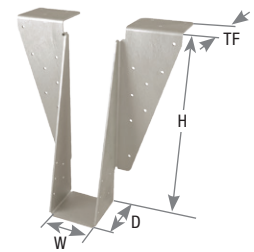
**Typical BPH installation**



**Typical HBPH installation**



**BPH**



**HBPH**

**Nailer Options**

– chart represents maximum allowable loads for hangers used on wood nailers. Reference page 183.

MiTek USP Series	Nailer Size	Fastener Schedule <sup>3</sup>				DF/SP Allowable Loads (Lbs.) <sup>2</sup>		S-P-F Allowable Loads (Lbs.) <sup>2</sup>	
		Header		Joist		100%	Uplift <sup>1</sup> 160%	100%	Uplift <sup>1</sup> 160%
		Qty	Type	Qty	Type				
BPH	2X	6	10d x 1-1/2	4	10d x 1-1/2	2080	230	1790	200
	3X	8	16d x 2-1/2	4	10d x 1-1/2	2360	535	2030	460
	(2) 2X	8	10d	4	10d x 1-1/2	2310	535	1985	460
	4X	8	16d	4	10d x 1-1/2	2245	535	1930	460
HBPH	2X	8	10d x 1-1/2	10	16d	2540	--	2135	--
	3X	12	16d x 2-1/2	10	10d	4500	--	3780	--
	(2) 2X	14	10d	10	16d	4140	1610	3480	1350
	4X	16	16d	10	16d	5745	1610	4825	1350

- 1) Uplift loads have been increased 60% for wind or seismic loads; no further increase shall be permitted.
- 2) Listed loads shall not be increased.
- 3) **NAILS:** 10d x 1-1/2 nails are 0.148" dia. x 1-1/2" long, 10d nails are 0.148" dia. x 3" long, 16d nails are 0.162" dia. x 3-1/2" long, 16d x 2-1/2 nails are 0.162" dia. x 2-1/2" long.

**Specialty Options Chart**

– refer to Specialty Options pages 283 and 285 for additional details

Option	Skewed <sup>1,3</sup>	Sloped Seat <sup>2,3</sup>	Sloped / Skewed <sup>1,2,3</sup>	Sloped Top Flange <sup>4</sup>
<b>Range</b>	1° to 50°	1° to 45°	See Sloped Seat and Skewed	0° to 45°
<b>Allowable Loads</b>	100% of table load	100% of table load	100% of table load	100% of table load
<b>Ordering</b>	Add <i>SK</i> , angle required, right ( <i>R</i> ) or left ( <i>L</i> ), and <b>square cut (<i>SQ</i>) or bevel cut (<i>BV</i>)</b> to product number. Example: BPH3595_SK45R_SQ	Add <i>SL</i> , slope required, and up ( <i>U</i> ) or down ( <i>D</i> ), to product number. Example: BPH3595_SL30D	See Sloped Seat and Skewed. Example: BPH3595_SK45R_SQ_SL30D	Add <i>SF</i> , angle required and right ( <i>R</i> ) or left ( <i>L</i> ), to product number. Example: BPH3595_SF30L

- 1) Skewed hangers with skews greater than 15° may have all joist nailing on outside flange.
- 2) Sloped or sloped / skewed hangers with slopes greater than 15° may have additional joist nails.
- 3) For skewed hangers, the required cut type (square or bevel) of joist member may vary based on skew angle and width of hanger. Some square cut hangers will require custom pricing due to welded back plate.
- 4) Sloped top flanges with slopes greater than 15° may have additional header nails.

Heavy-duty hanger for LVL, LSL, and PSL beams.

**Materials:** 7 gauge

**Finish:** Primer

**Codes:** See page 12 for Code Reference Chart

**Installation:**

- Use all specified fasteners. See Product Notes, page 20.
- For welded installations, see page 287.
- 16d ring shank nails are supplied with HLBH hangers.

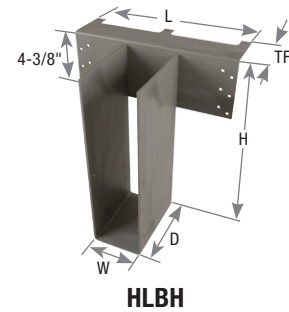


**Typical HLBH installation**

**Nailer Options**

– chart represents maximum allowable loads for hangers used on wood nailers. Reference page 183.

MiTek USP Series	Nailer Size	Fastener Schedule <sup>2</sup>				DF/SP Allowable Loads (Lbs.)		SPF Allowable Loads (Lbs.)	
		Nailer		Joist		100%	Uplift 160%	100%	Uplift 160%
		Qty	Type	Qty	Type				
HLBH	2x	7	10d x 1-1/2	6	10d x 1-1/2	6115	--	5135	--
	3x	9	16d x 2-1/2	6	10d	6825	--	5735	--
	(2) 2x	11	10d	6	10d x 1-1/2	4385	--	3685	--
	4X	11	NA16D-RS	6	10d x 1-1/2	9600	<b>1115</b>	8255	<b>935</b>
	4X	11	NA16D-RS	6	16d	9600	<b>1115</b>	8255	<b>935</b>



**HLBH**

- 1) Listed loads shall not be increased.
- 2) **NAILS:** 10d x 1-1/2 nails are 0.148" dia. x 1-1/2" long, 10d nails are 0.148" dia. x 3" long, NA16D-RS nails are 0.148 dia. x 3-1/2" long, 16d nails are 0.162" dia. x 3-1/2" long. New products or updated product information are designated in **blue font**.

**Specialty Options Chart**

– refer to Specialty Options pages 283, 285-286 for additional details

Option	Skewed <sup>1,3</sup>	Sloped Seat <sup>2,3</sup>	Sloped / Skewed <sup>1,2,3</sup>	Sloped Top Flange <sup>4</sup>	Top Flange Offset	Saddle <sup>5</sup>	Ridge
<b>Range</b>	1° to 50°	1° to 45°	See Sloped Seat and Skewed	0° to 45°	--	--	0° to 45°
<b>Allowable Loads</b>	8070 lbs. Max. 50% of uplift load on skew greater than 15°.	7000 lbs. Max.	6650 lbs. Max. 50% of uplift load on skew greater than 15°.	100% of table load	45% of table load	100% of table load per side. <b>See footnote 5.</b>	100% of table load
<b>Ordering</b>	Add <i>SK</i> , angle required, right ( <i>R</i> ) or left ( <i>L</i> ), and <b>square cut (SQ)</b> or <b>bevel cut (BV)</b> to product number. Ex. HLBH3595_SK45R_BV	Add <i>SL</i> , slope required, and up ( <i>U</i> ) or down ( <i>D</i> ), to product number. Ex. HLBH3595_SL30D	See Sloped Seat and Skewed. Ex. HLBH3595_SK45R_BV_SL30D	Add <i>SF</i> , angle required, and right ( <i>R</i> ) or left ( <i>L</i> ), to product number. Ex. HLBH3595_SF30L	Add <i>O.S.</i> , and right ( <i>R</i> ) or left ( <i>L</i> ), to product number. Ex. HLBH3595_OSL	Add <i>SA</i> , and saddle width required to product number. Ex. HLBH3595_SA=5-1/2"	Add <i>DA</i> , and angle required to product number. Ex. HLBH3595_DA30

- 1) Skewed hangers with skews greater than 15° may have all joist nailing on outside flange.
- 2) Sloped or sloped / skewed hangers with slopes greater than 15° may have additional joist nails.
- 3) Skewed hangers typically require a bevel cut however, a square cut option may be available as a custom when requested.
- 4) Sloped top flanges with slopes greater than 15° may have additional header nails.
- 5) Minimum header thickness shall be double the top flange (TF) dimension for 100% table load.

# PHM / PHXU Top Flange Hangers



Used to connect LVL, LSL, and PSL beams to headers in medium load conditions using standard nails.

**Materials:** See EWP Top Mount Hangers charts, pages 199-207.

**Finish:** Primer; PHXU – G90 galvanizing.

**Codes:** See page 12 for Code Reference Chart

**Patents:** U.S. Patent No. 6,463,711 B1 – PHXU

**Installation:**

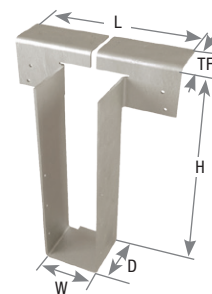
- Use all specified fasteners. See Product Notes, page 20.
- For welded installations, see page 287.

**Nailer Options**

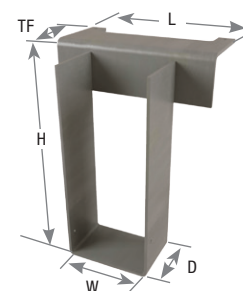
– chart represents maximum allowable loads for hangers used on wood nailers. Reference page 183.



**Typical PHXU installation**



**PHXU**



**PHM**

MiTek USP Series	Nailer Size	Fastener Schedule <sup>4</sup>				DF/SP		SPF	
		Nailer		Joist		Allowable Loads (Lbs.) <sup>1</sup>		Allowable Loads (Lbs.) <sup>1</sup>	
		Qty	Type	Qty	Type	100%	Uplift	100%	Uplift
PHM	2X	2	10d x 1-1/2	2	10d x 1-1/2	3010	--	2590	--
	3X	2	16d x 2-1/2	2	10d x 1-1/2	3570	--	3070	--
	(2) 2X	2	10d	2	10d x 1-1/2	3325	--	2860	--
	4X	2	16d	2	10d x 1-1/2	3255	--	2800	--
PHXU <sup>3</sup> widths > 2-3/4" to < 3-1/2"	2X	4	10d x 1-1/2	6	10d x 1-1/2	2585	--	2170	--
	3X	6	16d x 2-1/2	6	10d x 1-1/2	3855	--	3070	--
	(2) 2X	6	10d	6	10d x 1-1/2	3590	--	3015	--
	4X	8	16d	6	10d x 1-1/2	4420	<b>870</b>	3070	<b>730</b>
PHXU <sup>2</sup> widths ≥ 3-1/2"	2X	4	10d x 1-1/2	6	10d	2765	--	2325	--
	3X	6	16d x 2-1/2	6	10d	3895	--	3270	--
	(2) 2X	6	10d	6	10d	3785	--	3180	--
	4X	8	16d	6	10d x 1-1/2	5285	970	3590	835
	4X	8	16d	6	10d	5285	<b>1120</b>	3590	<b>940</b>

- 1) Listed loads shall not be increased.
- 2) Loads valid for hanger height ≤ 20". For hanger height ≥ 22", consult MiTek Engineering.
- 3) **PHXU hangers with a width of less than 2-3/4" are limited to 4,350 lbs of download.**
- 4) **NAILS:** 10d x 1-1/2 nails are 0.148" dia. x 1-1/2" long, 10d nails are 0.148" dia. x 3" long, 16d nails are 0.162" dia. x 3-1/2" long, 16d x 2-1/2 nails are 0.162" dia. x 2-1/2" long. New products or updated product information are designated in **blue font**.

**Specialty Options Chart**

– refer to Specialty Options pages 283, 285-286 for additional details.

Option	MiTek USP Series	Skewed <sup>1,3,5</sup>	Sloped Seat <sup>2,3</sup>	Sloped / Skewed <sup>1,2,3</sup>	Sloped Top Flange <sup>4</sup>	Top Flange Offset <sup>5,7</sup>	Saddle <sup>5,6</sup>	Ridge
Range	PHM PHXU	1° to 84° 1° to 60°	1° to 45°	See Sloped Seat and Skewed	0° to 35°	--	--	0° to 45° N/A
Allowable Loads	PHM PHXU	100% of table load	100% of table load	100% of table load up to Max. load of 2500 lbs. 100% of table load up to Max. load of 3900 lbs.	100% of table load	<b>% of table load</b> 3-1/2" or less 60% 3-9/16" to 5-1/2" 75% 5-9/16" to 7-1/2" 85%	100% of table load. <b>See footnote 6.</b>	100% of table load
Ordering	PHM PHXU	Add <i>SK</i> , angle required, right ( <i>R</i> ) or left ( <i>L</i> ), and square cut ( <i>SQ</i> ) or bevel cut ( <i>BI</i> ) to product number. Ex: PHXU1795_SK45R_SQ	Add <i>SL</i> , slope required, and up ( <i>U</i> ) or down ( <i>D</i> ), to product number. Ex: PHXU1795_SL30D	See Sloped Seat and Skewed. Ex: PHXU1795_SK45R_SQ_SL30D	Add <i>SF</i> , angle required, and right ( <i>R</i> ) or left ( <i>L</i> ), to product number. Ex: PHXU1795_SF30L	Add <i>OS</i> , and right ( <i>R</i> ) or left ( <i>L</i> ), to product number. Ex: PHXU1795_OSL	Add <i>SA</i> , and saddle width required to product number. Ex: PHXU1795_SA=5-1/2"	Add <i>DA</i> , and angle required to product number. Ex: PHXU1795_DA30 N/A

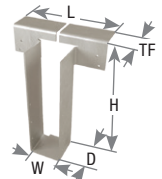
- 1) Skewed hangers with skews greater than 15° may have all joist nailing on outside flange.
- 2) Sloped or sloped/skewed hangers with slopes greater than 15° may have additional joist nails.
- 3) For skewed hangers, the required cut type (square or bevel) of joist member may vary based on skew angle and width of hanger. Some square cut hangers will require custom pricing due to welded back plate.
- 4) Sloped top flanges with slopes greater than 15° may have additional header nails.
- 5) Skewed, top flange offset, or saddle options will have a solid, welded top flange.
- 6) Minimum header thickness shall be double the top flange (TF) dimension for 100% table load.
- 7) PHXU offset option - hanger will be welded with a closed top angle, not formed.

Joist Size (in)	MiTek USP Stock No.	Ref. No.	Web Stiff Req'd	Ga	Dimensions (in)					Fastener Schedule <sup>5</sup>					Allowable Loads Header Type (Lbs.) <sup>1,3</sup>							Code Ref.
					W	H	D	L	TF	Header			Joist		Download 100%					Uplift <sup>2</sup>		
										Top Qty	Face Qty	Type	Qty	Type	LVL	PSL	LSL	SPF	I-Joist <sup>4</sup>		DF/SP	
1-1/2 x 9-1/4	TH015925	--	--	18	1-9/16	9-1/4	2	--	1-1/2	4	2	10d	2	10d x 1-1/2	1235	1235	1235	955	1005	1235	230	IBC, FL, LA
	BPH15925	--	x	12	1-9/16	9-1/4	2-3/8	--	1-1/2	4	6	16d	4	10d x 1-1/2	2830	2830	2830	2095	--	2825	850	
1-1/2 x 9-1/2	TH015950	--	--	18	1-1/2	9-1/2	2	--	1-1/2	4	2	10d	2	10d x 1-1/2	1235	1235	1235	955	1090	1235	230	
	BPH1595	BA1.56/9.5	x	12	1-9/16	9-1/2	2-3/8	--	1-1/2	4	6	16d	4	10d x 1-1/2	2830	2830	2830	2095	--	2825	850	
1-1/2 x 11-1/4	BPH15112	--	x	12	1-9/16	11-1/4	2-3/8	--	1-1/2	4	6	16d	4	10d x 1-1/2	2830	2830	2830	2095	--	2825	850	
1-1/2 x 11-7/8	TH015118	ITS1.56/11.88	--	18	1-1/2	11-7/8	2	--	1-9/16	4	2	10d	2	10d x 1-1/2	1235	1235	1235	955	1205	1235	230	
	BPH15118	BA1.56/11.88	x	12	1-9/16	11-7/8	2-3/8	--	1-1/2	4	6	16d	4	10d x 1-1/2	2830	2830	2830	2095	--	2825	850	
1-1/2 x 14	TH015140	--	--	16	1-9/16	14	2-3/8	--	1-1/2	4	6	10d	2	10d x 1-1/2	1235	1235	1235	950	1030	1235	230	
	BPH1514	--	x	12	1-9/16	14	2-3/8	--	1-1/2	4	6	16d	4	10d x 1-1/2	2830	2830	2830	2095	--	2825	850	
1-5/8 x 9-1/2	TH016950	--	--	18	1-11/16	9-1/2	2	--	1-1/2	4	2	10d	2	10d x 1-1/2	1235	1235	1235	955	1005	1235	230	
1-5/8 x 11-1/4	TH016112	--	--	16	1-11/16	11-1/4	2	--	1-1/2	4	2	10d	2	10d x 1-1/2	1235	1235	1235	955	1030	1235	230	
1-5/8 x 11-7/8	TH016118	--	--	16	1-11/16	11-7/8	2	--	1-1/2	4	2	10d	2	10d x 1-1/2	1235	1235	1235	955	1030	1235	230	
1-5/8 x 14	TH016140	--	--	16	1-11/16	14	3	--	1-3/4	4	6	10d	2	10d x 1-1/2	2370	2370	2370	2185	1030	2370	230	
1-3/4 x 7-1/4	PHXU17725	WP1.81 H=7.25	x	7	1-13/16	7-1/4	3-1/4	10	2-1/2	4	4	16d	6	10d x 1-1/2	4350	4350	4350	<b>3245</b>	--	4350	930	
1-3/4 x 9-1/4	BPH17925	BA1.81/9.25	x	12	1-13/16	9-1/4	2-3/8	--	1-11/16	4	6	16d	4	10d x 1-1/2	2970	2970	2970	2300	--	2970	850	
	PHM17925	WP1.81 H=9.25	x	7/10	1-13/16	9-1/4	2-1/2	7	3	2	--	16d	2	10d x 1-1/2	3335	3335	3335	2140	--	3060	--	
	PHXU17925	--	x	7	1-13/16	9-1/4	3-1/4	10	2-1/2	4	4	16d	6	10d x 1-1/2	4350	4350	4350	<b>3245</b>	--	4350	930	
1-3/4 x 9-1/2	TH017950	ITS1.81/9.5	--	18	1-3/4	9-1/2	2	--	1-1/2	4	2	10d	2	10d x 1-1/2	1235	1235	1235	950	1235	1235	230	
	BPH1795	BA1.81/9.5, MIT9.5	x	12	1-13/16	9-1/2	2-3/8	--	1-11/16	4	6	16d	4	10d x 1-1/2	2970	2970	2970	2300	--	2970	850	
	PHM1795	WP1.81 H=9.5	x	7/10	1-13/16	9-1/2	2-1/2	7	3	2	--	16d	2	10d x 1-1/2	3335	3335	3335	2140	--	3060	--	
	PHXU1795	--	x	7	1-13/16	9-1/2	3-1/4	10	2-1/2	4	4	16d	6	10d x 1-1/2	4350	4350	4350	<b>3245</b>	--	4350	930	
1-3/4 x 11-1/4	BPH17112	BA1.81/11.25	x	12	1-13/16	11-1/4	2-3/8	--	1-11/16	4	6	16d	4	10d x 1-1/2	2970	2970	2970	2300	--	2970	850	
	PHM17112	WP1.81 H=11.25	x	7/10	1-13/16	11-1/4	2-1/2	7	3	2	--	16d	2	10d x 1-1/2	3335	3335	3335	2140	--	3060	--	
	PHXU17112	--	x	7	1-13/16	11-1/4	3-1/4	10	2-1/2	4	4	16d	6	10d x 1-1/2	4350	4350	4350	<b>3245</b>	--	4350	930	
1-3/4 x 11-7/8	TH017118	ITS1.81/11.88, MIT11.88	--	18	1-3/4	11-7/8	2	--	1-9/16	4	2	10d	2	10d x 1-1/2	1235	1235	1235	950	1235	1235	230	
	BPH17118	BA1.81/11.88	x	12	1-13/16	11-7/8	2-3/8	--	1-11/16	4	6	16d	4	10d x 1-1/2	2970	2970	2970	2300	--	2970	850	
	PHM17118	WP1.81 H=11.875	x	7/10	1-13/16	11-7/8	2-1/2	7	3	2	--	16d	2	10d x 1-1/2	3335	3335	3335	2140	--	3060	--	
	PHXU17118	--	x	7	1-13/16	11-7/8	3-1/4	10	2-1/2	4	4	16d	6	10d x 1-1/2	4350	4350	4350	<b>3245</b>	--	4350	930	
1-3/4 x 14	TFL1714	ITS1.81/14	--	18	1-3/4	14	2	--	1-1/2	4	2	10d	2	10d x 1-1/2	1585	1585	1585	1260	1245	1585	130	
	BPH1714	BA1.81/14, MIT1.81/14	x	12	1-13/16	14	2-3/8	--	1-11/16	4	6	16d	4	10d x 1-1/2	2970	2970	2970	2300	--	2970	850	
	PHM1714	WP1.81 H=14	x	7/10	1-13/16	14	2-1/2	7	3	2	--	16d	2	10d x 1-1/2	3335	3335	3335	2140	--	3060	--	
	PHXU1714	--	x	7	1-13/16	14	3-1/4	10	2-1/2	4	4	16d	6	10d x 1-1/2	4350	4350	4350	<b>3245</b>	--	4350	930	
1-3/4 x 16	TFL1716	ITS1.81/16	--	18	1-3/4	16	2	--	1-1/2	4	2	10d	2	10d x 1-1/2	1585	1585	1585	1260	1245	1585	130	
	BPH1716	BA1.81/16, MIT1.81/16	x	12	1-13/16	16	2-3/8	--	1-11/16	4	6	16d	4	10d x 1-1/2	2970	2970	2970	2300	--	2970	850	
	PHM1716	WP1.81 H=16	x	7/10	1-13/16	16	2-1/2	7	3	2	--	16d	2	10d x 1-1/2	3335	3335	3335	2140	--	3060	--	
2 - 2-1/8 x 9-1/2	TFL2095	ITS2.06/9.5	--	18	2-1/8	9-1/2	2	--	1-1/2	4	2	10d	2	10d x 1-1/2	1585	1585	1585	1260	1245	1585	130	
2 - 2-1/8 x 11-7/8	TFL20118	ITS2.06/11.88	--	18	2-1/8	11-7/8	2	--	1-1/2	4	2	10d	2	10d x 1-1/2	1585	1585	1585	1260	1245	1585	130	
2 - 2-1/8 x 14	TFL2014	ITS2.06/14	--	18	2-1/8	14	2	--	1-1/2	4	2	10d	2	10d x 1-1/2	1585	1585	1585	1260	1245	1585	130	

1) When I-joist is used as a header, all nails must be 10d x 1-1/2.  
 2) Uplift loads have been increased 60% for wind or seismic loads; no further increase shall be permitted  
 3) Some listed loads may be increased for short-term loading. Refer to code evaluation reports for MiTek USA, Inc. for details.  
 4) When I-Joists with flanges less than 1-1/2" thick are used as headers, the reduction factor for 1-1/4" flange is 0.69 and 0.84 for 1-3/8" flange.  
 5) **NAILS:** 10d x 1-1/2 nails are 0.148" dia. x 1-1/2" long, 10d nails are 0.148" dia. x 3" long, 16d nails are 0.162" dia. x 3-1/2" long.  
**Load tables address hanger/header/fastener limitations only. Joist limitations must be determined for each installation.**  
 New products or updated product information are designated in **blue font**.

Copyright © 2019 MiTek Industries, Inc. All Rights Reserved

EWP Hangers



Joist Size (in)	MiTek USP Stock No.	Ref. No.	Web Stiff Reqd	Ga	Dimensions (in)					Fastener Schedule <sup>5</sup>				Allowable Loads Header Type (Lbs.) <sup>1,3</sup>							Code Ref.	
					W	H	D	L	TF	Header		Joist		Download 100%					Uplift <sup>2</sup>			
										Top Qty	Face Qty	Type	Qty	Type	LVL	PSL	LSL	SPF	DF I-Joist <sup>4</sup>	DF/SP 160%		DF/SP 160%
2 - 2-1/8 x 16	TFL2016	ITS2.06/16	--	18	2-1/8	16	2	--	1-1/2	4	2	10d	2	10d x 1-1/2	1585	1585	1585	1260	1245	1585	130	IBC, FL, LA
2-1/4 - 2-5/16 x 9-1/2	TFL2395	ITS2.37/9.5	--	18	2-5/16	9-1/2	2	--	1-1/2	4	2	10d	2	10d x 1-1/2	1585	1585	1585	1260	1245	1585	130	
2-1/4 - 2-5/16 x 11-7/8	TFL23118	ITS2.37/11.88	--	18	2-5/16	11-7/8	2	--	1-1/2	4	2	10d	2	10d x 1-1/2	1585	1585	1585	1260	1245	1585	130	IBC, FL, LA
2-1/4 - 2-5/16 x 14	TFL2314	ITS2.37/14	--	18	2-5/16	14	2	--	1-1/2	4	2	10d	2	10d x 1-1/2	1585	1585	1585	1260	1245	1585	130	
	THO23140	BA2.37/14	--	18	2-3/8	14	2-3/8	--	2	4	8	10d	2	10d x 1-1/2	2400	2400	2400	1840	2400	2400	230	
	TFI3514	MIT3514	--	16	2-3/8	14	2-1/2	--	2-1/16	4	2	16d	2	10d x 1-1/2	2715	2715	2715	2080	--	2715	215	
	PHM2314	WP2.37 H=14	x	7/10	2-3/8	14	2-1/2	7	3	2	--	16d	2	10d x 1-1/2	3335	3335	3335	2535	--	3335	--	
2-1/4 - 2-5/16 x 16	TFL2316	ITS2.37/16	--	18	2-5/16	16	2	--	1-1/2	4	2	10d	2	10d x 1-1/2	1585	1585	1585	1260	1245	1585	130	IBC, FL, LA
	TFI3516	MIT3516	--	16	2-3/8	16	2-1/2	--	2-1/16	4	2	16d	2	10d x 1-1/2	2715	2715	2715	2080	--	2715	215	
	PHM2316	WP2.37 H=16	x	7/10	2-3/8	16	2-1/2	7	3	2	--	16d	2	10d x 1-1/2	3335	3335	3335	2535	--	3335	--	
2-1/4 - 2-5/16 x 18	TFI3518	BA2.37/18, MIT3518	--	16	2-3/8	18	2-1/2	--	2-1/16	4	2	16d	2	10d x 1-1/2	2715	2715	2715	2080	--	2715	215	IBC, FL, LA
	PHM2318	WP2.37 H=18	x	7/10	2-3/8	18	2-1/2	7	3	2	--	16d	2	10d x 1-1/2	3335	3335	3335	2535	--	3335	--	
2-1/4 - 2-5/16 x 20	TFI3520	BA2.37/20, MIT3520	--	16	2-3/8	20	2-1/2	--	2-1/16	4	2	16d	2	10d x 1-1/2	2715	2715	2715	2080	--	2715	215	IBC, FL, LA
	PHM2320	WP2.37 H=20	x	7/10	2-3/8	20	2-1/2	7	3	2	--	16d	2	10d x 1-1/2	3335	3335	3335	2535	--	3335	--	
2-1/2 x 9-1/4	TFL25925	--	--	18	2-1/2	9-1/4	2	--	1-1/2	4	2	10d	2	10d x 1-1/2	1585	1585	1585	1260	1245	1585	130	IBC, FL, LA
2-1/2 x 9-3/8	TFL25938	--	--	18	2-1/2	9-3/8	2	--	1-1/2	4	2	10d	2	10d x 1-1/2	1585	1585	1585	1260	1245	1585	130	
2-1/2 x 9-1/2	TFL2595	ITS2.56/9.5	--	18	2-1/2	9-1/2	2	--	1-1/2	4	2	10d	2	10d x 1-1/2	1585	1585	1585	1260	1245	1585	130	IBC, FL, LA
2-1/2 x 11-1/4	TFL25112	--	--	18	2-1/2	11-1/4	2	--	1-1/2	4	2	10d	2	10d x 1-1/2	1585	1585	1585	1260	1245	1585	130	
2-1/2 x 11-7/8	TFL25118	ITS2.56/11.88	--	18	2-1/2	11-7/8	2	--	1-1/2	4	2	10d	2	10d x 1-1/2	1585	1585	1585	1260	1245	1585	130	IBC, FL, LA
	THO25118	MIT311.88	--	16	2-9/16	11-7/8	2-3/8	--	1-15/16	4	6	10d	2	10d x 1-1/2	2370	2370	2370	2095	1835	2370	230	
2-1/2 x 13	TFL2513	--	--	18	2-1/2	13	2	--	1-1/2	4	2	10d	2	10d x 1-1/2	1585	1585	1585	1260	1245	1585	130	IBC, FL, LA
2-1/2 x 14	TFL2514	ITS2.56/14	--	18	2-1/2	14	2	--	1-1/2	4	2	10d	2	10d x 1-1/2	1585	1585	1585	1260	1245	1585	130	
	THO25140	MIT314	--	18	2-9/16	14	2-3/8	--	2	4	8	10d	2	10d x 1-1/2	2400	2400	2400	1835	2400	2400	230	
	TFI314	--	--	16	2-9/16	14	2-1/2	--	2	4	2	16d	2	10d x 1-1/2	2715	2715	2715	2080	--	2715	215	
	PHM2514	WP2.56 H=14	--	7/10	2-9/16	14	2-1/2	7	3	2	--	16d	2	10d x 1-1/2	3335	3335	3335	2535	--	3335	--	
2-1/2 x 16	TFL2516	ITS2.56/16	--	18	2-1/2	16	2	--	1-1/2	4	2	10d	2	10d x 1-1/2	1585	1585	1585	1260	1245	1585	130	IBC, FL, LA
	TFI316	BA2.56/16, MIT316	--	16	2-9/16	16	2-1/2	--	2	4	2	16d	2	10d x 1-1/2	2715	2715	2715	2080	--	2715	215	
	PHM2516	WP2.56 H=16	--	7/10	2-9/16	16	2-1/2	7	3	2	--	16d	2	10d x 1-1/2	3335	3335	3335	2535	--	3335	--	
2-1/2 x 18	TFI318	HIT318, BA2.56/18, MIT318	--	16	2-9/16	18	2-1/2	--	2	4	2	16d	2	10d x 1-1/2	2715	2715	2715	2080	--	2715	215	IBC, FL, LA
2-1/2 x 20	TFI320	HIT320, BA2.56/20, MIT320	--	16	2-9/16	20	2-1/2	--	2	4	2	16d	2	10d x 1-1/2	2715	2715	2715	2080	--	2715	215	
2-1/2 x 22	TFI322	HIT322, BA2.56/22, WP2.56 H=22	--	16	2-9/16	22	2-1/2	--	2	4	6	16d	2	10d x 1-1/2	2820	2820	2820	2485	--	2820	215	
2-1/2 x 24	TFI324	HIT324, BA2.56/24, WP2.56 H=24	--	16	2-9/16	24	2-1/2	--	2	4	6	16d	2	10d x 1-1/2	2820	2820	2820	2485	--	2820	215	
2-1/2 x 26	TFI326	BA2.56/26, WP2.56 H=26	--	16	2-9/16	26	2-1/2	--	2	4	6	16d	2	10d x 1-1/2	2820	2820	2820	2485	--	2820	215	
2-5/8 x 9-1/2	THO26950	--	--	18	2-11/16	9-1/2	2-3/8	--	2	4	6	10d	2	10d x 1-1/2	2525	2525	2525	2070	1625	2525	230	IBC, FL, LA
2-5/8 x 11-7/8	THO26118	--	--	16	2-11/16	11-7/8	2-3/8	--	2	4	6	10d	2	10d x 1-1/2	2370	2370	2370	2115	1835	2370	230	
2-5/8 x 14	THO26140	--	--	18	2-11/16	14	2-3/8	--	2	4	8	10d	2	10d x 1-1/2	2400	2400	2400	1835	2400	2400	230	
2-5/8 x 16	THO26160	--	--	18	2-11/16	16	2-3/8	--	2	4	8	10d	2	10d x 1-1/2	2400	2400	2400	1835	2400	2400	230	

1) When I-joist is used as a header, all nails must be 10d x 1-1/2.

2) Uplift loads have been increased 60% for wind or seismic loads; no further increase shall be permitted

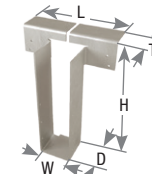
3) Some listed loads may be increased for short-term loading. Refer to code evaluation reports for MiTek USA, Inc. for details.

4) **When I-Joists with flanges less than 1-1/2" thick are used as headers, the reduction factor for 1-1/4" flange is 0.69 and 0.84 for 1-3/8" flange.**

5) **NAILS:** 10d x 1-1/2 nails are 0.148" dia. x 1-1/2" long, 10d nails are 0.148" dia. x 3" long, NA16D-RS nails are 0.148" x 3-1/2" long, 16d nails are 0.162" dia. x 3-1/2" long.

**Load tables address hanger/header/fastener limitations only. Joist limitations must be determined for each installation.**

New products or updated product information are designated in **blue font**.





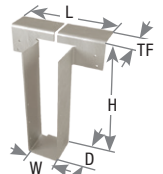
Joist Size (in)	MiTek USP Stock No.	Ref. No.	Web Stiff Req'd	Ga	Dimensions (in)					Fastener Schedule <sup>5</sup>					Allowable Loads Header Type (Lbs.) <sup>1,3</sup>							Uplift <sup>2</sup> 160%	e Ref.
					W	H	D	L	TF	Header		Joist			Download 100%								
										Top Qty	Face Qty	Type	Qty	Type	LVL	PSL	LSL	SPF	I-Joist <sup>4</sup>	DF/SP	DF/SP		
2-11/16 x 9-1/4	PHXU27925	--	--	7	2-3/4	9-1/4	3-1/4	10	2-1/2	4	4	16d	6	10d x 1-1/2	5370	5370	5370	<b>4120</b>	--	5370	870		
	HLBH27925	--	x	7	2-3/4	9-1/4	6	12	2-3/4	3	12	NA16D-RS	6	10d x 1-1/2	10045	10045	10045	6900	--	10045	1115		
2-11/16 x 9-1/2	PHXU2795	--	--	7	2-3/4	9-1/2	3-1/4	10	2-1/2	4	4	16d	6	10d x 1-1/2	5370	5370	5370	<b>4120</b>	--	5370	870		
	HLBH2795	--	x	7	2-3/4	9-1/2	6	12	2-3/4	3	12	NA16D-RS	6	10d x 1-1/2	10045	10045	10045	6900	--	10045	1115		
2-11/16 x 11-1/4	PHXU27112	--	--	7	2-3/4	11-1/4	3-1/4	10	2-1/2	4	4	16d	6	10d x 1-1/2	5370	5370	5370	<b>4120</b>	--	5370	870		
	HLBH27112	--	x	7	2-3/4	11-1/4	6	12	2-3/4	3	12	NA16D-RS	6	10d x 1-1/2	10045	10045	10045	6900	--	10045	1115		
2-11/16 x 11-7/8	PHXU27118	--	--	7	2-3/4	11-7/8	3-1/4	10	2-1/2	4	4	16d	6	10d x 1-1/2	5370	5370	5370	<b>4120</b>	--	5370	870		
	HLBH27118	--	x	7	2-3/4	11-7/8	6	12	2-3/4	3	12	NA16D-RS	6	10d x 1-1/2	10045	10045	10045	6900	--	10045	1115		
2-11/16 x 14	PHXU2714	--	--	7	2-3/4	14	3-1/4	10	2-1/2	4	4	16d	6	10d x 1-1/2	5370	5370	5370	<b>4120</b>	--	5370	870		
	HLBH2714	--	x	7	2-3/4	14	6	12	2-3/4	3	12	NA16D-RS	6	10d x 1-1/2	10045	10045	10045	6900	--	10045	1115		
2-11/16 x 16	PHXU2716	--	--	7	2-3/4	16	3-1/4	10	2-1/2	4	4	16d	6	10d x 1-1/2	5370	5370	5370	<b>4120</b>	--	5370	870		
	HLBH2716	--	x	7	2-3/4	16	6	12	2-3/4	3	12	NA16D-RS	6	10d x 1-1/2	10045	10045	10045	6900	--	10045	1115		
3 x 9-1/4	BPH31925	--	x	12	3-1/8	9-1/4	3	--	<b>2-1/8</b>	4	6	16d	4	10d	3055	3055	3055	2345	--	3055	850		
	PHXU31925	--	x	7	3-1/8	9-1/4	3-1/4	10	2-1/2	4	4	16d	6	10d x 1-1/2	5370	5370	5370	<b>4120</b>	--	5370	870		
3 x 9-1/2	THO15950-2	--	x	16	3-1/16	9-1/2	2-3/8	--	1-1/2	4	6	16d	6	10d	2525	2525	2525	1905	2525	2525	1135		
	BPH3195	--	x	12	3-1/8	9-1/2	3	--	<b>2-7/16</b>	4	6	16d	4	10d	3055	3055	3055	2345	--	3055	850		
	PHXU3195	--	x	7	3-1/8	9-1/2	3-1/4	10	2-1/2	4	4	16d	6	10d x 1-1/2	5370	5370	5370	<b>4120</b>	--	5370	870		
3 x 11-1/4	BPH31112	--	x	12	3-1/8	11-1/4	3	--	<b>2-1/8</b>	4	6	16d	4	10d	3055	3055	3055	2345	--	3055	850		
	PHXU31112	--	x	7	3-1/8	11-1/4	3-1/4	10	2-1/2	4	4	16d	6	10d x 1-1/2	5370	5370	5370	<b>4120</b>	--	5370	870		
3 x 11-7/8	THO15118-2	--	x	16	3-1/16	11-7/8	2-3/8	--	1-1/2	4	6	16d	6	10d	2525	2525	2525	1890	2525	2525	1135		
	BPH31118	--	x	12	3-1/8	11-7/8	3	--	<b>2-1/8</b>	4	6	16d	4	10d	3055	3055	3055	2345	--	3055	850		
	PHXU31118	--	x	7	3-1/8	11-7/8	3-1/4	10	2-1/2	4	4	16d	6	10d x 1-1/2	5370	5370	5370	<b>4120</b>	--	5370	870		
3 x 14	BPH3114	--	x	12	3-1/8	14	3	--	2-3/32	4	6	16d	4	10d	3055	3055	3055	2345	--	3055	850		
	PHXU3114	--	x	7	3-1/8	14	3-1/4	10	2-1/2	4	4	16d	6	10d x 1-1/2	5370	5370	5370	<b>4120</b>	--	5370	870		
3-1/2 x 7-1/4	PHXU35725	--	x	7	3-9/16	7-1/4	3-1/4	10	2-1/2	4	4	16d	6	10d	5910	5910	5910	<b>4535</b>	--	5910	1120		
3-1/2 x 9-1/4	THO35925	ITS3.56/9.25	--	16	3-9/16	9-1/4	2-3/8	--	2-1/2	4	6	10d	2	10d x 1-1/2	2370	2370	2370	2370	2050	2370	230		
	BPH35925	BA3.56/9.25	x	12	3-9/16	9-1/4	2-3/8	--	2-3/8	4	6	16d	4	10d	3100	3100	3100	2380	--	3100	850		
	HBPH35925	HB3.56/9.25	x	10	3-9/16	9-1/4	3-1/2	--	3	6	16	16d	10	16d	6310	6310	6310	5035	--	6310	2705		
	PHM35925	WP3.56 H=9.25	x	7/10	3-5/8	9-1/4	2-1/2	7	3	2	--	16d	2	10d	3335	3335	3335	2535	--	3335	--		
	PHXU35925	HWP3.56 H=9.25	x	7	3-9/16	9-1/4	3-1/4	10	2-1/2	4	4	16d	6	10d	5910	5910	5910	<b>4535</b>	--	5910	1120		
	HLBH35925	HGLTV3.56/9.25	x	7	3-5/8	9-1/4	6	12	3-1/8	3	12	NA16D-RS	6	16d	10045	10045	10045	7705	--	10045	1420		
3-1/2 x 9-3/8	THO35938	--	--	16	3-9/16	9-3/8	2-3/8	--	2-9/16	4	6	10d	2	10d x 1-1/2	2370	2370	2370	2215	2050	2370	230		
3-1/2 x 9-1/2	THO35950	ITS3.56/9.5	--	16	3-9/16	9-1/2	2-3/8	--	2-7/16	4	6	10d	2	10d x 1-1/2	2370	2370	2370	2370	2050	2370	230		
	THO17950-2	MIT49.5	x	16	3-9/16	9-1/2	2-3/8	--	1-9/16	4	6	16d	6	10d	2920	2920	2920	1955	2630	2630	1135		
	BPH3595	BA3.56/9.5	x	12	3-9/16	9-1/2	2-3/8	--	2-3/8	4	6	16d	4	10d	3100	3100	3100	2380	--	3100	850		
	HBPH3595	HB3.56/9.5	x	10	3-9/16	9-1/2	3-1/2	--	3	6	16	16d	10	16d	6310	6310	6310	5035	--	6310	2705		
	PHM3595	WP3.56 H=9.5	x	7/10	3-5/8	9-1/2	2-1/2	7	3	2	--	16d	2	10d	3335	3335	3335	2535	--	3335	--		
	PHXU3595	HWP3.56 H=9.5	x	7	3-9/16	9-1/2	3-1/4	10	2-1/2	4	4	16d	6	10d	5910	5910	5910	<b>4535</b>	--	5910	1120		
	HLBH3595	HGLTV3.59	x	7	3-5/8	9-1/2	6	12	3-1/8	3	12	NA16D-RS	6	16d	10045	10045	10045	7705	--	10045	1420		

IBC, FL, LA

EWP Hangers

Copyright © 2019 MiTek Industries, Inc. All Rights Reserved

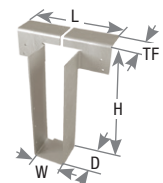
1) When I-joist is used as a header, all nails must be 10d x 1-1/2.  
 2) Uplift loads have been increased 60% for wind or seismic loads; no further increase shall be permitted.  
 3) Some listed loads may be increased for short-term loading. Refer to code evaluation reports for MiTek USA, Inc. for details.  
 4) **When I-Joists with flanges less than 1-1/2" thick are used as headers, the reduction factor for 1-1/4" flange is 0.69 and 0.84 for 1-3/8" flange.**  
 5) **NAILS:** 10d x 1-1/2 nails are 0.148" dia. x 1-1/2" long, 10d nails are 0.148" dia. x 3" long, NA16D-RS nails are 0.148" x 3-1/2" long, 16d nails are 0.162" dia. x 3-1/2" long.  
**Load tables address hanger/header/fastener limitations only. Joist limitations must be determined for each installation.**  
 New products or updated product information are designated in **blue font**.



Joist Size (in)	MiTek USP Stock No.	Ref. No.	Web Stiff Req'd	Ga	Dimensions (in)					Fastener Schedule <sup>5</sup>					Allowable Loads Header Type (Lbs.) <sup>1,3</sup>							Code Ref.
					W	H	D	L	TF	Header		Joist			Download 100%					Uplift <sup>2</sup> 160%		
										Top Qty	Face Qty	Type	Qty	Type	LVL	PSL	LSL	SPF	DF I-Joist <sup>4</sup>		DF/SP	
3-1/2 x 11-1/4	TH035112	--	--	16	3-9/16	11-1/4	2-3/8	--	2-1/2	4	6	10d	2	10d x 1-1/2	2370	2370	2370	2370	2050	2370	230	
	BPH35112	BA3.56/11.25	x	12	3-9/16	11-1/4	2-3/8	--	2-3/8	4	6	16d	4	10d	3100	3100	3100	2380	--	3100	850	
	HBPH35112	HB3.56/11.25	x	10	3-9/16	11-1/4	3-1/2	--	3	6	16	16d	10	16d	6310	6310	6310	5035	--	6310	2705	
	PHXU35112	WP3.56 H=11.25, HWP3.56 H=11.25	x	7	3-9/16	11-1/4	3-1/4	10	2-1/2	4	4	16d	6	10d	5910	5910	5910	<b>4535</b>	--	5910	1120	
	HLBH35112	HGLTV3.56/11.25	x	7	3-5/8	11-1/4	6	12	3-1/8	3	12	NA16D-RS	6	16d	10045	10045	10045	7705	--	10045	1420	
3-1/2 x 11-7/8	TH035118	ITS3.56/11.88	--	18	3-9/16	11-7/8	2-3/8	--	2-1/2	4	6	10d	2	10d x 1-1/2	2525	2525	2525	2265	2050	2525	230	
	TH017118-2	MIT411.88	x	16	3-9/16	11-7/8	2-3/8	--	1-9/16	4	6	16d	6	10d	2740	2860	2920	1815	2430	2430	1135	
	BPH35118	BA3.56/11.88	x	12	3-9/16	11-7/8	2-3/8	--	2-3/8	4	6	16d	4	10d	3100	3100	3100	2380	--	3100	850	
	HBPH35118	HB3.56/11.88	x	10	3-9/16	11-7/8	3-1/2	--	3	6	16	16d	10	16d	6310	6310	6310	5035	--	6310	2705	
	PHM35118	WP3.56 H=11.875	x	7/10	3-5/8	11-7/8	2-1/2	7	3	2	--	16d	2	10d	3335	3335	3335	2535	--	3335	--	
	PHXU35118	HWP3.56 H=11.875, HWP3.56 H=11.875	x	7	3-9/16	11-7/8	3-1/4	10	2-1/2	4	4	16d	6	10d	5910	5910	5910	<b>4535</b>	--	5910	1120	
HLBH35118	HGLT4 H=11.875, HGLTV3.511	x	7	3-5/8	11-7/8	6	12	3-1/8	3	12	NA16D-RS	6	16d	10045	10045	10045	7705	--	10045	1420		
3-1/2 x 12	TH035120	--	--	18	3-9/16	12	2-3/8	--	2-1/2	4	6	10d	2	10d x 1-1/2	2525	2525	2525	2265	2050	2525	230	
	BPH3512	--	x	12	3-9/16	12	2-3/4	--	3	4	6	16d	6	10d	3050	3050	3050	2345	--	3050	1140	
	HBPH3512	HB3.56/12	x	10	3-9/16	12	3-1/2	--	3	6	16	16d	10	16d	6310	6310	6310	5035	--	6310	2705	
	PHXU3512	--	x	7	3-9/16	12	3-1/4	10	2-1/2	4	4	16d	6	10d	5910	5910	5910	<b>4535</b>	--	5910	1120	
	HLBH3512	HGLTV3.512	x	7	3-5/8	12	6	12	3-1/8	3	12	NA16D-RS	6	16d	10045	10045	10045	7705	--	10045	1420	
3-1/2 x 13	TH035130	--	--	18	3-9/16	13	2-3/8	--	2-1/2	4	6	10d	2	10d x 1-1/2	2525	2525	2525	2265	2050	2525	230	
3-1/2 x 14	TH035140	ITS3.56/14	--	18	3-9/16	14	2-3/8	--	2-1/2	4	8	10d	2	10d x 1-1/2	2400	2400	2400	1835	2400	2400	230	
	TFI414	MIT414	--	16	3-9/16	14	2-1/2	--	2-1/8	4	2	16d	2	10d x 1-1/2	2715	2715	2715	2075	--	2715	215	IBC, FL, LA
	BPH3514	BA3.56/14	x	12	3-9/16	14	2-3/4	--	3	4	6	16d	6	10d	3050	3050	3050	2345	--	3050	1140	
	HBPH3514	HB3.56/14	x	10	3-9/16	14	3-1/2	--	3	6	16	16d	10	16d	6310	6310	6310	5035	--	6310	2705	
	PHM3514	WP3.56 H=14	x	7/10	3-5/8	14	2-1/2	7	3	2	--	16d	2	10d	3335	3335	3335	2535	--	3335	--	
	PHXU3514	HWP3.56 H=14, HWP3.56 H=14	x	7	3-9/16	14	3-1/4	10	2-1/2	4	4	16d	6	10d	5910	5910	5910	<b>4535</b>	--	5910	1120	
HLBH3514	HGLT4 H=14, HGLTV3.514	x	7	3-5/8	14	6	12	3-1/8	3	12	NA16D-RS	6	16d	10045	10045	10045	7705	--	10045	1420		
3-1/2 x 16	TH035160	ITS3.56/16	--	18	3-9/16	16	2-3/8	--	2-1/2	4	8	10d	2	10d x 1-1/2	2400	2400	2400	1835	2400	2400	230	
	TFI416	MIT416	--	16	3-9/16	16	2-1/2	--	2-1/8	4	2	16d	2	10d x 1-1/2	2715	2715	2715	2075	--	2715	215	
	BPH3516	BA3.56/16	x	12	3-9/16	16	2-3/4	--	3	4	6	16d	6	10d	3050	3050	3050	2345	--	3050	1140	
	HBPH3516	HB3.56/16	x	10	3-9/16	16	3-1/2	--	3	6	16	16d	10	16d	6310	6310	6310	5035	--	6310	2705	
	PHM3516	WP3.56 H=16	x	7/10	3-5/8	16	2-1/2	7	3	2	--	16d	2	10d	3335	3335	3335	2535	--	3335	--	
	PHXU3516	HWP3.56 H=16, HWP3.56 H=16	x	7	3-9/16	16	3-1/4	10	2-1/2	4	4	16d	6	10d	5910	5910	5910	<b>4535</b>	--	5910	1120	
	HLBH3516	HGLT4 H=16, HGLTV3.516	x	7	3-5/8	16	6	12	3-1/8	3	12	NA16D-RS	6	16d	10045	10045	10045	7705	--	10045	1420	
3-1/2 x 18	TFI418	HIT418, MIT418	--	16	3-9/16	18	2-1/2	--	2-1/8	4	2	16d	2	10d x 1-1/2	2715	2715	2715	2075	--	2715	215	
	BPH3518	BA3.56/18	x	12	3-9/16	18	2-3/4	--	3	4	6	16d	6	10d	3050	3050	3050	2345	--	3050	1140	
	HBPH3518	HB3.56/18	x	10	3-9/16	18	3-1/2	--	3	6	16	16d	10	16d	6310	6310	6310	5035	--	6310	2705	
	PHM3518	WP3.56 H=18	x	7/10	3-5/8	18	2-1/2	7	3	2	--	16d	2	10d	3335	3335	3335	2535	--	3335	--	
	PHXU3518	HWP3.56 H=18, HWP3.56 H=18	x	7	3-9/16	18	3-1/4	10	2-1/2	4	4	16d	6	10d	5910	5910	5910	<b>4535</b>	--	5910	1120	
	HLBH3518	HGLT4 H=18, HGLTV3.518	x	7	3-5/8	18	6	12	3-1/8	3	12	NA16D-RS	6	16d	10045	10045	10045	7705	--	10045	1420	

1) When I-joist is used as a header, all nails must be 10d x 1-1/2.  
 2) Uplift loads have been increased 60% for wind or seismic loads; no further increase shall be permitted.  
 3) Some listed loads may be increased for short-term loading. Refer to code evaluation reports for MiTek USA, Inc. for details.  
 4) **When I-Joists with flanges less than 1-1/2" thick are used as headers, the reduction factor for 1-1/4" flange is 0.69 and 0.84 for 1-3/8" flange.**  
 5) **NAILS:** 10d x 1-1/2 nails are 0.148" dia. x 1-1/2" long, 10d nails are 0.148" dia. x 3" long, NA16D-RS nails are 0.148" x 3-1/2" long, 16d nails are 0.162" dia. x 3-1/2" long.  
**Load tables address hanger/header/fastener limitations only. Joist limitations must be determined for each installation.**  
 New products or updated product information are designated in **blue font**.

Copyright © 2019 MiTek Industries, Inc. All Rights Reserved

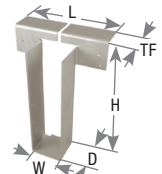


Joist Size (in)	MiTek USP Stock No.	Ref. No.	Web Stiff Req'd	Ga	Dimensions (in)					Fastener Schedule <sup>5</sup>					Allowable Loads Header Type (Lbs.) <sup>1,3</sup>							Code Ref.
					W	H	D	L	TF	Header			Joist		Download 100%					Uplift <sup>2</sup>		
										Top Qty	Face Qty	Type	Qty	Type	LVL	PSL	LSL	SPF	DF I-Joist <sup>4</sup>		DF/SP	
3-1/2 x 20	TFI420	HIT420, MIT420	--	16	3-9/16	20	2-1/2	--	2-1/8	4	2	16d	2	10d x 1-1/2	2715	2715	2715	2075	--	2715	215	IBC, FL, LA
	BPH3520	BA3.56/20	x	12	3-9/16	20	2-3/4	--	3	4	6	16d	6	10d	3050	3050	3050	2345	--	3050	1140	
	HBPH3520	HB3.56/20	x	10	3-9/16	20	3-1/2	--	3	6	16	16d	10	16d	6310	6310	6310	5035	--	6310	2705	
	PHM3520	WP3.56 H=20	x	7/10	3-5/8	20	2-1/2	7	3	2	--	16d	2	10d	3335	3335	3335	2535	--	3335	--	
	PHXU3520	HWP3.56 H=20, HWP3.56 H=20	x	7	3-9/16	20	3-1/4	10	2-1/2	4	4	16d	6	10d	5910	5910	5910	<b>4535</b>	--	5910	1120	
	HLBH3520	HGLT4 H=20	x	7	3-5/8	20	6	12	3-1/8	3	12	NA16D-RS	6	16d	10045	10045	10045	7705	--	10045	1420	
3-1/2 x 22	TFI422	HIT422	--	16	3-9/16	22	2-1/2	--	2-1/8	4	6	16d	2	10d x 1-1/2	2820	2820	2820	2480	--	2820	215	
	BPH3522	BA3.56/22	x	12	3-9/16	22	2-3/4	--	3	4	6	16d	6	10d	3050	3050	3050	2345	--	3050	1140	
	HBPH3522	HB3.56/22	x	10	3-9/16	22	3-1/2	--	3	6	16	16d	10	16d	6310	6310	6310	5035	--	6310	2705	
	PHM3522	WP3.56 H=22	x	7/10	3-5/8	22	2-1/2	7	3	2	--	16d	2	10d	3335	3335	3335	2535	--	3335	--	
	PHXU3522	HWP3.56 H=22, HWP3.56 H=22	x	7	3-9/16	22	3-1/4	10	2-1/2	4	4	16d	6	10d	5910	5910	5910	<b>4535</b>	--	5910	1120	
3-1/2 x 24	TFI424	HIT424	--	16	3-9/16	24	2-1/2	--	2-1/8	4	6	16d	2	10d x 1-1/2	2820	2820	2820	2480	--	2820	215	
	BPH3524	BA3.56/24	x	12	3-9/16	24	2-3/4	--	3	4	6	16d	6	10d	3050	3050	3050	2345	--	3050	1140	
	HBPH3524	HB3.56/24	x	10	3-9/16	24	3-1/2	--	3	6	16	16d	10	16d	6310	6310	6310	5035	--	6310	2705	
	PHM3524	WP3.56 H=24	x	7/10	3-5/8	24	2-1/2	7	3	2	--	16d	2	10d	3335	3335	3335	2535	--	3335	--	
	PHXU3524	HWP3.56 H=24, HWP3.56 H=24	x	7	3-9/16	24	3-1/4	10	2-1/2	4	4	16d	6	10d	5910	5910	5910	<b>4535</b>	--	5910	1120	
3-1/2 x 26	TFI426	--	--	16	3-9/16	26	2-1/2	--	2-1/8	4	6	16d	2	10d x 1-1/2	2820	2820	2820	2480	--	2820	215	
	BPH3526	BA3.56/26	x	12	3-9/16	26	2-3/4	--	3	4	6	16d	6	10d	3050	3050	3050	2345	--	3050	1140	
	HBPH3526	HB3.56/26	x	10	3-9/16	26	3-1/2	--	3	6	16	16d	10	16d	6310	6310	6310	5035	--	6310	2705	
	PHM3526	WP3.56 H=26	x	7/10	3-5/8	26	2-1/2	7	3	2	--	16d	2	10d	3335	3335	3335	2535	--	3335	--	
	PHXU3526	HWP3.56 H=26, HWP3.56 H=26	x	7	3-9/16	26	3-1/4	10	2-1/2	4	4	16d	6	10d	5910	5910	5910	<b>4535</b>	--	5910	1120	
3-1/2 x 28	BPH3528	BA3.56/28	x	12	3-9/16	28	2-3/4	--	3	4	6	16d	6	10d	3050	3050	3050	2345	--	3050	1140	
	HBPH3528	HB3.56/28	x	10	3-9/16	28	3-1/2	--	3	6	16	16d	10	16d	6310	6310	6310	5035	--	6310	2705	
	PHM3528	WP3.56 H=28	x	7/10	3-5/8	28	2-1/2	7	3	2	--	16d	2	10d	3335	3335	3335	2535	--	3335	--	
	PHXU3528	HWP3.56 H=28, HWP3.56 H=28	x	7	3-9/16	28	3-1/4	10	2-1/2	4	4	16d	6	10d	5910	5910	5910	<b>4535</b>	--	5910	1120	
3-1/2 x 30	BPH3530	BA3.56/30	x	12	3-9/16	30	2-3/4	--	3	4	6	16d	6	10d	3050	3050	3050	2345	--	3050	1140	
	HBPH3530	HB3.56/30	x	10	3-9/16	30	3-1/2	--	3	6	16	16d	10	16d	6310	6310	6310	5035	--	6310	2705	
	PHM3530	WP3.56 H=30	x	7/10	3-5/8	30	2-1/2	7	3	2	--	16d	2	10d	3335	3335	3335	2535	--	3335	--	
	PHXU3530	HWP3.56 H=30, HWP3.56 H=30	x	7	3-9/16	30	3-1/4	10	2-1/2	4	4	16d	6	10d	5910	5910	5910	<b>4535</b>	--	5910	1120	
3-1/2 x 32	BPH3532	--	x	12	3-9/16	32	2-3/4	--	3	4	6	16d	6	10d	3050	3050	3050	2345	--	3050	1140	
	PHM3532	--	x	7/10	3-5/8	32	2-1/2	7	3	2	--	16d	2	10d	3335	3335	3335	2535	--	3335	--	
	PHXU3532	--	x	7	3-9/16	32	3-1/4	10	2-1/2	4	4	16d	6	10d	5910	5910	5910	<b>4535</b>	--	5910	1120	
4 - 4-3/16 x 9-1/2	THO20950-2	MIT4.12/9.5, BA4.12/9.5	x	16	4-3/16	9-1/2	3	--	2	4	6	16d	6	10d	2920	2920	2920	2245	2630	2920	1135	
	PHM4295	WP4.12 H=9.5	x	7/10	4-3/16	9-1/2	2-1/2	7	3	2	--	16d	2	10d	3265	3265	3265	2480	--	3265	--	
4 - 4-3/16 x 11-7/8	THO20118-2	MIT4.12/11.88, BA4.12/11.88	x	16	4-3/16	11-7/8	3	--	2	4	6	16d	6	10d	2920	2920	2920	2245	2630	2920	1135	
	PHM42118	WP4.12 H=11.875	x	7/10	4-3/16	11-7/8	2-1/2	7	3	2	--	16d	2	10d	3265	3265	3265	2480	--	3265	--	
4 - 4-3/16 x 14	THO20140-2	BA4.12/14	x	12	4-3/16	14	3	--	1-15/16	4	6	16d	6	10d	3640	3640	3640	2800	2630	3640	1145	
	PHM4214	WP4.12 H=14	x	7/10	4-3/16	14	2-1/2	7	3	2	--	16d	2	10d	3265	3265	3265	2480	--	3265	--	

Copyright © 2019 MiTek Industries, Inc. All Rights Reserved

EWP Hangers

- When I-joist is used as a header, all nails must be 10d x 1-1/2.
  - Uplift loads have been increased 60% for wind or seismic loads; no further increase shall be permitted
  - Some listed loads may be increased for short-term loading. Refer to code evaluation reports for MiTek USA, Inc. for details.
  - When I-Joists with flanges less than 1-1/2" thick are used as headers, the reduction factor for 1-1/4" flange is 0.69 and 0.84 for 1-3/8" flange.
  - NAILS:** 10d x 1-1/2 nails are .148" dia. x 1-1/2" long, 10d nails are .148" dia. x 3" long, 16d nails are .162" dia. x 3-1/2" long.
- Load tables address hanger/header/fastener limitations only. Joist limitations must be determined for each installation.**  
New products or updated product information are designated in **blue font**.



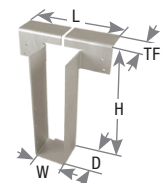
# Top Mount Hanger Charts

Joist Size (in)	MiTek USP Stock No.	Ref. No.	Web Stiff Req'd	Ga	Dimensions (in)					Fastener Schedule <sup>5</sup>					Allowable Loads Header Type (Lbs.) <sup>1,3</sup>							Code Ref.	
					W	H	D	L	TF	Header			Joist		Download 100%								Uplift <sup>2</sup>
										Top Qty	Face Qty	Type	Qty	Type	LVL	PSL	LSL	SPF	DF I-Joist <sup>4</sup>	DF/SP	DF/SP 160%		
4 - 4-3/16 x 16	THO20160-2	BA4.12/16	x	12	4-3/16	16	3	--	1-15/16	4	6	16d	6	10d	3640	3640	3640	2800	2630	3640	1145	IBC, FL, LA	
	PHM4216	WP4.12 H=16	x	7/10	4-3/16	16	2-1/2	7	3	2	--	16d	2	10d	3265	3265	3265	2480	--	3265	--		
4-1/2 - 4-5/8 x 9-1/2	THO23950-2	MIT4.28/9.5, BA4.28/9.5	x	12	4-3/4	9-1/2	3	--	2	4	6	16d	6	10d	3640	3640	3640	2790	2630	3640	1145		
	PHM2395-2	WP4.28X H=9.5	x	7/10	4-3/4	9-1/2	2-1/2	7	3	2	--	16d	2	10d	3265	3265	3265	2480	--	3265	--		
4-1/2 - 4-5/8 x 11-7/8	THO23118-2	MIT4.28/11.88, BA4.28/11.88	x	12	4-3/4	11-7/8	3	--	2-1/8	4	6	16d	6	10d	3640	3640	3640	2795	2630	3640	1145		
	PHM23118-2	WP4.28X H=11.875	x	7/10	4-3/4	11-7/8	2-1/2	7	3	2	--	16d	2	10d	3265	3265	3265	2480	--	3265	--		
4-1/2 - 4-5/8 x 14	THO23140-2	MIT4.28/14, BA4.28/14	x	12	4-3/4	14	3	--	2-1/8	4	8	16d	6	10d	4420	4420	4420	3390	2630	4420	1145		
4-1/2 - 4-5/8 x 16	THO23160-2	BA4.28/16	x	12	4-3/4	16	3	--	2-1/8	4	8	16d	6	10d	4420	4420	4420	3390	2630	4420	1145		
	PHM2316-2	WP4.28X H=16	x	7/10	4-3/4	16	2-1/2	7	3	2	--	16d	2	10d	3265	3265	3265	2480	--	3265	--		
4-1/2 - 4-5/8 x 18	THO23180-2	BA4.75/18	x	12	4-3/4	18	3	--	2-1/8	4	10	16d	6	10d	5660	5760	5760	3720	2630	5000	1145		
	PHM2318-2	WP4.75 H=18	x	7/10	4-3/4	18	2-1/2	7	3	2	--	16d	2	10d	3265	3265	3265	2480	--	3265	--		
4-1/2 - 4-5/8 x 20	THO23200-2	BA4.75/20	x	12	4-3/4	20	3	--	2-1/8	4	10	16d	6	10d	5660	5760	5760	3720	2630	5000	1145		
	PHM2320-2	WP4.75 H=20	x	7/10	4-3/4	20	2-1/2	7	3	2	--	16d	2	10d	3265	3265	3265	2480	--	3265	--		
5 x 9-1/4	THO25925-2	BA5.12/9.25	x	12	5-1/8	9-1/4	3	--	2-11/16	4	6	16d	6	10d	3640	3640	3640	2790	2630	3640	1145		
5 x 9-1/2	THO25950-2	MIT39.5-2	x	12	5-1/8	9-1/2	3	--	2-1/8	4	6	16d	6	10d	3640	3640	3640	2790	2630	3640	1145		
	PHM2595-2	WP5.12 H=9.5	x	7/10	5-1/8	9-1/2	2-1/2	7	3	2	--	16d	2	10d	3265	3265	3265	2480	--	3265	--		
5 x 11-1/4	THO25112-2	--	x	12	5-1/8	11-1/4	3	--	2-1/8	4	6	16d	6	10d	3640	3640	3640	2790	2630	3640	1145		
5 x 11-7/8	THO25118-2	MIT311.88-2, BA5.12/11.88, WP5.12 H=11.875	x	12	5-1/8	11-7/8	3	--	2-1/8	4	6	16d	6	10d	3640	3640	3640	2790	2630	3640	1145		
5 x 14	THO25140-2	MIT314-2, BA5.12/14	x	12	5-1/8	14	3	--	2-1/8	4	8	16d	6	10d	4420	4420	4420	3390	2630	4420	1145		
	PHM2514-2	WP5.12 H=14	x	7/10	5-1/8	14	2-1/2	7	3	2	--	16d	2	10d	3265	3265	3265	2480	--	3265	--		
5 x 16	THO25160-2	MIT5.12/16, BA5.12/16	x	12	5-1/8	16	3	--	2-1/8	4	8	16d	6	10d	4420	4420	4420	3390	2630	4420	1145		
	HBPH5116	HB5.12/16	x	10	5-1/8	16	3-1/2	--	3	6	16	16d	10	16d	6235	6235	6235	4950	--	6235	2705		
	PHM2516-2	WP5.12 H=16	x	7/10	5-1/8	16	2-1/2	7	3	2	--	16d	2	10d	3265	3265	3265	2480	--	3265	--		
5 x 18	THO25180-2	BA5.12/18	x	12	5-1/8	18	3	--	2-1/8	4	10	16d	6	10d	5660	5760	5760	3720	2630	5000	1145		
	HBPH5118	HB5.12/18	x	10	5-1/8	18	3-1/2	--	3	6	16	16d	10	16d	6235	6235	6235	4950	--	6235	2705		
	PHM2518-2	WP5.12 H=18	x	7/10	5-1/8	18	2-1/2	7	3	2	--	16d	2	10d	3265	3265	3265	2480	--	3265	--		
5 x 20	THO25200-2	BA5.12/20	x	12	5-1/8	20	3	--	2-1/8	4	10	16d	6	10d	5660	5760	5760	3720	2630	5000	1145		
	HBPH5120	HB5.12/20	x	10	5-1/8	20	3-1/2	--	3	6	16	16d	10	16d	6235	6235	6235	4950	--	6235	2705		
	PHM2520-2	WP5.12 H=20	x	7/10	5-1/8	20	2-1/2	7	3	2	--	16d	2	10d	3265	3265	3265	2480	--	3265	--		
5 x 22	HBPH5122	HB5.12/22	x	10	5-1/8	22	3-1/2	--	3	6	16	16d	10	16d	6235	6235	6235	4950	--	6235	2705		
	PHM2522-2	WP5.12 H=22	x	7/10	5-1/8	22	2-1/2	7	3	2	--	16d	2	10d	3265	3265	3265	2480	--	3265	--		
5 x 24	HBPH5124	HB5.12/24	x	10	5-1/8	24	3-1/2	--	3	6	16	16d	10	16d	6235	6235	6235	4950	--	6235	2705		
	PHM2524-2	WP5.12X H=24	x	7/10	5-1/8	24	2-1/2	7	3	2	--	16d	2	10d	3265	3265	3265	2480	--	3265	--		
5 x 26	HBPH5126	HB5.12/26	x	10	5-1/8	26	3-1/2	--	3	6	16	16d	10	16d	6235	6235	6235	4950	--	6235	2705		
5 x 28	HBPH5128	HB5.12/28	x	10	5-1/8	28	3-1/2	--	3	6	16	16d	10	16d	6235	6235	6235	4950	--	6235	2705		
5 x 30	HBPH5130	--	x	10	5-1/8	30	3-1/2	--	3	6	16	16d	10	16d	6235	6235	6235	4950	--	6235	2705		
5-1/4 x 7-1/4	BPH55725	--	x	10	5-9/16	7-1/4	2-1/4	--	2-1/2	4	6	16d	6	10d	3065	3065	3065	2340	--	3065	850		
	HBPH55725	--	x	10	5-1/2	7-1/4	3-1/2	--	3	6	16	16d	10	16d	6235	6235	6235	4950	--	6235	2705		

EWP Hangers

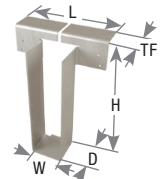
Copyright © 2019 MiTek Industries, Inc. All Rights Reserved

1) When I-joist is used as a header, all nails must be 10d x 1-1/2.  
 2) Uplift loads have been increased 60% for wind or seismic loads; no further increase shall be permitted  
 3) Some listed loads may be increased for short-term loading. Refer to code evaluation reports for MiTek USA, Inc. for details.  
 4) **When I-Joists with flanges less than 1-1/2" thick are used as headers, the reduction factor for 1-1/4" flange is 0.69 and 0.84 for 1-3/8" flange.**  
 5) **NAILS:** 10d nails are 0.148" dia. x 3" long, NA16D-RS nails are 0.148" x 3-1/2" long, 16d nails are 0.162" dia. x 3-1/2" long.  
**Load tables address hanger/header/fastener limitations only. Joist limitations must be determined for each installation.**  
 New products or updated product information are designated in blue font.



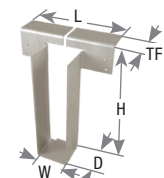
Joist Size (in)	MiTek USP Stock No.	Ref. No.	Web Stiff Req'd	Ga	Dimensions (in)					Fastener Schedule <sup>5</sup>					Allowable Loads Header Type (Lbs.) <sup>1,3</sup>							Code Ref.
					W	H	D	L	TF	Header			Joist		Download 100%							
										Top Qty	Face Qty	Type	Qty	Type	LVL	PSL	LSL	SPF	DF I-Joist <sup>4</sup>	DF/SP	DF/SP 160%	
5-1/4 x 9-1/4	HBPH55925	HB5.50/9.25	x	10	5-1/2	9-1/4	3-1/2	--	3	6	16	16d	10	16d	6235	6235	6235	4950	--	6235	2705	IBC, FL, LA
	PHXU55925	HWP5.37 H=9.25, HWP5.37 H=9.25	x	7	5-1/2	9-1/4	3-1/4	11-1/2	3	4	4	16d	6	10d	5910	5910	5910	4530	--	5910	1120	
	HLBH55925	HGLTV5.37 H=9.25	x	7	5-9/16	9-1/4	6	12	3-1/8	3	12	NA16D-RS	6	16d	10045	10045	10045	7680	--	10045	1580	
5-1/4 x 9-1/2	BPH5595	--	x	12	5-9/16	9-1/2	3	--	2-5/32	4	6	16d	4	10d	3065	3065	3065	2340	--	3065	850	
	HBPH5595	HB5.50/9.5	x	10	5-1/2	9-1/2	3-1/2	--	3	6	16	16d	10	16d	6235	6235	6235	4950	--	6235	2705	
	PHM5595	--	x	7/10	5-5/8	9-1/2	2-1/2	7	3	2	--	16d	2	10d	3265	3265	3265	2480	--	3265	--	
	PHXU5595	HWP5.37 H=9.5, HWP5.37 H=9.5	x	7	5-1/2	9-1/2	3-1/4	11-1/2	2-1/2	4	4	16d	6	10d	5910	5910	5910	4530	--	5910	1120	
5-1/4 x 11-1/4	HLBH5595	HGLTV5.37 H=9.5	x	7	5-9/16	9-1/2	6	12	3-1/8	3	12	NA16D-RS	6	16d	10045	10045	10045	7680	--	10045	1580	
	HBPH55112	HB5.50/11.25	x	10	5-1/2	11-1/4	3-1/2	--	3	6	16	16d	10	16d	6235	6235	6235	4950	--	6235	2705	
	PHXU55112	HWP5.37 H=11.25, HWP5.37 H=11.25	x	7	5-1/2	11-1/4	3-1/4	11-1/2	2-1/2	4	4	16d	6	10d	5910	5910	5910	4530	--	5910	1120	
5-1/4 x 11-1/2	HLBH55112	HGLTV5.37 H=11.25	x	7	5-9/16	11-1/4	6	12	3-1/8	3	12	NA16D-RS	6	16d	10045	10045	10045	7680	--	10045	1580	
	HLBH55115	--	x	7	5-9/16	11-1/2	6	12	3-1/8	3	12	NA16D-RS	6	16d	10045	10045	10045	7680	--	10045	1580	
5-1/4 x 11-7/8	BPH55118	--	x	12	5-9/16	11-7/8	2-1/2	--	2-1/32	4	6	16d	6	10d	3050	3050	3050	2340	--	3050	1275	
	HBPH55118	HB5.50/11.88	x	10	5-1/2	11-7/8	3-1/2	--	3	6	16	16d	10	16d	6235	6235	6235	4950	--	6235	2705	
	PHM55118	--	x	7/10	5-5/8	11-7/8	2-1/2	7	3	2	--	16d	2	10d	3265	3265	3265	2480	--	3265	--	
	PHXU55118	HWP5.37 H=11.875, HWP5.37 H=11.875	x	7	5-1/2	11-7/8	3-1/4	11-1/2	2-1/2	4	4	16d	6	10d	5910	5910	5910	4530	--	5910	1120	
	HLBH55118	HGLTV5.37 H=11.875	x	7	5-9/16	11-7/8	6	12	3-1/8	3	12	NA16D-RS	6	16d	10045	10045	10045	7680	--	10045	1580	
5-1/4 x 12	HBPH5512	--	x	10	5-1/2	12	3-1/2	--	3	6	16	16d	10	16d	6235	6235	6235	4950	--	6235	2705	
	PHXU5512	--	x	7	5-1/2	12	3-1/4	11-1/2	2-1/2	4	4	16d	6	10d	5910	5910	5910	4530	--	5910	1120	
	HLBH5512	--	x	7	5-9/16	12	6	12	3-1/8	3	12	NA16D-RS	6	16d	10045	10045	10045	7680	--	10045	1580	
5-1/4 x 14	BPH5514	--	x	12	5-9/16	14	2-1/2	--	2-1/32	4	6	16d	6	10d	3050	3050	3050	2340	--	3050	1275	
	HBPH5514	HB5.50/14	x	10	5-1/2	14	3-1/2	--	3	6	16	16d	10	16d	6235	6235	6235	4950	--	6235	2705	
	PHM5514	--	x	7/10	5-5/8	14	2-1/2	7	3	2	--	16d	2	10d	3265	3265	3265	2480	--	3265	--	
	PHXU5514	HWP5.37 H=14, HWP5.37 H=14	x	7	5-1/2	14	3-1/4	11-1/2	2-1/2	4	4	16d	6	10d	5910	5910	5910	4530	--	5910	1120	
	HLBH5514	HGLTV5.37 H=14	x	7	5-9/16	14	6	12	3-1/8	3	12	NA16D-RS	6	16d	10045	10045	10045	7680	--	10045	1580	
5-1/4 x 16	BPH5516	--	x	12	5-9/16	16	2-1/2	--	2-1/32	4	6	16d	6	10d	3050	3050	3050	2340	--	3050	1275	
	HBPH5516	HB5.50/16	x	10	5-1/2	16	3-1/2	--	3	6	16	16d	10	16d	6235	6235	6235	4950	--	6235	2705	
	PHM5516	--	x	7/10	5-5/8	16	2-1/2	7	3	2	--	16d	2	10d	3265	3265	3265	2480	--	3265	--	
	PHXU5516	HWP5.37 H=16, HWP5.37 H=16	x	7	5-1/2	16	3-1/4	11-1/2	2-1/2	4	4	16d	6	10d	5910	5910	5910	4530	--	5910	1120	
	HLBH5516	HGLTV5.37 H=16	x	7	5-9/16	16	6	12	3-1/8	3	12	NA16D-RS	6	16d	10045	10045	10045	7680	--	10045	1580	
5-1/4 x 18	BPH5518	--	x	12	5-9/16	18	2-1/2	--	2-1/32	4	6	16d	6	10d	3050	3050	3050	2340	--	3050	1275	
	HBPH5518	HB5.50/18	x	10	5-1/2	18	3-1/2	--	3	6	16	16d	10	16d	6235	6235	6235	4950	--	6235	2705	
	PHM5518	--	x	7/10	5-5/8	18	2-1/2	7	3	2	--	16d	2	10d	3265	3265	3265	2480	--	3265	--	
	PHXU5518	HWP5.37 H=18	x	7	5-1/2	18	3-1/4	11-1/2	2-1/2	4	4	16d	6	10d	5910	5910	5910	4530	--	5910	1120	
	HLBH5518	HGLTV5.37 H=18	x	7	5-9/16	18	6	12	3-1/8	3	12	NA16D-RS	6	16d	10045	10045	10045	7680	--	10045	1580	

1) When I-joist is used as a header, all nails must be 10d x 1-1/2.  
 2) Uplift loads have been increased 60% for wind or seismic loads; no further increase shall be permitted  
 3) Some listed loads may be increased for short-term loading. Refer to code evaluation reports for MiTek USA, Inc. for details.  
 4) When I-Joists with flanges less than 1-1/2" thick are used as headers, the reduction factor for 1-1/4" flange is 0.69 and 0.84 for 1-3/8" flange.  
 5) NAILS: 10d nails are 0.148" dia. x 3" long, NA16D-RS nails are 0.148" x 3-1/2" long, 16d nails are 0.162" dia. x 3-1/2" long.  
**Load tables address hanger/header/fastener limitations only. Joist limitations must be determined for each installation.**  
 New products or updated product information are designated in blue font.



Joist Size (in)	MiTek USP Stock No.	Ref. No.	Web Stiff Req'd	Ga	Dimensions (in)					Fastener Schedule <sup>5</sup>					Allowable Loads Header Type (Lbs.) <sup>1,3</sup>						Code Ref.	
					W	H	D	L	TF	Header			Joist		Download 100%							Uplift <sup>2</sup>
										Top Qty	Face Qty	Type	Qty	Type	LVL	PSL	LSL	SPF	DF I-Joist <sup>4</sup>	DF/SP		
5-1/4 x 20	HBP5520	HB5.50/20	x	10	5-1/2	20	3-1/2	--	3	6	16	16d	10	16d	6235	6235	6235	4950	--	6235	2705	IBC, FL, LA
	PHXU5520	HWP5.37 H=20	x	7	5-1/2	20	3-1/4	11-1/2	2-1/2	4	4	16d	6	10d	5910	5910	5910	4530	--	5910	1120	
	HLBH5520	HGLTV5.37 H=20	x	7	5-9/16	20	6	12	3-1/8	3	12	NA16D-RS	6	16d	10045	10045	10045	7680	--	10045	1580	
7 x 7-1/4	PHXU71725	--	x	7	7-1/8	7-1/4	3-1/4	13-1/8	2-1/2	4	4	16d	6	10d	5910	5910	5910	4525	--	5910	1120	
7 x 9-1/4	BPH71925	--	x	12	7-1/8	9-1/4	3	--	2-3/8	4	6	16d	6	10d	3100	3100	3100	2370	--	3100	1275	
	HBP71925	--	x	10	7-1/8	9-1/4	3-1/2	--	3	6	16	16d	10	16d	6235	6235	6235	4935	--	6235	2705	
	PHM35925-2	--	x	7/10	7-1/8	9-1/4	2-1/2	10	3	2	--	16d	2	10d	3390	3390	3390	2580	--	3390	--	
	PHXU71925	--	x	7	7-1/8	9-1/4	3-1/4	13-1/8	2-1/2	4	4	16d	6	10d	5910	5910	5910	4525	--	5910	1120	
	HLBH71925	--	x	7	7-1/8	9-1/4	6	12	3-1/8	3	12	NA16D-RS	6	16d	10045	10045	10045	7670	--	10045	1580	
7 x 9-1/2	BPH7195	--	x	12	7-1/8	9-1/2	3	--	2-3/8	4	6	16d	6	10d	3100	3100	3100	2370	--	3100	1275	
	HBP7195	HB7.12/9.5	x	10	7-1/8	9-1/2	3-1/2	--	3	6	16	16d	10	16d	6235	6235	6235	4935	--	6235	2705	
	PHM3595-2	--	x	7/10	7-1/8	9-1/2	2-1/2	10	3	2	--	16d	2	10d	3390	3390	3390	2580	--	3390	--	
	PHXU7195	HWP7.12 H=9.5	x	7	7-1/8	9-1/2	3-1/4	13-1/8	2-1/2	4	4	16d	6	10d	5910	5910	5910	4525	--	5910	1120	
	HLBH7195	--	x	7	7-1/8	9-1/2	6	12	3-1/8	3	12	NA16D-RS	6	16d	10045	10045	10045	7670	--	10045	1580	
7 x 11-1/4	BPH71112	--	x	12	7-1/8	11-1/4	3	--	2-3/16	4	6	16d	6	10d	3075	3075	3075	2350	--	3075	1275	
	HBP71112	HB7.12/11.25	x	10	7-1/8	11-1/4	3-1/2	--	3	6	16	16d	10	16d	6235	6235	6235	4935	--	6235	2705	
	PHXU71112	--	x	7	7-1/8	11-1/4	3-1/4	13-1/8	2-1/2	4	4	16d	6	10d	5910	5910	5910	4525	--	5910	1120	
	HLBH71112	--	x	7	7-1/8	11-1/4	6	12	3-1/8	3	12	NA16D-RS	6	16d	10045	10045	10045	7670	--	10045	1580	
7 x 11-7/8	BPH71118	--	x	12	7-1/8	11-7/8	3	--	2-3/16	4	6	16d	6	10d	3075	3075	3075	2350	--	3075	1275	
	HBP71118	HB7.12/11.88	x	10	7-1/8	11-7/8	3-1/2	--	3	6	16	16d	10	16d	6235	6235	6235	4935	--	6235	2705	
	PHM35118-2	--	x	7/10	7-1/8	11-7/8	2-1/2	10	3	2	--	16d	2	10d	3390	3390	3390	2580	--	3390	--	
	PHXU71118	HWP7.12 H=11.875	x	7	7-1/8	11-7/8	3-1/4	13-1/8	2-1/2	4	4	16d	6	10d	5910	5910	5910	4525	--	5910	1120	
	HLBH71118	--	x	7	7-1/8	11-7/8	6	12	3-1/8	3	12	NA16D-RS	6	16d	10045	10045	10045	7670	--	10045	1580	
7 x 14	BPH7114	--	x	12	7-1/8	14	3	--	2-3/16	4	6	16d	6	10d	3075	3075	3075	2350	--	3075	1275	
	HBP7114	HB7.12/14	x	10	7-1/8	14	3-1/2	--	3	6	16	16d	10	16d	6235	6235	6235	4935	--	6235	2705	
	PHM3514-2	--	x	7/10	7-1/8	14	2-1/2	10	3	2	--	16d	2	10d	3390	3390	3390	2580	--	3390	--	
	PHXU7114	HWP7.12 H=14	x	7	7-1/8	14	3-1/4	13-1/8	2-1/2	4	4	16d	6	10d	5910	5910	5910	4525	--	5910	1120	
	HLBH7114	--	x	7	7-1/8	14	6	12	3-1/8	3	12	NA16D-RS	6	16d	10045	10045	10045	7670	--	10045	1580	
7 x 16	BPH7116	--	x	12	7-1/8	16	3	--	2-3/16	4	6	16d	6	10d	3075	3075	3075	2350	--	3075	1275	
	HBP7116	HB7.12/16	x	10	7-1/8	16	3-1/2	--	3	6	16	16d	10	16d	6235	6235	6235	4935	--	6235	2705	
	PHM3516-2	--	x	7/10	7-1/8	16	2-1/2	10	3	2	--	16d	2	10d	3390	3390	3390	2580	--	3390	--	
	PHXU7116	HWP7.12 H=16	x	7	7-1/8	16	3-1/4	13-1/8	2-1/2	4	4	16d	6	10d	5910	5910	5910	4525	--	5910	1120	
	HLBH7116	--	x	7	7-1/8	16	6	12	3-1/8	3	12	NA16D-RS	6	16d	10045	10045	10045	7670	--	10045	1580	

1) When I-joist is used as a header, all nails must be 10d x 1-1/2.  
 2) Uplift loads have been increased 60% for wind or seismic loads; no further increase shall be permitted.  
 3) Some listed loads may be increased for short-term loading. Refer to code evaluation reports for MiTek USA, Inc. for details.  
 4) **When I-Joists with flanges less than 1-1/2" thick are used as headers, the reduction factor for 1-1/4" flange is 0.69 and 0.84 for 1-3/8" flange.**  
 5) **NAILS:** 10d nails are 0.148" dia. x 3" long, NA16D-RS nails are 0.148" x 3-1/2" long, 16d nails are 0.162" dia. x 3-1/2" long.  
**Load tables address hanger/header/fastener limitations only. Joist limitations must be determined for each installation.**  
 New products or updated product information are designated in **blue font**.



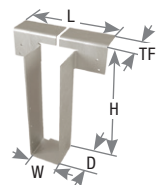
Joist Size (in)	MiTek USP Stock No.	Ref. No.	Web Stiff Req'd	Ga	Dimensions (in)					Fastener Schedule <sup>5</sup>					Allowable Loads Header Type (Lbs.) <sup>1,3</sup>							Code Ref.
					W	H	D	L	TF	Header		Joist			Download 100%					Uplift <sup>2</sup>		
										Top Qty	Face Qty	Type	Qty	Type	LVL	PSL	LSL	SPF	DF I-Joist <sup>4</sup>	DF/SP	DF/SP 160%	
7 x 18	BPH7118	--	x	12	7-1/8	18	3	--	2-3/16	4	6	16d	6	10d	3075	3075	3075	2350	--	3075	1275	
	HBP7118	HB7.12/18	x	10	7-1/8	18	3-1/2	--	3	6	16	16d	10	16d	6235	6235	6235	4935	--	6235	2705	
	PHM3518-2	--	x	7/10	7-1/8	18	2-1/2	10	3	2	--	16d	2	10d	3390	3390	3390	2580	--	3390	--	
	PHXU7118	HWP7.12 H=18, HWP7.12 H=18	x	7	7-1/8	18	3-1/4	13-1/8	2-1/2	4	4	16d	6	10d	5910	5910	5910	4525	--	5910	1120	
	HLBH7118	--	x	7	7-1/8	18	6	12	3-1/8	3	12	NA16D-RS	6	16d	10045	10045	10045	7670	--	10045	1580	
7 x 20	BPH7120	--	x	12	7-1/8	20	3	--	2-3/16	4	6	16d	6	10d	3075	3075	3075	2350	--	3075	1275	
	HBP7120	HB7.12/20	x	10	7-1/8	20	3-1/2	--	3	6	16	16d	10	16d	6235	6235	6235	4935	--	6235	2705	
	PHM3520-2	--	x	7/10	7-1/8	20	2-1/2	10	3	2	--	16d	2	10d	3390	3390	3390	2580	--	3390	--	
	PHXU7120	HWP7.12 H=20, HWP7.12 H=20	x	7	7-1/8	20	3-1/4	13-1/8	2-1/2	4	4	16d	6	10d	5910	5910	5910	4525	--	5910	1120	
	HLBH7120	--	x	7	7-1/8	20	6	12	3-1/8	3	12	NA16D-RS	6	16d	10045	10045	10045	7670	--	10045	1580	
7 x 22	BPH7122	--	x	12	7-1/8	22	3	--	2-3/16	4	6	16d	6	10d	3075	3075	3075	2350	--	3075	1275	
	HBP7122	HB7.12/22	x	10	7-1/8	22	3-1/2	--	3	6	16	16d	10	16d	6235	6235	6235	4935	--	6235	2705	
	PHXU7122	HWP7.12 H=22, HWP7.12 H=22	x	7	7-1/8	22	3-1/4	13-1/8	2-1/2	4	4	16d	6	10d	5910	5910	5910	4525	--	5910	1120	
	HLBH7122	HGLTV7.12/22	x	7	7-1/8	22	6	12	3-1/8	3	12	NA16D-RS	6	16d	10045	10045	10045	7670	--	10045	1580	
7 x 24	BPH7124	--	x	12	7-1/8	24	3	--	2-3/16	4	6	16d	6	10d	3075	3075	3075	2350	--	3075	1275	
	HBP7124	HB7.12/24	x	10	7-1/8	24	3-1/2	--	3	6	16	16d	10	16d	6235	6235	6235	4935	--	6235	2705	
	PHXU7124	HWP7.12 H=24, HWP7.12 H=24	x	7	7-1/8	24	3-1/4	13-1/8	2-1/2	4	4	16d	6	10d	5910	5910	5910	4525	--	5910	1120	
	HLBH7124	HGLTV7.12/24	x	7	7-1/8	24	6	12	3-1/8	3	12	NA16D-RS	6	16d	10045	10045	10045	7670	--	10045	1580	
7 x 26	HBP7126	HB7.12/26	x	10	7-1/8	26	3-1/2	--	3	6	16	16d	10	16d	6235	6235	6235	4935	--	6235	2705	
	PHXU7126	HWP7.12 H=26, HWP7.12 H=26	x	7	7-1/8	26	3-1/4	13-1/8	2-1/2	4	4	16d	6	10d	5910	5910	5910	4525	--	5910	1120	
	HLBH7126	HGLTV426-2	x	7	7-1/8	26	6	12	3-1/8	3	12	NA16D-RS	6	16d	10045	10045	10045	7670	--	10045	1580	
7 x 28	HBP7128	HB7.12/28	x	10	7-1/8	28	3-1/2	--	3	6	16	16d	10	16d	6235	6235	6235	4935	--	6235	2705	
	PHXU7128	HWP7.12 H=28, HWP7.12 H=28	x	7	7-1/8	28	3-1/4	13-1/8	2-1/2	4	4	16d	6	10d	5910	5910	5910	4525	--	5910	1120	
	HLBH7128	HGLTV428-2	x	7	7-1/8	28	6	12	3-1/8	3	12	NA16D-RS	6	16d	10045	10045	10045	7670	--	10045	1580	
7 x 30	PHXU7130	HWP7.12 H=30	x	7	7-1/8	30	3-1/4	13-1/8	2-1/2	4	4	16d	6	10d	5910	5910	5910	4525	--	5910	1120	
	HLBH7130	HGLTV430-2	x	7	7-1/8	30	6	12	3-1/8	3	12	NA16D-RS	6	16d	10045	10045	10045	7670	--	10045	1580	
7 x 32	PHXU7132	--	x	7	7-1/8	32	3-1/4	13-1/8	2-1/2	4	4	16d	6	10d	5910	5910	5910	4525	--	5910	1120	
	HLBH7132	--	x	7	7-1/8	32	6	12	3-1/8	3	12	NA16D-RS	6	16d	10045	10045	10045	7670	--	10045	1580	

IBC, FL, LA

- 1) When I-joist is used as a header, all nails must be 10d x 1-1/2.
  - 2) Uplift loads have been increased 60% for wind or seismic loads; no further increase shall be permitted
  - 3) Some listed loads may be increased for short-term loading. Refer to code evaluation reports for MiTek USA, Inc. for details.
  - 4) **When I-Joists with flanges less than 1-1/2" thick are used as headers, the reduction factor for 1-1/4" flange is 0.69 and 0.84 for 1-3/8" flange.**
  - 5) **NAILS:** 10d nails are 0.148" dia. x 3" long, NA16D-RS nails are 0.148" x 3-1/2" long, 16d nails are 0.162" dia. x 3-1/2" long.
- Load tables address hanger/header/fastener limitations only. Joist limitations must be determined for each installation.**  
 New products or updated product information are designated in **blue font**.

Copyright © 2019 MiTek Industries, Inc. All Rights Reserved

EWP Hangers



The TMP and TMPH are designed to make rafter-to-plate connections and eliminate time-consuming bird's-mouth notching or bevel plate installation. Both series are available in I-Joists sizes, as well as standard 2x sizes.

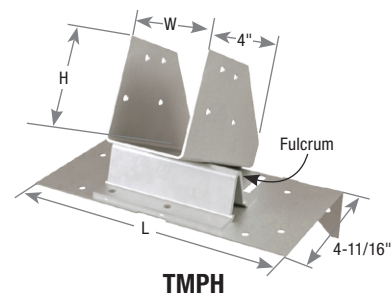
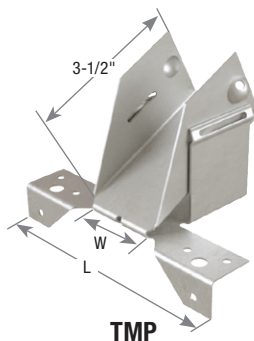
**TMP** – Adjusts to pitches from 1/12 to 6/12.

**TMPH** – Adjusts to pitches from 6/12 to 14/12.

**Materials:** TMP – 18 gauge;  
 TMPH – 16 gauge, Fulcrum – 12 gauge

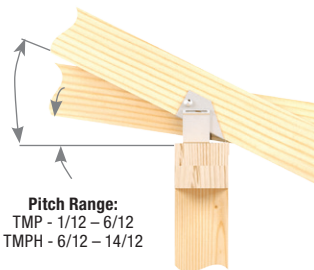
**Finish:** G90 galvanizing

**Codes:** See page 12 for Code Reference Chart



**Installation:**

- Use all specified fasteners. See Product Notes, page 20.
- Position connector on top plate. Fasten connector to outside of top plate with specified nails. Insert rafter into rafter pocket. Adjust rafter and pocket to correct pitch. Fasten rafter to connector with specified nails. Installing the TMP requires driving specified nails through the opposing slots in the pocket. TMPH installation involves sliding the fulcrum until it supports the pocket at the desired pitch and nailing down through the fulcrum base into the top plate to lock the fulcrum into position.



Typical TMP installation



Typical TMPH installation

**TMP Chart**

Rafter Width (in)	MiTek USP Stock No.	Ref. No.	Steel Gauge	Dimensions (in)		Fastener Schedule <sup>2</sup>				DF/SP Allowable Loads (Lbs.) <sup>1</sup>		S-P-F Allowable Loads (Lbs.) <sup>1</sup>		Code Ref.
						Plate		Rafter		Download	Uplift	Download	Uplift	
				W	L	Qty	Type	Qty	Type	(100/115/125)	160%	(100/115/125)	160%	
1-1/2	TMP2	VPA2	18	1-9/16	5-9/16	6	10d	4	10d x 1-1/2	1705	250	1705	190	IBC, FL, LA
1-3/4	TMP175	VPA25	18	1-13/16	5-9/16	6	10d	4	10d x 1-1/2	1705	250	1705	190	
2 or 2-1/8	TMP21	VPA2.06, VPA2.1	18	2-1/8	6-3/8	6	10d	4	10d x 1-1/2	1705	250	1705	190	
2-5/16	TMP23	VPA35	18	2-3/8	6-3/8	6	10d	4	10d x 1-1/2	1705	250	1705	190	
2-1/2 or 2-5/8	TMP25	VPA3	18	2-11/16	6-3/8	6	10d	4	10d x 1-1/2	1705	250	1705	190	
3	TMP31	--	18	3-1/8	7-5/16	6	10d	4	10d x 1-1/2	1705	250	1705	190	
3-1/2	TMP4	VPA4	18	3-9/16	7-5/16	6	10d	4	10d x 1-1/2	1705	250	1705	190	

1) Allowable Loads are governed by test results; no further increase shall be permitted  
 2) **NAILS:** 10d x 1-1/2 nails are 0.148" dia. x 1-1/2" long, 10d nails are 0.148" dia. x 3" long.  
 New products or updated product information are designated in **blue font**.

**TMPH Chart**

Rafter Width (in)	MiTek USP Stock No.	Ref. No.	Dimensions (in)			Fastener Schedule <sup>3</sup>					DF/SP Allowable Loads (Lbs.) <sup>1</sup>										Code Ref.
						Plate		Rafter <sup>2</sup>			According to Pitch										
			W	H	L	Top Qty	Side Qty	Type	Qty	Type	6/12	7/12	8/12	9/12	10/12	11/12	12/12	13/12	14/12	Uplift 160%	
1-1/2	TMPH2	VPA2	1-9/16	2-1/2	6-9/16	8	2	10d	8	10d x 1-1/2	3190	3290	3390	3140	2900	2710	2520	2230	1950	260	IBC, FL, LA
1-3/4	TMPH175	VPA25	1-13/16	2-3/8	6-9/16	8	2	10d	8	10d x 1-1/2	3190	3290	3390	3140	2900	2710	2520	2230	1950	260	
2 or 2-1/8	TMPH21	VPA2.06, VPA2.1	2-1/8	2-5/8	7-3/8	8	2	10d	8	10d x 1-1/2	3190	3290	3390	3140	2900	2710	2520	2230	1950	260	
2-5/16	TMPH23	VPA35	2-3/8	2-1/2	7-3/8	8	2	10d	8	10d x 1-1/2	3190	3290	3390	3140	2900	2710	2520	2230	1950	260	
2-1/2 or 2-5/8	TMPH25	VPA3	2-11/16	2-5/16	7-3/8	8	2	10d	8	10d x 1-1/2	3190	3290	3390	3140	2900	2710	2520	2230	1950	260	
3	TMPH31	--	3-1/8	2-11/16	8-9/16	8	2	10d	8	10d x 1-1/2	3190	3290	3390	3140	2900	2710	2520	2230	1950	260	
3-1/2	TMPH4	VPA4	3-9/16	2-1/2	8-9/16	8	2	10d	8	10d x 1-1/2	3190	3290	3390	3140	2900	2710	2520	2230	1950	260	

1) Allowable loads may not be increased for duration of load adjustments.  
 2) Web stiffeners are required for all Wood I-Joist installations.  
 3) **NAILS:** 10d x 1-1/2 nails are 0.148" dia. x 1-1/2" long, 10d nails are 0.148" dia. x 3" long.  
 New products or updated product information are designated in **blue font**.



The LSSH series connects rafters to ridge beams in vaulted roof structures. This series is field adjustable to meet a variety of skew and/or slope applications. Slopes and skews 0° to 45°.

**Materials:** See chart

**Finish:** G90 galvanizing; LSSH15-TZ – G-185 galvanizing

**Options:** See chart for Corrosion Finish Options

**Codes:** See page 12 for Code Reference Chart

**Installation:**

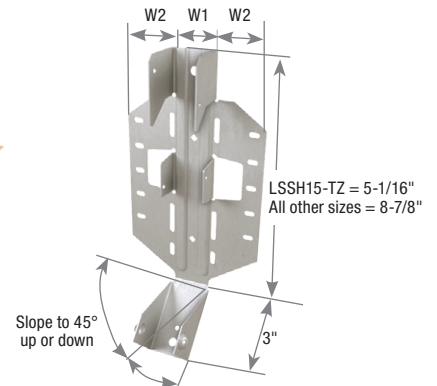
- Use all specified fasteners. See Product Notes, page 20.

**Steps:**

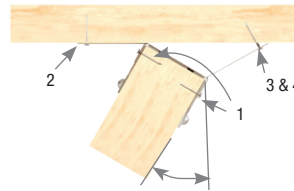
1. Position LSSH connector against plumb-cut end of joist. Fasten joist side flanges on both sides with 10d (0.148") x 1-1/2" nails. Bend seat up to fit against joist bottom and drive (1) 10d (0.148") x 1-1/2" nail through bottom seat into rafter bottom. Drive (2) 10d (0.148") x 1-1/2" nails at downward angle through dimpled nailing guides.
  2. Lean connector and rafter end against ridge beam at desired position. Install specified 10d (0.148" x 3") or 16d (0.162" x 3-1/2") nails through nail holes into ridge beam at right 90° angle. If skewing the rafter, only drive nails into ridge beam on inside flange.
  3. Bend flange to desired angle.
  4. Hammer outside flange until edge touches header. Fasten outside flange to ridge by driving specified 10d (0.148" x 3) or 16d (0.162" x 3-1/2") nails through nail holes.
- Web stiffeners are required for all wood I-Joist installations.
  - Designer may consider adding a tension restraint for the supported member for roof slopes exceeding 6/12. Refer to pages 112-113.



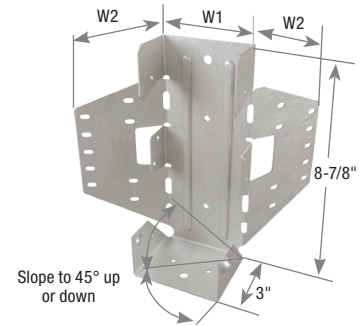
Typical LSSH179 installation



LSSH210



Skew to 45° maximum



LSSH35

Rafter Width (in)	MiTek USP Stock No.	Ref. No.	Steel Gauge	Dimensions (in)		Fastener Schedule <sup>2</sup>				DF/SP Allowable Loads (Lbs.)				S-P-F Allowable Loads (Lbs.)				Corrosion Finish	Code Ref.
				W1	W2	Header		Rafter		Floor	Roof	Uplift <sup>1</sup>	160%	100%	115%	125%	160%		
						Qty	Type	Qty	Type										
<b>SLOPED ONLY HANGERS</b>																			
1-1/2	LSSH15-TZ	LSSJ26LZ, LSSJ26RZ, LSSJ28LZ, LSSJ28RZ	18	1-9/16	1-3/4	6	10d HDG	7	10d x 1-1/2 HDG	720	830	900	575	640	730	785	450	IBC, FL	
1-1/2	LSSH210	LSSJ210LZ, LSSJ210RZ	18	1-9/16	1-3/4	10	10d	7	10d x 1-1/2	1200	1380	1395	410	1065	1090	1090	320	IBC, FL, LA	
1-3/4	LSSH179	LSSR1.81Z	18	1-13/16	1-5/8	10	10d	7	10d x 1-1/2	1200	1380	1395	880	1065	1090	1090	690		
2 - 2-1/8	LSSH20	LSSR2.1Z	18	2-1/8	2-1/2	10	10d	7	10d x 1-1/2	1200	1380	1395	795	1065	1085	1085	620		
2-1/4 - 2-5/16	LSSH23	LSSR2.37Z	18	2-5/16	2-3/8	10	10d	7	10d x 1-1/2	1200	1380	1395	795	1065	1085	1085	620		
2-1/2	LSSH25	LSSR2.56Z	16	2-9/16	2-3/4	18	16d	12	10d x 1-1/2	2095	2095	2095	945	1640	1640	1640	740		
2-5/8	LSSH26	--	16	2-11/16	2-5/8	18	16d	12	10d x 1-1/2	2095	2095	2095	945	1640	1640	1640	740		
3	LSSH31	LSSR210-2Z	16	3-1/8	3-3/4	18	16d	12	10d x 1-1/2	2645	3045	3100	1310	2345	2425	2425	1025		
3-1/2	LSSH35	LSSR410Z	16	3-9/16	3-1/2	18	16d	12	10d x 1-1/2	2645	3045	3100	1310	2345	2415	2415	1020		
<b>SKEWED HANGERS or SLOPED &amp; SKEWED HANGERS</b>																			
1-1/2	LSSH15-TZ	LSSJ26LZ, LSSJ26RZ, LSSJ28LZ, LSSJ28RZ	18	1-9/16	1-3/4	6	10d HDG	7	10d x 1-1/2 HDG	625	625	625	515	490	490	490	405	IBC, FL	
1-1/2	LSSH210	LSSJ210LZ, LSSJ210RZ	18	1-9/16	1-3/4	10	10d	7	10d x 1-1/2	1200	1380	1395	880	1065	1090	1090	690	IBC, FL, LA	
1-3/4	LSSH179	LSSR1.81Z	18	1-13/16	1-5/8	10	10d	7	10d x 1-1/2	1200	1380	1395	880	1065	1090	1090	690		
2 - 2-1/8	LSSH20	LSSR2.1Z	18	2-1/8	2-1/2	10	10d	7	10d x 1-1/2	1200	1230	1230	795	960	960	960	620		
2-1/4 - 2-5/16	LSSH23	LSSR2.37Z	18	2-5/16	2-3/8	10	10d	7	10d x 1-1/2	1200	1230	1230	795	955	955	955	620		
2-1/2	LSSH25	LSSR2.56Z	16	2-9/16	2-3/4	14	16d	12	10d x 1-1/2	1610	1610	1610	945	1260	1260	1260	740		
2-5/8	LSSH26	--	16	2-11/16	2-5/8	14	16d	12	10d x 1-1/2	1610	1610	1610	945	1260	1260	1260	740		
3	LSSH31	LSSR210-2Z	16	3-1/8	3-3/4	14	16d	12	10d x 1-1/2	1610	1610	1610	1310	1260	1260	1260	1025		
3-1/2	LSSH35	LSSR410Z	16	3-9/16	3-1/2	14	16d	12	10d x 1-1/2	1610	1610	1610	1310	1255	1255	1255	1020		

1) Uplift loads have been increased 60% for wind or seismic loads; no further increase shall be permitted.  
 2) **NAILS:** 10d x 1-1/2 nails are 0.148" dia. x 1-1/2" long, 10d nails are 0.148" dia. x 3" long, 16d nails are 0.162" dia. x 3-1/2" long. New products or updated product information are designated in blue font.

**Corrosion Finish**

- Stainless Steel
- Gold Coat
- HDG
- Triple Zinc

**LGU, MGU, and HGU's** are high capacity girder to girder face mount connectors. Fastening is by WS structural screws for ease of installation. Fastenings are placed high on connector to permit the connection of a deep carried member to a shallower carrying member. Very useful where tops of beams must be flush.

**Materials:** LGU/MGU – 10 gauge; HGU – 7 gauge

**Finish:** G90 galvanizing

**Options:** See Specialty Options chart.

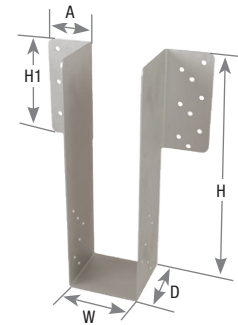
**Codes:** See page 12 for Code Reference Chart

**Installation:**

- Use all specified fasteners. See Product Notes, page 20.
- WS structural screws supplied with connector. Substituting lag screws will reduce capacity.
- Beams comprised of multiple plies must be laminated to act as a single member.
- Multi-ply carrying beams may require additional connection of laminations at connector.
- Beam height dimension (H) must be specified when ordering.



**Typical LGU, MGU, HGU installation**



**LGU, MGU, HGU**

Beam Width (in)	MiTek USP Stock No.	Ref. No.	Steel Gauge	Dimensions (in)					Fastener Schedule <sup>3</sup>				DF/SP Allowable Loads (Lbs.)				S-P-F Allowable Loads (Lbs.)			Code Ref.	
				W	H <sup>2</sup> (min)	H1	D	A	Header		Truss		100%	115%	125%	160%	100%	115%	125%		160%
									Qty	Type	Qty	Type									
3-1/8	LGU325	LGU3.25-SDS	10	3-1/4	8	7-3/8	4-1/2	3-1/4	18	WS3	12	WS3	7135	7410	7410	4160	5960	5960	5960	3345	IBC, FL, LA
3-1/2	LGU363	LGU3.63-SDS	10	3-5/8	8	7-3/8	4-1/2	3-1/4	18	WS3	12	WS3	7135	7410	7410	4160	5945	5945	5945	3340	
	MGU363	MGU3.63-SDS	10	3-5/8	9-1/4	8-5/8	4-1/2	4	24	WS3	16	WS3	9515	10940	11890	5100	8355	9610	9705	4115	
5-1/8	HGU363	HGU3.63-SDS	7	3-5/8	11	10-3/8	5-1/4	4-3/4	38	WS3	24	WS3	14705	14990	14990	7375	12175	12175	12175	5990	
	LGU525	LGU5.25-SDS	10	5-1/4	8	7-3/8	4-1/2	3-1/4	18	WS3	12	WS3	7135	7410	7410	4160	5910	5910	5910	3320	
5-1/4	MGU525	MGU5.25-SDS	10	5-1/4	9-1/4	8-5/8	4-1/2	4	24	WS3	16	WS3	9515	10940	11890	5100	8355	9610	9640	4085	
	HGU525	HGU5.25-SDS	7	5-1/4	11	10-3/8	5-1/4	4-3/4	38	WS3	24	WS3	14705	14990	14990	7375	12070	12070	12070	5935	
5-1/2	MGU550	MGU5.50-SDS	10	5-1/2	9-1/4	8-5/8	4-1/2	4	24	WS3	16	WS3	9515	10940	11890	5100	8355	9610	9635	4085	
	HGU550	HGU5.50-SDS	7	5-1/2	11	10-3/8	5-1/4	4-3/4	38	WS3	24	WS3	14705	14990	14990	7375	12060	12060	12060	5930	
6-3/4	MGU562	MGU5.62-SDS	10	5-5/8	9-1/4	8-5/8	4-1/2	4	24	WS3	16	WS3	9515	10940	11890	5100	8355	9610	9625	4080	
	HGU562	HGU5.62-SDS	7	5-5/8	11	10-3/8	5-1/4	4-3/4	38	WS3	24	WS3	14705	14990	14990	7375	12050	12050	12050	5930	
7	MGU700	MGU7.00-SDS	10	7	9-1/4	8-5/8	4-1/2	4	24	WS3	16	WS3	9515	10940	11890	5100	8355	9590	9590	4065	
	HGU700	HGU7.00-SDS	7	7	11	10-3/8	5-1/4	4-3/4	38	WS3	24	WS3	14705	14990	14990	7375	12010	12010	12010	5910	
8-3/4	HGU900	HGU9.00-SDS	7	9	11	10-3/8	5-1/4	4-3/4	38	WS3	24	WS3	14705	14990	14990	7375	12000	12000	12000	5905	
8-3/4	HGU900	HGU9.00-SDS	7	9	11	10-3/8	5-1/4	4-3/4	38	WS3	24	WS3	14705	14990	14990	7375	11960	11960	11960	5885	

1) Uplift loads have been increased 60% for wind or seismic loads; no further increase shall be permitted.  
 2) H denotes minimum hanger height. Specify height when ordering.  
 3) WS3 Wood Screws are 1/4" dia. x 3" long and are included with hangers.

**Specialty Options Chart**

– refer to Specialty Options pages 283-284 for additional details

Option	MiTek USP Series	Skewed <sup>1</sup>	Inverted Flange
<b>Range</b>	LGU MGU HGU	1° to 45°	One Inverted Flange option available on some sizes. See footnotes 2 and 3.
<b>Allowable Loads</b>	LGU	55% of table value. 30% of uplift.	100% of table value
	MGU	65% of table value. 30% of uplift.	
	HGU	70% of table value. 30% of uplift.	
<b>Ordering</b>	LGU MGU HGU	Add <i>SK</i> , angle required, right ( <i>R</i> ) or left ( <i>L</i> ), and square cut ( <i>SQ</i> ) or bevel cut ( <i>BI</i> ) to product number. Ex. LGU525_H=18_SK45R_SQ	Add <i>IF</i> and right ( <i>R</i> ) or left ( <i>L</i> ) to product number. Ex. LGU525_H=18_IFR

- 1) Skewed hangers with skews greater than 15° may have all joist fasteners on outside flange.
- 2) One inverted-flange (IF) is available on the following sizes: LGU363, LGU525, MGU525, MGU550, MGU563, MGU700, HGU525, HGU550, HGU562, HGU700, HGU725, HGU900
- 3) The inverted flange option is not available on skewed LGU, MGU or HGU hangers.
- 4) Bevel cut required on skewed parts to meet table loads.
- 5) Skewed hangers typically require a bevel cut however, a square cut option may be available as a custom when requested.

# GHF Glulam Face Mount Hangers

An architectural choice for exposed glulam purlin applications. The GHF features heavy load capacity and a multitude of optional designs for unusual applications. Header fasteners are positioned high and joist flange fasteners low for best design with glulam members.

**Materials:** See chart

**Finish:** Primer

**Options:** See Specialty Options Chart on page 212.

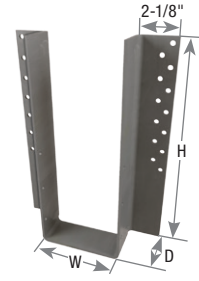
**Codes:** See page 12 for Code Reference Chart

**Installation:**

- Use all specified fasteners. See Product Notes, page 20.
- WS Wood Screws are supplied with GHF hangers.



Typical GHF51135 installation



GHF

Glulam Size (in)	MiTek USP Stock No.	Ref. No.	Steel Gauge	Dimensions (in)			Fastener Schedule <sup>2</sup>				DF/SP Allowable Loads (Lbs.) <sup>1</sup>				Code Ref.
				W	H	D	Header		Joist		Floor 100%	Roof 115%	Roof 125%	Uplift <sup>3</sup> 160%	
							Qty	Type	Qty	Type					
3-1/8 x 6	GHF31600	--	12	3-3/16	5-7/8	2-3/8	10	WS25	4	WS25	2740	2740	2740	1400	--
3-1/8 x 7-1/2	GHF31750	--	12	3-3/16	7-3/8	2-3/8	12	WS25	4	WS25	3285	3285	3285	1400	--
3-1/8 x 9	GHF31900	--	12	3-3/16	8-7/8	2-3/8	16	WS25	5	WS25	4380	4380	4380	1750	--
3-1/8 x 10-1/2	GHF31105	--	12	3-3/16	10-3/8	2-3/8	20	WS25	6	WS25	5475	5475	5475	2100	--
3-1/8 x 12	GHF31120	--	12	3-3/16	11-7/8	2-3/8	22	WS25	6	WS25	5800	5800	5800	2100	--
3-1/8 x 13-1/2	GHF31135	--	12	3-3/16	13-3/8	2-3/4	24	WS25	6	WS25	5800	5800	5800	2100	--
3-1/8 x 15	GHF31150	--	12	3-3/16	14-7/8	2-3/4	26	WS25	7	WS25	6730	6730	6730	2455	--
3-1/8 x 16-1/2	GHF31165	--	12	3-3/16	16-3/8	2-3/4	28	WS25	9	WS25	7275	7275	7275	3155	--
3-1/8 x 18	GHF31178	--	12	3-3/16	17-3/4	2-3/4	30	WS25	11	WS25	7825	7825	7825	3855	--
3-1/4 x 9	GHF32900	--	12	3-5/16	8-7/8	2-3/8	16	WS25	5	WS25	4380	4380	4380	1750	--
3-1/4 x 12	GHF32120	--	12	3-5/16	11-7/8	2-3/8	22	WS25	6	WS25	5800	5800	5800	2100	--
5-1/8 x 6	GHF51600	--	12	5-3/16	5-7/8	2-3/8	10	WS3	4	WS3	2740	2740	2740	1400	--
5-1/8 x 7-1/2	GHF51750	--	12	5-3/16	7-3/8	2-3/8	14	WS3	4	WS3	3835	3835	3835	1400	--
5-1/8 x 9	GHF51900	--	12	5-3/16	8-7/8	2-3/8	18	WS3	5	WS3	4930	4930	4930	1750	--
5-1/8 x 10-1/2	GHF51105	--	12	5-3/16	10-3/8	2-3/8	22	WS3	6	WS3	6025	6025	6025	2100	--
5-1/8 x 12	GHF51120	--	12	5-3/16	11-7/8	2-3/8	24	WS3	6	WS3	6570	6570	6570	2100	--
5-1/8 x 13-1/2	GHF51135	--	7	5-3/16	13-3/8	2-3/8	26	WS3	6	WS3	8125	8125	8125	2400	--
5-1/8 x 15	GHF51150	--	7	5-3/16	14-7/8	2-3/4	28	WS3	7	WS3	8750	8750	8750	2800	--
5-1/8 x 16-1/2	GHF51165	--	7	5-3/16	16-3/8	2-3/4	30	WS3	7	WS3	9375	9375	9375	2800	--
5-1/8 x 18	GHF51178	--	7	5-3/16	17-3/4	2-3/4	32	WS3	8	WS3	10000	10000	10000	3200	--
5-1/8 x 19-1/2	GHF51192	--	7	5-3/16	19-1/8	2-3/4	34	WS3	8	WS3	10395	10395	10395	3200	--
5-1/8 x 21	GHF51205	--	7	5-3/16	20-3/8	2-3/4	36	WS3	9	WS3	10705	10705	10705	3600	--
5-1/8 x 24	GHF51233	--	7	5-3/16	23-1/4	2-3/4	40	WS3	11	WS3	11330	11330	11330	4400	--
5-1/4 x 9	GHF52900	--	12	5-5/16	8-7/8	2-3/8	18	WS3	5	WS3	4930	4930	4930	1750	--
5-1/4 x 12	GHF52120	--	12	5-5/16	11-7/8	2-3/8	24	WS3	6	WS3	6570	6570	6570	2100	--
6-3/4 x 6	GHF67600	--	12	6-7/8	5-7/8	2-3/8	12	WS3	4	WS3	3285	3285	3285	1400	--
6-3/4 x 7-1/2	GHF67750	--	12	6-7/8	7-3/8	2-3/8	16	WS3	5	WS3	4380	4380	4380	1750	--
6-3/4 x 9	GHF67900	--	12	6-7/8	8-7/8	2-3/8	20	WS3	6	WS3	5475	5475	5475	2100	--
6-3/4 x 10-1/2	GHF67105	--	12	6-7/8	10-3/8	2-3/8	24	WS3	8	WS3	6570	6570	6570	2805	--
6-3/4 x 12	GHF67120	--	7	6-7/8	11-7/8	2-3/4	28	WS3	8	WS3	8750	8750	8750	3200	--
6-3/4 x 13-1/2	GHF67135	--	7	6-7/8	13-3/8	2-3/4	30	WS3	8	WS3	9375	9375	9375	3200	--
6-3/4 x 15	GHF67150	--	7	6-7/8	14-7/8	2-3/4	32	WS3	10	WS3	10000	10000	10000	4000	--
6-3/4 x 16-1/2	GHF67165	--	7	6-7/8	16-3/8	2-3/4	34	WS3	10	WS3	10625	10625	10625	4000	--
6-3/4 x 18	GHF67180	--	7	6-7/8	17-3/4	2-3/4	36	WS3	12	WS3	11250	11250	11250	4800	--
6-3/4 x 19-1/2	GHF67195	--	7	6-7/8	19-1/8	3	40	WS3	14	WS3	12500	12500	12500	5600	--
6-3/4 x 21	GHF67210	--	7	6-7/8	20-3/8	3	44	WS3	18	WS3	13000	13000	13000	7200	--
6-3/4 x 22-1/2	GHF67225	--	7	6-7/8	21-7/8	3	46	WS3	20	WS3	13000	13000	13000	8000	--
6-3/4 x 24	GHF67240	--	7	6-7/8	23-1/4	3	48	WS3	22	WS3	13000	13000	13000	8800	--

1) Allowable loads based on seat bearing calculated at 560 psi perpendicular to grain.  
 2) WS25 Wood Screws are 1/4" dia. x 2-1/2" long, WS3 Wood Screws are 1/4" dia. x 3" long and are included with GHF hangers.  
 3) Uplift loads have been increased 60% for wind or seismic loads; no further increase shall be permitted.

# GHF Glulam Face Mount Hangers



## Specialty Options Chart

– refer to Specialty Options pages 283-284 for additional details

Option	Skewed <sup>1,3</sup>	Sloped Seat <sup>2</sup>	Sloped / Skewed <sup>1,2</sup>	Inverted Flange
Range	1° to 50°	1° to 45°	See Sloped Seat and Skewed	Not available in widths less than 4-1/2"
Allowable Loads	100% of table load. 75% of uplift load on skewers greater than 15°.	100% of table load	80% of table load 75% of uplift load on skewers greater than 15°.	100% of table load. 65% of table load when fastening into the support members end grain.
Ordering	Add <i>SK</i> , angle required, right ( <i>R</i> ) or left ( <i>L</i> ), and square cut ( <i>SQ</i> ) or bevel cut ( <i>BV</i> ) to product number. Ex. GHF31900_SK45R_BV	Add <i>SL</i> , slope required, and up ( <i>U</i> ) or down ( <i>D</i> ), to product number. Ex. GHF31900_SL30D	See Sloped Seat and Skewed. Ex. GHF31900_SK45R_BV_SL30D	Add <i>IF</i> to product number. Ex. GHF51135_IF



**Typical GHF51135IF inverted flange installation**

- 1) Skewed hangers with skewers greater than 15° may have all joist nailing on outside flange.
- 2) Sloped or sloped / skewed hangers with slopes greater than 15° may have additional joist nails.
- 3) Skewed hangers typically require a bevel cut however, a square cut option may be available as a custom when requested.

# KEGQ Glulam Beam Hangers

WS Wood Screw fastening, heavy steel construction, and a continuous top flange allow the KEGQ products to have high load capacities.

**Materials:** See chart

**Finish:** Primer

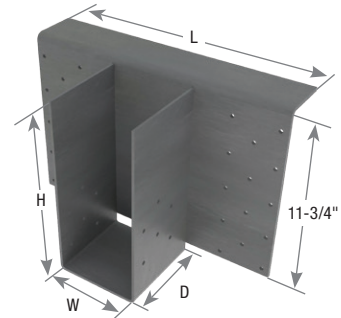
**Codes:** See page 12 for Code Reference Chart

**Installation:**

- Use all specified fasteners.
- WS3 Wood Screws, 1/4" dia. x 3" long, are supplied with KEGQ hangers.
- **Minimum header height (H) is 11-7/8".**
- Beam height dimension (H) must be specified when ordering.



**Typical KEGQ550 installation**



**KEGQ**

Joist / Purlin Size	MiTek USP Stock No.	Ref. No	Steel Ga.		Dimensions (in)				Fastener Schedule <sup>3</sup>				DF/SP Allowable Loads (Lbs.)				Code Ref.
			Top Flange	U-Strap	W	H <sup>2</sup>	D	L	Header		Joist		Download		Uplift <sup>1</sup>		
									Qty	Type	Qty	Type	100%	115%	125%	160%	
3-1/2	<b>KEGQ362</b>	EGQ3.62-SDS3	3	7	<b>3-5/8</b>	specify	6	18	28	WS3	12	WS3	17750	17750	17750	5020	IBC, FL, LA
5-1/4	KEGQ550	EGQ5.25-SDS3	3	7	5-1/2	specify	6	18	28	WS3	12	WS3	17750	17750	17750	7430	
7	KEGQ725	EGQ7.25-SDS3	3	7	7-1/4	specify	6	18	28	WS3	12	WS3	17750	17750	17750	7430	

- 1) Uplift loads have been increased 60% for wind and seismic loads; no further increase shall be permitted.
  - 2) "Specify" denotes the required supported beam height that must be specified at the time of ordering, with 11" being the minimum.
  - 3) WS3 Wood Screws are 1/4" dia. x 3" long and are included with KEGQ hangers.
- New products or updated product information are designated in **blue font**.

# KEG / KLEG / KMEG Bolted Glulam Beam Hangers

Bolt-only fastening, heavy steel construction, and a continuous top flange allow the KLEG, KMEG, and KEG products to have high load capacities.

**KLEG** – (4) bolt light-duty hanger.

**KMEG** – (6) bolt medium-duty hanger.

**KEG** – (8) bolt heavy-duty hanger.

**Materials:** See chart

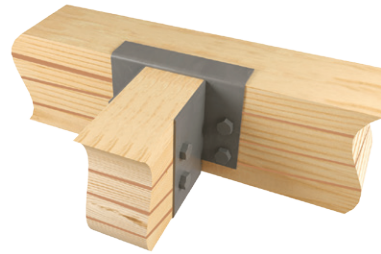
**Finish:** Primer

**Options:** See Specialty Options Chart.

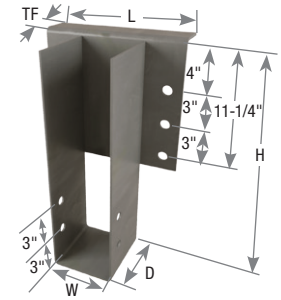
**Codes:** See page 12 for Code Reference Chart

**Installation:**

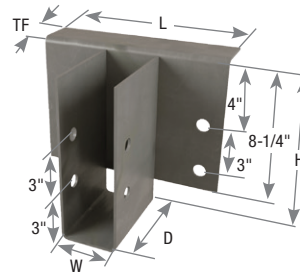
- Use all specified fasteners. See Product Notes, page 20.
- **Minimum header height is 10" for the KLEG; 13" for the KMEG; 20" for the KEG.**
- Beam height dimension (H) must be specified when ordering.



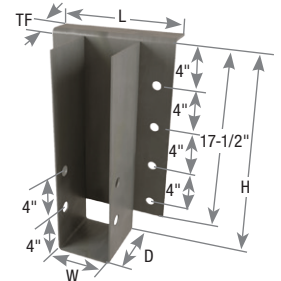
**Typical KLEG5 installation**



**KMEG5**



**KLEG3**



**KEG5**

Beam Width (in)	MiTek USP Stock No.	Ref. No.	Steel Ga.		Dimensions (in)					Bolt Schedule				Allowable Loads (Lbs.)					Code Ref.
			Top Flange	U-Strap	W	H <sup>3</sup>	D	TF	L	Header		Joist		With Top Flange <sup>1</sup>		Without Top Flange <sup>1</sup>		Uplift	
										Qty	Dia (in)	Qty	Dia (in)	Floor	Roof	Floor	Roof		
3-1/8	KLEG3	LEG3	7	7	3-1/4	specify	6	2-1/2	12	4	3/4	2	3/4	11980	12165	3580	4470	3845	IBC, FL, LA
5-1/8	KLEG5	LEG5	7	7	5-1/4	specify	6	2-1/2	12	4	3/4	2	3/4	11980	12165	3580	4470	4690	
	KMEG5	MEG5	7	7	5-1/4	specify	6	2-1/2	12	6	3/4	2	3/4	12635	12635	5345	6685	4690	
6-3/4	KEG5	EG5	3	7	5-1/4	specify	6	2-1/2	12	8	1	2	1	17615	19920	9215	11520	7305	
	KLEG7	LEG7	7	7	6-7/8	specify	6	2-1/2	12	4	3/4	2	3/4	11980	12165	3580	4470	4690	
	KMEG7	MEG7	7	7	6-7/8	specify	6	2-1/2	12	6	3/4	2	3/4	12635	12635	5345	6685	4690	
8-3/4	KEG7	EG7	3	7	6-7/8	specify	6	2-1/2	13-1/2	8	1	2	1	18695	21005	9245	11555	9275	
	KEG9	EG9	3	7	8-7/8	specify	6	2-1/2	15-1/2	8	1	2	1	20125	21045	9275	11595	9305	
10-3/4	KEG11	--	3	7	10-7/8	specify	6	2-1/2	17-1/2	8	1	2	1	21045	21045	9295	11620	9325	



**KLEG without top flange**

1) Allowable loads are for a supporting member with a width of 5-1/2", and 560 psi perpendicular to grain loading in single shear.  
 2) Uplift loads have been increased 60% for wind and seismic loads; no further increase shall be permitted.  
 3) "Specify" denotes the required supported beam height that must be specified at the time of ordering.

**Specialty Options Chart**

– refer to Specialty Options pages 283 and 285-286 for additional details

Option	Skewed <sup>3</sup>	Sloped Seat	Top Flange Offset <sup>1,2</sup>
Range	1° to 45°	1° to 45°	--
Allowable Loads	KLEG – 10,000-lb Max KMEG – 10,000-lb Max KEG – 14,250-lb Max	KLEG – 9,665 lbs. Max KMEG – 9,665 lbs. Max KEG – 9,665 lbs. Max	KLEG – 5,665-lb Max KLEG – 9" Min Height KMEG – 5665 lbs. Max KMEG – 11" Min Height
Ordering	Add <i>SK</i> , angle required, right ( <i>R</i> ) or left ( <i>L</i> ), and square cut ( <i>SQ</i> ) to product number. Ex. KLEG3_H=112_SK45R_SQ	Add <i>SL</i> , slope required, and up ( <i>U</i> ) or down ( <i>D</i> ), to product number. Ex. KLEG3_H=112_SL30D	Add <i>OS</i> , and right ( <i>R</i> ) or left ( <i>L</i> ), to product number. Ex. KLEG3_H=112_OSL

1) Top flange offset hangers may not be skewed.  
 2) Top flange offset option is not available for KEG models.  
 3) Carried member must have square cut end on skewed option.  
 Refer to Typical HLBH hanger, skewed, left shown, Type B illustration on page 285.

# KGB / KHGB / KHHB Glulam Top Mount Hangers



These hangers cover medium-to-heavy glulam beam and purlin applications.

**KHHB** – Medium capacity hanger.

**KGB** – Medium-to-heavy capacity hanger.

**KHGB** – Heavy capacity hanger.

**Materials:** 7 gauge

**Finish:** Primer

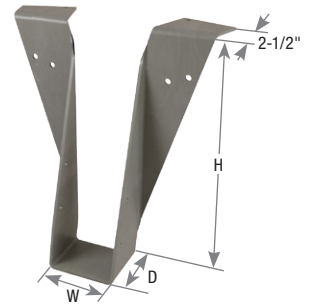
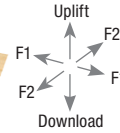
**Codes:** See page 12 for Code Reference Chart

**Installation:**

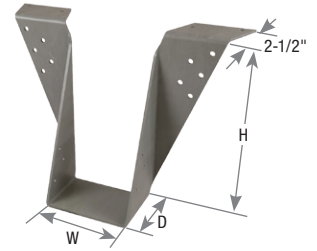
- Use all specified fasteners. See Product Notes, page 20.
- WS3 Wood Screws are supplied with hangers.
- Beam height dimension (H) must be specified when ordering.
- **Minimum height (H) is 7-1/2".**
- See Welded installation chart on page 287.



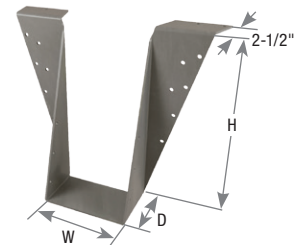
**Typical KHHB installation**



**KHHB**



**KGB**



**KHGB**

Beam Width (in)	MiTek USP Stock No.	Ref. No.	Dimensions (in) <sup>2</sup>			Fastener Schedule <sup>4</sup>					Allowable Loads (Lbs.)				Code Ref.
			W	H	D	Header <sup>3</sup>		Joist			F <sub>C</sub> = 625 psi			Uplift <sup>1</sup> 160%	
						Top Qty	Face Qty	Type	Qty	Type	Floor 100%	Roof			
												115%	125%		
3-1/8	KHHB3	--	3-1/4	specify	3	4	6	WS3	6	WS3	6480	6480	6480	2215	IBC, FL, LA
	KGB3	--			3-1/2	4	10	WS3	6	WS3	6480	6480	6480	2215	--
5-1/8	KHHB5	--	5-1/4	specify	3	4	6	WS3	6	WS3	6480	6480	6480	2215	IBC, FL, LA
	KGB5	--			3-1/2	4	10	WS3	6	WS3	6480	6480	6480	2215	
	KHGB5	--			4	4	12	WS3	6	WS3	6480	6480	6480	2215	
6-3/4	KHHB7	--	6-7/8	specify	3	4	6	WS3	6	WS3	6480	6480	6480	2215	IBC, FL, LA
	KGB7	--			3-1/2	4	10	WS3	6	WS3	6480	6480	6480	2215	
	KHGB7	--			4	4	12	WS3	6	WS3	6480	6480	6480	2215	

1) Uplift loads have been increased 60% for wind or seismic loads; no further increase shall be permitted.  
 2) "Specify" denotes the required supported beam height must be specified at the time of ordering.  
 3) Supporting header shall be no less than 3" thick.  
 4) WS3 Wood Screws are 1/4" dia. x 3" long and are included with hangers.

# KGLT / KHGLT Glulam Beam Hangers



These heavy beam hangers are designed for use with glulam and timber beams. The continuous top mount flange offers high load capacity with minimal fastening.

**KGLT** – Medium capacity hanger.

**KHGLT** – Heavy capacity hanger.

**Materials:** See chart

**Finish:** Primer

**Options:** See Specialty Options Chart

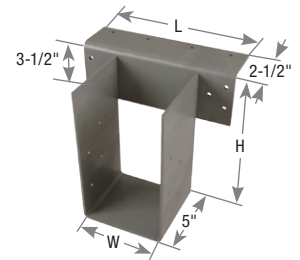
**Codes:** See page 12 for Code Reference Chart

**Installation:**

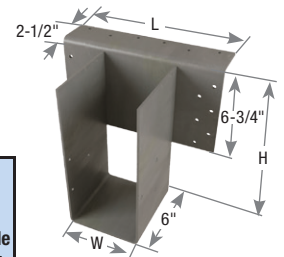
- Use all specified fasteners. See Product Notes, page 20.
- Beam height dimension (H) must be specified when ordering.
- See Welded installation chart on page 287.



**Typical KGLT5 installation**



**KGLT**



**KHGLT**

Beam Width (in)	MiTek USP Stock No.	Ref. No.	Steel Gauge		Dimensions (in)			Fastener Schedule <sup>5</sup>					Allowable Loads (Lbs.) <sup>2</sup>				Code Ref.
			Top Flange	U-Strap	W	H <sup>4</sup>	L	Header			Joist		Floor	Roof		Uplift <sup>1</sup>	
								Top Qty	Face Qty	Type	Qty	Type		100% <sup>3</sup>	115%		
3-1/8	KGLT3	--	3	7	3-1/4	specify	10	4	6	WS3	8	WS3	10555	10965	11055	1925	IBC, FL, LA
	KHGLT3	HGLT3					12	6	12	WS3	6	WS3	12495	12495	12495	1925	
3-1/2	KGLT4	--	3	7	3-5/8	specify	10	4	6	WS3	8	WS3	10555	10965	11055	1925	
	KHGLT4	HGLT4, HGLTV4					12	6	12	WS3	6	WS3	12495	12495	12495	1925	
5-1/8	KGLT5	--	3	7	5-1/4	specify	10	4	6	WS3	8	WS3	10555	10965	11055	1925	
	KHGLT5	HGLT5, HGLTV5					12	6	12	WS3	6	WS3	12495	12495	12495	1925	
5-5/16	KHGLT537	HGLTV5.37	3	7	5-3/8	specify	12	6	12	WS3	6	WS3	12495	12495	12495	1925	
5-1/2	KGLT6	--	3	7	5-5/8	specify	12	4	6	WS3	8	WS3	10555	10965	11055	1925	
	KHGLT6	HGLT6, HGLTV6					12	6	12	WS3	6	WS3	12495	12495	12495	1925	
6-3/4	KGLT7	--	3	7	6-7/8	specify	12	4	6	WS3	8	WS3	10555	10965	11055	1925	
	KHGLT7	HGLT7, HGLTV7					12	6	12	WS3	6	WS3	12495	12495	12495	1925	
8-3/4	KGLT9	--	3	7	8-7/8	specify	14	4	6	WS3	8	WS3	10555	10965	11055	1925	
	KHGLT9	HGLT9					14	6	12	WS3	6	WS3	12495	12495	12495	1925	
10-3/4	KHGLT11	--	3	7	10-7/8	specify	16	6	12	WS3	6	WS3	12495	12495	12495	1925	

- 1) Uplift loads have been increased 60% for wind or seismic loads; no further increase shall be permitted.
- 2) KGLT load values based on 460 psi perpendicular to grain loading. KHGLT load values based on 625 psi perpendicular to grain loading.
- 3) No further increase for duration of load allowed.
- 4) "Specify" denotes the required supported beam height that must be specified at time of ordering, with 7-1/2" being the minimum.
- 5) WS3 Wood Screws are 1/4" dia x 3" long and are included with hangers.

**KGLT Nailer Options**

– chart represents maximum allowable loads for hangers used on wood nailers. Reference page 183.

MiTek USP Series	Nailer Size	Fastener Schedule <sup>2,3</sup>				DF/SP		SPF	
		Nailer		Joist		Allowable Loads (Lbs.) <sup>1</sup>		Allowable Loads (Lbs.) <sup>1</sup>	
		Qty	Type	Qty	Type	100%	Uplift 160%	100%	Uplift 160%
KGLT	2x	4	WS15	8	WS15	5210	--	4375	--
	3x	6	WS15	8	WS15	6655	--	5590	--
	(2) 2x	8	WS3	8	WS3	6430	--	5400	--
	4X	10	WS3	8	WS3	6040	<b>1925</b>	5075	<b>1615</b>

- 1) Listed loads shall not be increased.
- 2) WS15 Wood Screws are 1/4" dia. x 1-1/2" long and are not included with hangers.
- 3) WS3 Wood Screws are 1/4" dia. x 3" long and are included with hangers. New products or updated product information are designated in blue font.

**Specialty Options Chart**

– refer to Specialty Options pages 283 and 285-286 for additional details

Option	Skewed <sup>1,3</sup>	Sloped Seat <sup>2,3</sup>	Sloped / Skewed <sup>1,2,3</sup>	Sloped Top Flange <sup>4</sup>	Top Flange Offset	Saddle
Range	1° to 50°	1° to 45°	See Sloped Seat and Skewed	0° to 45°	--	--
Allowable Loads	50% of uplift load on skew greater than 15°	KGLT – 4,110-lb Max KHGLT – 7,000-lb Max	50% of uplift load on skew greater than 15°	100% of table load	60% of table load for KGLT. 45% of table load for KHGLT.	100% of table load per side
Ordering	Add <i>SK</i> , angle required, right ( <i>R</i> ) or left ( <i>L</i> ), and square cut ( <i>SQ</i> ) or bevel cut ( <i>BV</i> ) to product number. Ex. KGLT3_H=16_SK45R_BV	Add <i>SL</i> , slope required, and up ( <i>U</i> ) or down ( <i>D</i> ), to product number. Ex. KGLT3_H=16_SL30D	See Sloped Seat and Skewed. Ex. KGLT3_H=16_SK45R_BV_SL30D	Add <i>SF</i> , angle required and right ( <i>R</i> ) or left ( <i>L</i> ), to product number. Ex. KGLT3_H=16_SF30L	Add <i>OS</i> , and right ( <i>R</i> ) or left ( <i>L</i> ), to product number. Ex. KGLT3_H=16_OSL	Add <i>SA</i> , and saddle width required to product number. Ex. KGLT3_H=16_SA=5-1/2"

- 1) Skewed hangers with skews greater than 15° may have all joist nailing on outside flange.
- 2) Sloped or sloped / skewed hangers with slopes greater than 15° may have additional joist nails.
- 3) Skewed hangers typically require a bevel cut however, a square cut option may be available as a custom when requested.
- 4) Sloped top flanges with slopes greater than 15° may have additional header nails.

Supports a glulam beam off of another glulam beam. Refer to the Optional Horizontal Loading Chart for design variations.

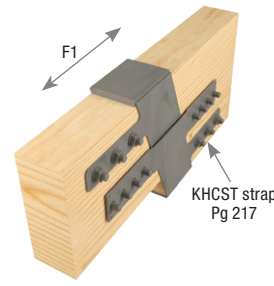
**Materials:** See chart

**Finish:** Primer

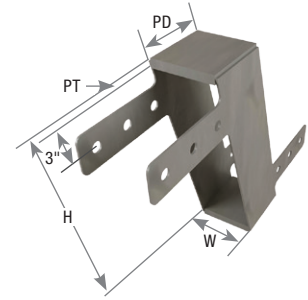
**Codes:** See page 12 for Code Reference Chart

**Installation:**

- Use all specified fasteners. See Product Notes, page 20.
- To allow for wood shrinkage, position bolts in slots away from the bearing seat.
- For dapped beams, reduce the “H” dimension by the “PT” dimension for each dap.



Typical KHC installation



KHC3

**Optional Horizontal Loading Chart**

MiTek USP Stock No. Prefix	Ref. No.	Min. H <sup>3</sup> (in)	Rotation Bolts <sup>2</sup> /Beam		Seismic Bolts <sup>2</sup>		DF/SP Allowable Loads (Lbs.) <sup>1</sup>
			Qty	Dia (in)	Qty	Dia (in)	F1 160%
* KHC	HCA	8	2	3/4	--	--	--
* KHC2T	--	9	2	3/4	2	3/4	--
KHC2CT	--	12	2	3/4	2	3/4	9445
KHCCT	HCCTA	12	2	3/4	3	3/4	14170
KHC4CT	--	12	2	3/4	4	3/4	18895
* KHC3	HC3A	8	3	3/4	--	--	--
* KHC3T	--	9	3	3/4	2	3/4	--
KHC2C3T	--	12	3	3/4	3	3/4	9445
KHCC3T	--	12	3	3/4	3	3/4	14170
KHC4C3T	HC4C3TA	12	3	3/4	4	3/4	18895

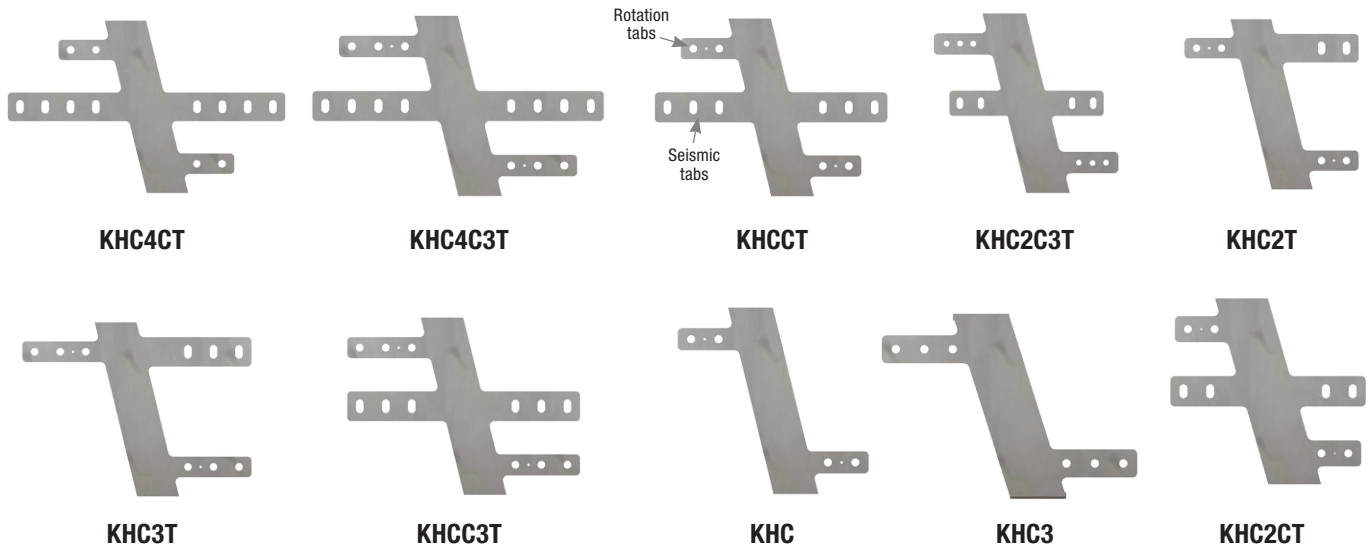


KHC3 side view



KHC3 top view

- 1) Loads are based on a 5-1/8" width Douglas-Fir Larch beam.
  - 2) All bolts are 3/4", and shall meet or exceed the specifications of ASTM A 307.
  - 3) Minimum H may be less than H required for listed loads; in which case, load reductions are required.
- \* When used with optional KHCST Seismic Strap, the minimum H is 12".





**Allowable Download Chart**

Beam Width (in)	MiTek USP Stock No. Suffix	Ref. No.	Steel Gauge	Dimensions (in)			(2) Rotation Bolts <sup>3</sup> Per Beam			(3) Rotation Bolts <sup>3</sup> Per Beam			Code Ref.
				W	PD	PT	H <sup>2</sup> (in)	DF/SP Allowable Loads (Lbs.) <sup>1</sup>		H <sup>2</sup> (in)	DF/SP Allowable Loads (Lbs.) <sup>1</sup>		
								410 psi	560 psi		410 psi	560 psi	
5-1/8	55	HCA5-5	7	5-1/4	5	3/4	17-1/2	10505	14350	14	10505	14350	IBC, FL, LA
	56	HCA5-6	7	5-1/4	6	3/4	22-3/4	12610	17220	17-1/2	12610	17220	
	57	HCA5-7	7	5-1/4	7	3/4	28-3/4	14710	20090	21-3/4	14710	20090	
	59	HCA5-9	7	5-1/4	9	3/4	43-1/2	18910	25830	32	18910	25830	
6-3/4	75	HCA7-5	7	6-7/8	5	1	20-3/4	13840	18900	16	13840	18900	
	76	HCA7-6	7	6-7/8	6	1	27-1/2	16605	22680	20-3/4	16605	22680	
	77	HCA7-7	7	6-7/8	7	1	35-1/2	19375	26460	26-1/4	19375	26460	
	79	HCA7-9	7	6-7/8	9	1	55	24910	34020	40	24910	34020	
8-3/4	95	HCA9-5	7	8-7/8	5	1-1/4	24-3/4	17940	24500	18-3/4	17940	24500	
	96	HCA9-6	7	8-7/8	6	1-1/4	33-1/2	21525	29400	24-3/4	21525	29400	
	97	HCA9-7	7	8-7/8	7	1-1/4	43-3/4	25115	34300	32	25115	34300	
	99	HCA9-9	7	8-7/8	9	1-1/4	69-1/4	32290	44100	49-3/4	32290	44100	
10-3/4	115	HCA11-5	3	10-7/8	5	1-1/2	27-1/4	22040	30100	20-1/4	22040	30100	
	116	HCA11-6	3	10-7/8	6	1-1/2	37-1/4	26445	36120	27	26445	36120	
	117	HCA11-7	3	10-7/8	7	1-1/2	49-1/4	30855	42140	35-1/4	30855	42140	
	119	HCA11-9	3	10-7/8	9	1-1/2	78-1/4	39670	54180	55-1/4	39670	54180	

- 1) Allowable loads shall not be further increased for duration.
- 2) The minimum height is for loads shown. For heights less than the minimum shown reduce the allowable loads in direct proportion.
- 3) All bolts are 3/4", and shall meet or exceed the specifications of ASTM A 307.

**KHCST / KHCSTR** Seismic Straps

Seismic straps can be installed during construction or added as a retrofit item.

**Materials:** See chart

**Finish:** Primer

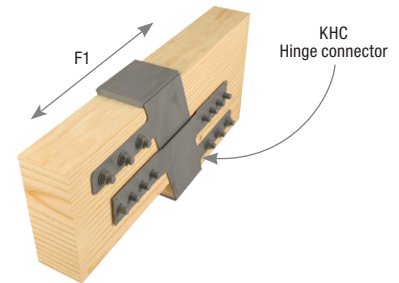
**Codes:** See page 12 for Code Reference Chart

**Installation:**

- Use all specified fasteners. See Product Notes, page 20.

MiTek USP Stock No. <sup>3</sup>	Ref. No.	Steel Gauge	Dimensions (in)		Bolt Schedule		DF/SP Allowable Loads (Lbs.) <sup>1,2</sup>	Code Ref.
			W	L	Qty	Dia (in)		
KHCST2	--	7	3-1/2	25-5/8	4	3/4	10075	IBC, FL, LA
KHCSTR2	HCSTR2							
KHCST3	--	7	3-1/2	31-5/8	6	3/4	14685	
KHCSTR3	HCSTR3							
KHCST4	--	3	3-1/2	37-5/8	8	3/4	20145	
KHCSTR4	HCSTR4							

- 1) Allowable loads are for straps used in pairs, and are increased 60% for wind or seismic loads; no further increase shall be permitted.
- 2) Loads are based on a 5-1/8" width Douglas-Fir-Larch beam.
- 3) Seismic straps shall be used with the KHC hinge connectors.



Typical KHCST installation



KHCST

# KGLS / KGLST / KHGLS / KHGLST Glulam Saddle Hangers



**KGLS** – Saddle hanger.

**KGLST** – Saddle hanger with seismic straps.

**KHGLS** – Heavier version of KGLS.

**KHGLST** – Heavier version of KGLST.

**Materials:** Top flange - 3 gauge; Stirrup - 7 gauge

**Finish:** Primer

**Options:** See KGLS / KHGLS Specialty Options Chart

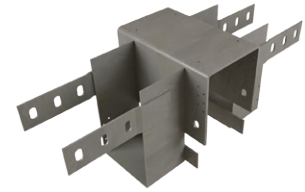
**Codes:** See page 12 for Code Reference Chart

**Installation:**

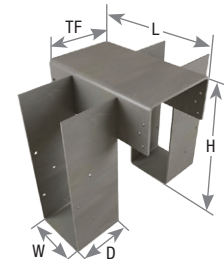
- Use all specified fasteners. See Product Notes, page 20.
- Loads and nail schedule apply to each saddle hanger stirrup.
- **Minimum header height is 8-1/2" for the KGLS; 8-1/2" for the KGLST; 10-1/2" for the KHGLS, and 10-1/2" for the KHGLST.**
- Beam height dimension (H) must be specified when ordering.
- **KGLST and KHGLST** models include seismic straps which must be installed with (3) 3/4" thru-bolts in each supported member and (2) 3/4" thru-bolts into the supporting beams.
- See Welded installation chart on page 287.



Typical KHGLST installation



KHGLST



KGLS

Supported Glulam Beam Size (in)	MiTek USP Stock No.	Ref. No.	Dimensions (in) <sup>4</sup>					Fastener Schedule								Allowable Loads (Lbs.) <sup>1</sup>					Code Ref.
			W	H <sup>4</sup>	D	L	TF	Header				Joist				F <sub>c</sub> = 560 psi			Uplift 160%	Tension 160%	
								Wood Screws <sup>1,3</sup>		Bolts		Wood Screws <sup>1,3</sup>		Bolts		Floor	Roof				
								Qty	Type	Qty	Dia (in)	Qty	Type	Qty	Dia (in)		100%	115%			
3-1/8	KGLS35	GLS3-5	3-1/4	specify	5	6	5-1/4	6	WS3	--	--	6	WS3	--	--	11070	11420	11650	2320	--	IBC, FL, LA
	KGLST35	--	3-1/4		6-1/2	10	5-1/4	6	WS3	2	3/4	6	WS3	3	3/4	13695	14045	14275	2320	15310	
	KGLS37	GLS3-7	3-1/4		5	6	6-7/8	6	WS3	--	--	6	WS3	--	--	11070	11420	11650	3715	--	
	KGLST37	--	3-1/4		6-1/2	10	6-7/8	6	WS3	2	3/4	6	WS3	3	3/4	13695	14045	14275	3715	15310	
	KGLS39	GLS3-9	3-1/4		5	6	8-7/8	6	WS3	--	--	6	WS3	--	--	11070	11420	11650	3715	--	
5-1/8	KGLST39	--	3-1/4	6-1/2	10	8-7/8	6	WS3	2	3/4	6	WS3	3	3/4	13695	14045	14275	3715	15310		
	KGLS55	GLS5-5	5-1/4	specify	5	9	5-1/4	6	WS3	--	--	6	WS3	--	--	15655	16065	16340	3715	--	
	KGLST55	--	5-1/4		6-1/2	12	5-1/4	6	WS3	2	3/4	6	WS3	3	3/4	19960	20370	20645	3715	15310	
	KGLS57	GLS5-7	5-1/4		5	9	6-7/8	6	WS3	--	--	6	WS3	--	--	16670	17020	17250	3715	--	
	KGLST57	--	5-1/4		6-1/2	12	6-7/8	6	WS3	2	3/4	6	WS3	3	3/4	20975	21325	21555	3715	15310	
KHGLS5	HGLS5	5-1/4	6-1/2		12	specify	14	WS3	--	--	8	WS3	--	--	21750	22215	22525	4955	--		
6-3/4	KHGLST5	--	5-1/4	6	12	specify	14	WS3	2	3/4	8	WS3	3	3/4	20315	20780	21090	4955	15310		
	KGLS77	GLS7-7	6-7/8	specify	5	12	6-7/8	6	WS3	--	--	6	WS3	--	--	21220	21570	21800	3715	--	
	KGLST77	--	6-7/8		6-1/2	12	6-7/8	6	WS3	2	3/4	6	WS3	3	3/4	25420	25830	26105	3715	15310	
	KGLS79	GLS7-9	6-7/8		5	12	8-7/8	6	WS3	--	--	6	WS3	--	--	21220	21570	21800	3715	--	
	KGLST79	--	6-7/8		6-1/2	12	8-7/8	6	WS3	2	3/4	6	WS3	3	3/4	26890	27240	27470	3715	15310	
KHGLS7	HGLS7	6-7/8	6		12	specify	14	WS3	--	--	8	WS3	--	--	23195	24155	24795	4955	--		
8-3/4	KHGLST7	--	6-7/8	6-1/2	14	specify	14	WS3	2	3/4	8	WS3	3	3/4	25995	26955	27595	4955	15310		
	KHGLS9	HGLS9	8-7/8	specify	6	12	specify	14	WS3	--	--	8	WS3	--	--	23195	24155	24795	4955	--	
	KHGLST9	--	8-7/8		6-1/2	16	specify	14	WS3	2	3/4	8	WS3	3	3/4	28975	29755	30395	4955	15310	

- 1) Allowable loads and fastener schedules apply to each side of the saddled hanger.
- 2) Minimum header height is 8-1/2" for the KGLS and KGLST; 10-1/2" for the KHGLS and KHGLST.
- 3) WS3 Wood Screws are 1/4" dia. x 3" long and are included with hangers.
- 4) Hangers with seismic straps may require a minimum joist depth. Consult MiTek for additional information.

**KGLS / KHGLS Specialty Options Chart** – refer to Specialty Options pages 283 and 285-286 for additional details

Option	Skewed <sup>1,3</sup>	Sloped Seat <sup>2</sup>	Sloped / Skewed <sup>1,2</sup>	Sloped Top Flange <sup>4</sup>	Top Flange Offset	Saddle
Range	1° to 50°	1° to 45°	See Sloped Seat and Skewed	0° to 30°	May not be skewed	5" minimum saddle
Allowable Loads	KGLS – 6,500-lb Max KHGLS – 7,980-lb Max 50% of uplift load on skews greater than 15°.	KGLS – 6,500-lb Max KHGLS – 9,165-lb Max	KGLS – 5,500-lb Max <b>KHGLS – may not be sloped / skewed.</b>	100% of table load	50% of table load for KGLS. 45% of table load for KHGLS.	100% of table load per side
Ordering	Add SK, angle required, right (R) or left (L), and square cut (SQ) or bevel cut (BV) to product number. Ex. KGLS35H115_SK45R_BV	Add SL, slope required, and up (U) or down (D), to product number. Example: KGLS35H115_SL30D	See Sloped Seat and Skewed. Example: KGLS35H115_SK45R_BV_SL30D	Add SF, angle required, and right (R) or left (L), to product number. Example: KGLS35H115_SF30L	Add OS, and right (R) or left (L), to product number. Example: KGLS35H115_OL	Add SA, and saddle width required to product number. Example: KGLS35H115_SA=5-1/2"

- 1) Skewed hangers with skews greater than 15° may have all joist nailing on outside flange.
- 2) Sloped or sloped / skewed hangers with slopes greater than 15° may have additional joist nails.
- 3) Skewed hangers typically require a bevel cut however, a square cut option may be available as a custom when requested.
- 4) Sloped top flanges with greater than 15° may have additional header nails.

# NOP Moisture Barrier Plates

Moisture Barrier Plates protect the bottom chords of trusses from moisture damage caused by direct contact with concrete. These plates eliminate the need for more expensive treated wood plates.

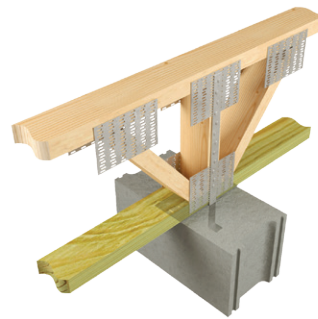
**Materials:** See chart

**Finish:** G90 galvanizing

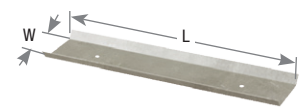
**Codes:** See page 12 for Code Reference Chart

**Installation:**

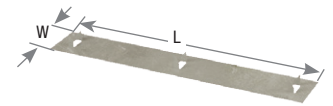
- Use all specified fasteners. See Product Notes, page 20.
- Pre-attach to truss bottom chord or rafter using pre-punched prongs and/or 6d common nails to prevent wood-to-concrete contact.



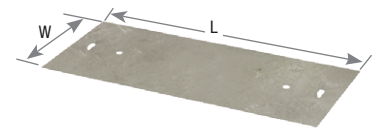
Typical NOP4 installation



NOP1



NOP2X



NOP4

Truss & Rafter

Size	MiTek USP Stock No.	Ref. No.	Steel Gauge	Dimensions (in)		Fastener Schedule <sup>1</sup>		Code Ref.
				W	L	Qty	Type	
2x	NOP2X	TSS2, TBP8	26	1-7/16	8	--	--	--
	NOP1	--	22	1-1/2	8	2	6d	
4x	NOP4	TSS2-2	26	3-1/2	8	2	6d	

1) Nails: 6d nails are 0.120" dia. x 2" long.

## LPTA Embedded Truss Anchors

Low profile design attaches to 2x4 or larger bottom chords and provides uplift and lateral load resistance.

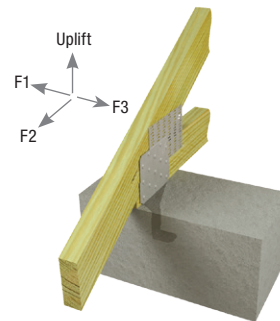
**Materials:** 18 gauge

**Finish:** G90 galvanizing

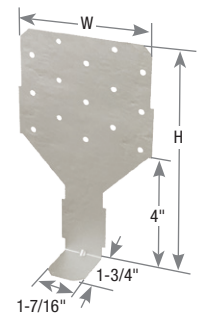
**Codes:** See page 12 for Code Reference Chart

**Installation:**

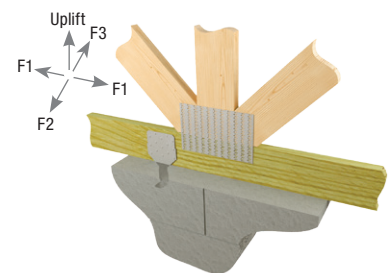
- Use all specified fasteners. See Product Notes, page 20.
- Embed LPTA 4" into concrete tie beam or masonry bond beam.
- Anchors should be spaced no closer than 8" center-to-center.
- **Moisture barrier may be required.**



Typical LPTA perpendicular installation



LPTA



Typical LPTA parallel installation

MiTek USP Stock No.	Ref. No.	Steel Gauge	Dimensions (in)		Load Direction to Wall Installation	Fastener Schedule <sup>5</sup>		DF/SP Allowable Loads (Lbs.) <sup>1,2</sup>				S-P-F Allowable Loads (Lbs.) <sup>1,2</sup>				Code Ref.
			W	H		Per Anchor		Uplift	F1	F2	F3	Uplift	F1	F2	F3	
						Min Qty. <sup>3,4</sup>	Type									
LPTA	LTA2	18	5	8-1/4	Perpendicular	10	10d x 1-1/2	1510	335	745	345	1510	280	745	345	FL
					Parallel			1470	750	1085	335	1470	750	975	280	

1) Allowable loads have been increased 60% for wind or seismic loads; no further increase shall be permitted.  
 2) Grout or concrete compressive strength shall be 2,500 psi or greater at 28 days.  
 3) Minimum quantity of fasteners to be installed. Product may have additional nail holes not needed to meet published allowable load of product.  
 4) The five nail holes nearest the embedment line must be filled to achieve the lateral loads listed in the table.  
 5) **NAILS:** 10d x 1-1/2 nails are 0.148" dia. x 1-1/2" long.

# HLPTA Embedded Truss Anchor



The HLPTA75 is designed and tested to provide higher lateral capacity and net uplift. Offers greater pullout resistance and is compatible with bond beam reinforcing.

**Materials:** 18 gauge

**Finish:** G90 galvanizing

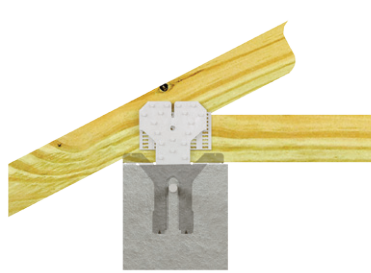
**Codes:** See page 12 for Code Reference Chart

**Patent:** #7,254,919

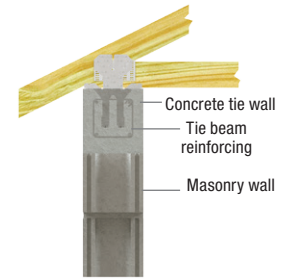
**Installation:**

- Use all specified fasteners. See Product Notes, page 20.
- Embed in concrete tie beam or masonry bond beam until the seat is resting on the surface.
- Minimum of one #7 rebar or two #5 rebars through the theoretical shear cone is required.
- Grout or concrete compressive strength shall be 2,500 psi at 28 days.
- Minimum spacing between anchors is 10" to achieve full design load capacities on single anchors.
- When used in a double rebar installation, concrete tie beam stirrup should be sized to accommodate connector leg placement.
- Designer shall verify connector clearance when using in conjunction with stirrups and two rebar applications.
- Verify grout is not in contact with truss member.

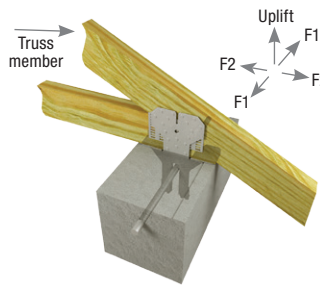
**Moisture barrier may be required.**



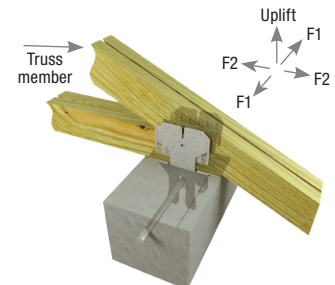
**Typical HLPTA75 single rebar installation**



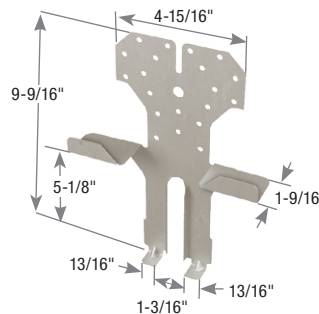
**Typical HLPTA75 double rebar installation**



**Typical HLPTA75 single anchor installation**



**Typical HLPTA75 double anchor installation**



**HLPTA75**

MiTek USP Stock No.	Ref. No.	Steel Gauge	Installation Type	Fastener Schedule <sup>2</sup>				DF/SP Allowable Loads (Lbs.) <sup>1</sup>			S-P-F Allowable Loads (Lbs.) <sup>1</sup>			Code Ref.
				Seat Plate		Truss/Rafter		Uplift 160%	F1 160%	F2 160%	Uplift 160%	F1 160%	F2 160%	
				Qty	Type	Qty	Type							
HLPTA75	--	18	Single Anchor	2	10d x 1-1/2	20	10d x 1-1/2	2125	1860	1715	2125	1860	1160	FL
			Double Anchor	--	--	40	10d x 1-1/2	3500	2040	2100	3500	2040	2100	--

1) Allowable loads have been increased 60% for wind and seismic loads; no further increase shall be permitted.

2) **NAILS:** 10d x 1-1/2 nails are 0.148" dia. x 1-1/2" long.

HTA – 16 or 18 gauge

HTAR – 16 or 18 gauge with attached moisture barrier.

HHTA – 14 gauge

**Materials:** See chart

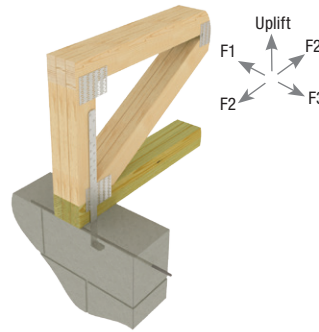
**Finish:** G90 galvanizing

**Options:** See chart for Corrosion Finish Options

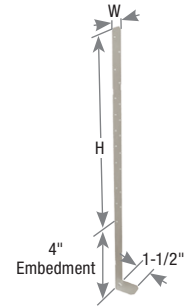
**Codes:** See page 12 for Code Reference Chart

**Installation:**

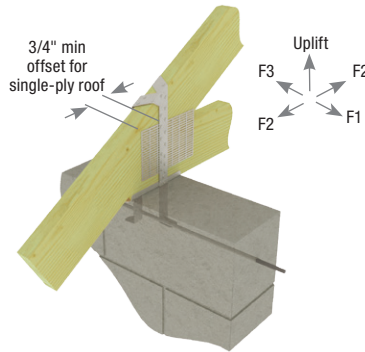
- Use all specified fasteners. See Product Notes, page 20.
- Embed 4" into concrete tie beam or masonry bond beam.
- **For double anchor installations:** anchors should be installed on opposite sides of wood member and offset a minimum 3/4" from each other in bond beam or concrete tie beam.
- Designer may specify alternative nailing schedules. Refer to [Nail Specification table on page 23](#) for nail shear values, load values shall not exceed published allowable loads.
- When using alternative nailing schedules, lower-most holes in strap shall be filled progressing upward towards the top of the strap.
- Straps may be installed straight or wrapped over to achieve table loads.
- Moisture barrier will be required in HTA / HHTA unless another moisture remediation method is used.



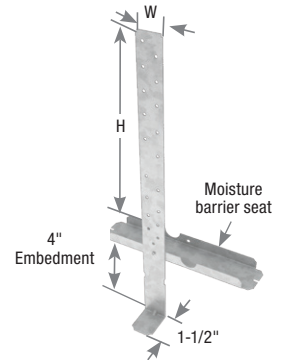
**Typical HTA24-18 single anchor installation**



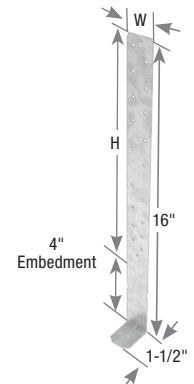
**HTA24-18**



**Typical HTA16 double anchor installation**



**HTA16R**

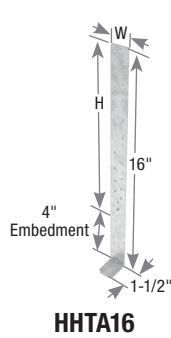


**HHTA16**

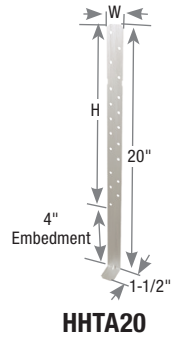
MiTek USP Stock No.	Ref. No.	GA	Dimensions (in)		Fastener Schedule		Installation Type <sup>8</sup>	SP Allowable Loads (Lbs.) <sup>1,2,3,4,5</sup>							Code Ref.
			W	H <sup>7</sup> (Out of Concrete)	Per Anchor			Masonry		Concrete		Lateral Loads			
					Min Qty. <sup>6</sup>	Type <sup>9</sup>		1 Ply	2 Ply	1 Ply	2 Ply	Masonry/Concrete (1 or 2 Ply)			
								Uplift 160%	Uplift 160%	Uplift 160%	Uplift 160%	F1 160%	F2 160%	F3 160%	
HTA12	HETA12	16	1-1/4	8	9	10d x 1-1/2	Single Anchor	1870	1870	1870	1870	270	710	945	FL
							Double Anchor	2430	2430	2430	2430	1215	1310	1215	
HTA12R	HETA12-TSS2						Single Anchor	1870	1870	1870	1870	270	710	945	
							Double Anchor	2430	2430	2430	2430	1215	1310	1215	
HTA12-2R	HETA12-TSS2-2						Single Anchor	1870	1870	1870	1870	270	710	945	
							Double Anchor	2430	2430	2430	2430	1215	1310	1215	

1) Allowable loads have been increased 60% for wind or seismic loads; no further increase shall be permitted.  
 2) Allowable loads are based on anchorage to masonry/uncracked concrete.  
 3) DF Allowable Loads are identical to all SP Allowable Loads listed in the chart with the exception of the HTA single anchor installation type uplift allowable load which is limited to 1730 lbs. in both masonry and concrete.  
 4) Minimum specified masonry or concrete compressive strength, f'm is 1,500 psi and f'c is 2,500 psi at 28 days respectively.  
 5) Allowable loads require a No. 4 rebar through the shear cones of the anchors.

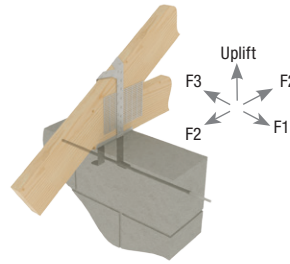
6) Minimum quantity of fasteners to be installed. Product may have additional nail holes not needed to meet published allowable load of product.  
 7) Height (H) is the distance the anchor extends out of concrete or masonry.  
 8) **Double anchor installation is permitted on 1-ply roof members when anchors are offset from each other a minimum of 3/4". Do not install anchors directly back-to-back or nails will interfere with each other.**  
 9) **NAILS:** 10d x 1-1/2" nails are 0.148" dia. x 1-1/2" long.  
 New products or updated product information are designated in **blue font**.



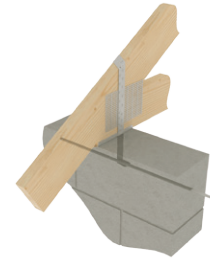
HHTA16



HHTA20



Typical HHTA20  
double roof-truss installation



Typical HHTA20  
single roof-truss installation

MiTek USP Stock No.	Ref. No.	GA	Dimensions (in)		Fastener Schedule		Installation Type <sup>8</sup>	SP Allowable Loads (Lbs.) <sup>1,2,3,4,5</sup>							Corrosion Finish	Code Ref.							
			W	H <sup>7</sup> (Out of Concrete)	Per Anchor			Masonry		Concrete		Lateral Loads											
					Min Qty. <sup>6</sup>	Type <sup>9</sup>		1 Ply	2 Ply	1 Ply	2 Ply	Masonry/Concrete (1 or 2 Ply)											
								Uplift 160%	Uplift 160%	Uplift 160%	Uplift 160%	F1 160%	F2 160%	F3 160%									
HTA16-18	META12, META16	18	1-1/4	12	9	10d x 1-1/2	Single Anchor	1625	1625	1625	1625	250	570	835									
HTA16-18R	META16-TSS2						Double Anchor	2430	2430	2430	2430	1085	1140	1085									
HTA16	HETA16	16	1-1/4	12	9	10d x 1-1/2	Single Anchor	1870	1870	1870	1870	270	710	945									
HTA16R	HETA16-TSS2						Double Anchor	2430	2430	2430	2430	1215	1310	1215									
HTA16-2R	HETA16-TSS2-2						Single Anchor	1870	1870	1870	1870	270	710	945									
							Double Anchor	2430	2430	2430	2430	1215	1310	1215									
HHTA16	HHETA16						14	1-1/4	12	11	10d x 1-1/2	Single Anchor	2375	2375			2375	2375	270	710	945		
												Double Anchor	2650	2650			2650	2770	1215	1310	1215		
HTA20-18	META18, META20	18	1-1/4	16	9	10d x 1-1/2	Single Anchor	1625	1625	1625	1625	250	570	835									
HTA20-18R	META20-TSS2						Double Anchor	2430	2430	2430	2430	1085	1140	1085									
HTA20	HETA20	16	1-1/4	16	9	10d x 1-1/2	Single Anchor	1870	1870	1870	1870	270	710	945	FL								
HTA20R	HETA20-TSS2						Double Anchor	2430	2430	2430	2430	1215	1310	1215									
HTA20-2R	HETA20-TSS2-2						Single Anchor	1870	1870	1870	1870	270	710	945									
							Double Anchor	2430	2430	2430	2430	1215	1310	1215									
HHTA20	HHETA20						14	1-1/4	16	11	10d x 1-1/2	Single Anchor	2375	2375			2375	2375	270	710	945		
												Double Anchor	2650	2650			2650	2770	1215	1310	1215		
HTA24-18	META22, META24	18	1-1/4	20	9	10d x 1-1/2	Single Anchor	1625	1625	1625	1625	250	570	835									
HTA24-18R	META24-TSS2						Double Anchor	2430	2430	2430	2430	1085	1140	1085									
HTA24	HETA24	16	1-1/4	20	9	10d x 1-1/2	Single Anchor	1870	1870	1870	1870	270	710	945									
HTA24R	HETA24-TSS2						Double Anchor	2430	2430	2430	2430	1215	1310	1215									
HTA24-2R	HETA24-TSS2-2						Single Anchor	1870	1870	1870	1870	270	710	945									
							Double Anchor	2430	2430	2430	2430	1215	1310	1215									
HTA48R	--						16	1-1/4	42-1/2	9	10d x 1-1/2	Single Anchor	1870	1870			1870	1870	240	470	680		
HTA48-2R	HETA40-TSS2-2										10d x 1-1/2	Double Anchor	2430	2430			2430	2430	955	940	955		
							Single Anchor	1870	1870	1870	1870	240	470	680									
							Double Anchor	2430	2430	2430	2430	955	940	955									

- 1) Allowable loads have been increased 60% for wind or seismic loads; no further increase shall be permitted.
- 2) Allowable loads are based on anchorage to masonry/uncracked concrete.
- 3) DF Allowable Loads are identical to all SP Allowable Loads listed in the chart with the exception of the HTA single anchor installation type uplift allowable load which is limited to 1730 lbs. in both masonry and concrete.
- 4) Minimum specified masonry or concrete compressive strength, f'm is 1,500 psi and f'c is 2,500 psi at 28 days respectively.
- 5) Testing conducted and design values based on unreinforced masonry. Rebar in wall specified by others.
- 6) Minimum quantity of fasteners to be installed. Product may have additional nail holes not needed to meet published allowable load of product.
- 7) Height (H) is the distance the anchor extends out of concrete or masonry.
- 8) Double anchor installation is permitted on 1-ply roof members when anchors are offset from each other a minimum of 3/4". Do not install anchors directly back-to-back or nails will interfere with each other.
- 9) **NAILS:** 10d x 1-1/2 nails are 0.148" dia. x 1-1/2" long.

**Corrosion Finish**

- Stainless Steel
- Gold Coat
- HDG
- Triple Zinc

The DHTA embedded truss anchor series offer high uplift capacity with a two-strap design. The straps are attached to MiTek's NOP style plate which ensures proper placement of straps while also providing a moisture barrier between the top of the wall and the truss.

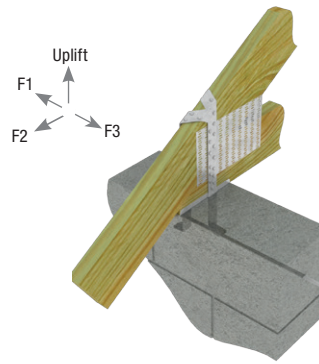
**Materials:** DHTA-18 – 18 gauge; DHTA – 16 gauge

**Finish:** G90 galvanizing

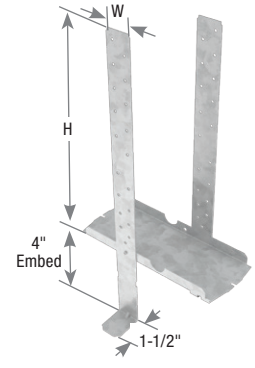
**Codes:** See page 12 for Code Reference Chart

**Installation:**

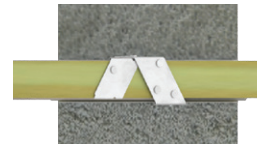
- Use all specified fasteners. See Product Notes, page 20.
- Embed 4" into concrete tie beam or masonry bond beam.
- Designer may specify alternative nailing schedules.
- When using alternative nailing schedules, lower-most holes in strap shall be filled progressing upward towards the top of the strap.
- Straps may be installed straight or wrapped over to achieve table loads.
- Moisture barrier plate may be under bent during shipping causing attached straps to be misaligned. Install straps vertically at 90° from the horizontal top surface of the wall.



**Typical DHTA 1-Ply installation**



**DHTA**



**DHTA 1-Ply plan view**  
(DHTA 2-Ply application similar)

MiTek USP Stock No.	Ref. No.	Steel Gauge	Dimension (in)		Fastener Schedule		No. of Pliers	SP Allowable Loads (Lbs.) <sup>1,2,3,4</sup>					Code Ref.
			W	H <sup>8</sup> (Out of Concrete)	Per Anchor			Uplift 160%		Lateral Loads <sup>5</sup>			
					Min Qty. <sup>6</sup>	Type <sup>9</sup>		Masonry	Concrete	F1 160%	F2 160%	F3 160%	
DHTA16-18	--	18	1-1/4	12	8	10d x 1-1/2	1 Ply	2430	2430	1085	1140	1085	FL
							2 Ply	2770	2770				
DHTA16-18-2	--	18	1-1/4	12	8	10d x 1-1/2	1 Ply	2430	2430	1085	1140	1085	
							2 Ply	2770	2770				
DHTA20-18	--	18	1-1/4	16	8	10d x 1-1/2	1 Ply	2430	2430	1085	1140	1085	
							2 Ply	2770	2770				
DHTA20-18-2	--	18	1-1/4	16	8	10d x 1-1/2	1 Ply	2430	2430	1085	1140	1085	
							2 Ply	2770	2770				
DHTA24-18	--	18	1-1/4	20	8	10d x 1-1/2	1 Ply	2430	2430	1085	1140	1085	
							2 Ply	2770	2770				
DHTA24-18-2	--	18	1-1/4	20	8	10d x 1-1/2	1 Ply	2430	2430	1085	1140	1085	
							2 Ply	2770	2770				
DHTA12	--	16	1-1/4	8	8	10d x 1-1/2	1 Ply	2430	2430	1215	1310	1215	
							2 Ply	2770	2770				
DHTA12-2	--	16	1-1/4	8	8	10d x 1-1/2	1 Ply	2430	2430	1215	1310	1215	
							2 Ply	2770	2770				
DHTA16	--	16	1-1/4	12	8	10d x 1-1/2	1 Ply	2430	2430	1215	1310	1215	
							2 Ply	2770	2770				
DHTA16-2	--	16	1-1/4	12	8	10d x 1-1/2	1 Ply	2430	2430	1215	1310	1215	
							2 Ply	2770	2770				
DHTA20	DETAL20	16	1-1/4	16	8	10d x 1-1/2	1 Ply	2430	2430	1215	1310	1215	
							2 Ply	2770	2770				
DHTA20-2	--	16	1-1/4	16	8	10d x 1-1/2	1 Ply	2430	2430	1215	1310	1215	
							2 Ply	2770	2770				
DHTA24	--	16	1-1/4	20	8	10d x 1-1/2	1 Ply	2430	2430	1215	1310	1215	
							2 Ply	2770	2770				
DHTA24-2	--	16	1-1/4	20	8	10d x 1-1/2	1 Ply	2430	2430	1215	1310	1215	
							2 Ply	2770	2770				
DHTA48	--	16	1-1/4	43	8	10d x 1-1/2	1 Ply	2430	2430	955	940	955	
							2 Ply						
DHTA48-2	--	16	1-1/4	43	8	10d x 1-1/2	1 Ply	2430	2430	955	940	955	
							2 Ply						

1) Allowable loads have been increased 60% for wind or seismic loads; no further increase shall be permitted.  
 2) Allowable loads are based on anchorage to masonry/uncracked concrete.  
 3) DF lumber may be substituted for SP with no load reduction.  
 4) Minimum specified masonry or concrete compressive strength, f'm is 1,500 psi and f'c is 2,500 psi at 28 days respectively.  
 5) The five nail holes nearest the embedment line must be filled to achieve the lateral loads listed in the table.  
 6) Minimum quantity of fasteners to be installed. Product may have additional nail holes not needed to meet published allowable load of product.  
 7) Install (8) nails into each anchor for the DHTA installation.  
 8) Height (H) is the distance the anchor extends out of concrete or masonry.  
 9) **NAILS:** 10d x 1-1/2 nails are 0.148" dia. x 1-1/2" long.

The DTC series attaches trusses to concrete or masonry walls. Innovative seat design gives added lateral resistance while still providing a moisture barrier.

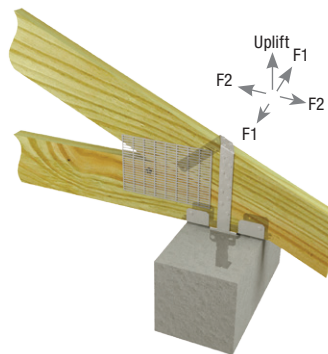
**Materials:** 16 gauge

**Finish:** G90 galvanizing

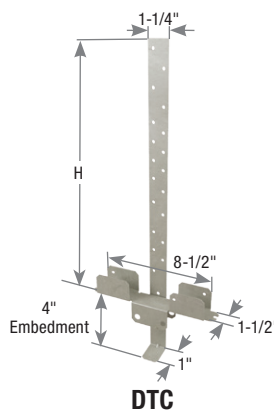
**Codes:** See page 12 for Code Reference Chart

**Installation:**

- Use all specified fasteners. See Product Notes, page 20.
- Embed 4" into concrete tie beam or masonry bond beam.
- Installations should be spaced no closer together than 8" center-to-center.
- Straps may be installed straight or wrapped over to achieve table loads.



**Typical DTC installation**



MiTek USP Stock No.	Ref. No.	Steel Gauge	Out of Concrete		Fastener Schedule <sup>4</sup>				DF/SP Allowable Loads (Lbs.) <sup>1,2,3</sup>				S-P-F Allowable Loads (Lbs.) <sup>1,2,3</sup>				Code Ref.
			H (in)	Seat Plate		Truss/Rafter		Uplift 160%	F1 160%		F2 160%	Uplift 160%	F1 160%		F2 160%		
				Qty	Type	Qty	Type		Toward Strap	Away from Strap			Toward Strap	Away from Strap			
																Qty	
DTC	HETAL12, HETAL16, HETAL20	16	16	4	10d x 1-1/2	9	10d x 1-1/2	1825	840	1200	1290	1440	840	1200	1290	FL	

1) Allowable loads have been increased 60% for wind and seismic loads; no further increase shall be permitted.  
 2) Grout or concrete compressive strength shall be 2500 psi or greater at 28 days.  
 3) Allowable loads require a No. 5 rebar through the shear cones of the anchors.  
 4) **NAILS:** 10d x 1-1/2 nails are 0.148" dia. x 1-1/2" long.



**TA** – Anchors are rated for both uplift and lateral loads. They can be installed straight or field-bent around truss or rafter members. An embossed embedment line assures accurate embedment depth.

**TAR** – Riveted anchors provide a moisture barrier in addition to uplift and lateral resistance all in one product.

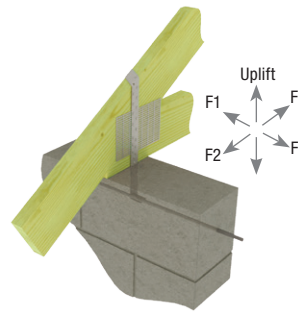
**Materials:** 14 gauge

**Finish:** G90 galvanizing

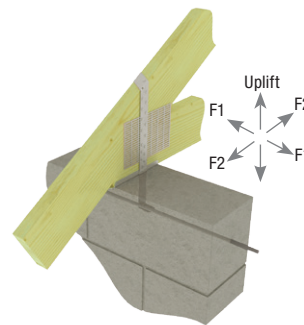
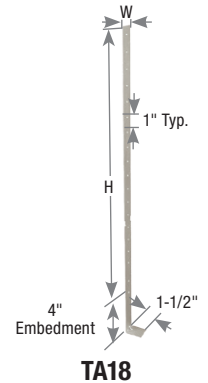
**Codes:** See page 12 for Code Reference Chart

**Installation:**

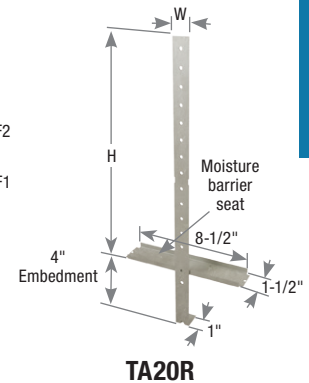
- Use all specified fasteners. See Product Notes, page 20.
- Embed 4" into concrete tie beam or masonry bond beam.
- **For double anchor installations:** anchors should be installed on opposite sides of wood member and offset a minimum 3/4" from each other in bond beam or concrete tie beam. See increased design values in chart below.
- Designer may specify alternative nailing schedules. Refer to Nail Specification table on page 23 for nail shear values, load values shall not exceed published allowable loads.
- When using alternative nailing schedules, lower-most holes in strap shall be filled progressing upward towards the top of the strap.
- Straps may be installed straight or wrapped over to achieve table loads.
- Moisture barrier will be required in installations unless another moisture remediation method is used.



**Typical TA18 installation**



**Typical TA16R installation**



MiTek USP Stock No. <sup>6</sup>	Ref. No.	Steel Gauge	Dimensions (in)		Fastener Schedule		SP Allowable Loads (Lbs.) <sup>1,2,3,4,5</sup>						Code Ref.
			W	H <sup>8</sup> (Out of Concrete)	Per Anchor		Single Anchor			Double Anchor <sup>9</sup>			
					Min Qty. <sup>7</sup>	Type <sup>11</sup>	Uplift 160% <sup>10</sup>	F1 160%	F2 160%	Uplift 160% <sup>10</sup>	F1 160%	F2 160%	
TA12	--	14	1	6-3/4	5	10d x 1-1/2	990	245	335	1980	490	670	--
TA14	--	14	1	8-3/4	7	10d x 1-1/2	1205	245	335	2410	490	670	
TA14R	--	14	1	8-3/4	7	10d x 1-1/2	1205	245	335	2410	490	670	
TA16	--	14	1	10-3/4	8	10d x 1-1/2	1205	245	335	2410	490	670	
TA16R	--	14	1	10-3/4	8	10d x 1-1/2	1205	245	335	2410	490	670	
TA18	--	14	1	12-3/4	8	10d x 1-1/2	1205	245	335	2410	490	670	
TA18R	--	14	1	12-3/4	8	10d x 1-1/2	1205	245	335	2410	490	670	
TA20	--	14	1	14-3/4	8	10d x 1-1/2	1205	245	335	2410	490	670	
TA20R	--	14	1	14-3/4	8	10d x 1-1/2	1205	245	335	2410	490	670	
TA22	--	14	1	16-3/4	8	10d x 1-1/2	1205	245	335	2410	490	670	
TA22R	--	14	1	16-3/4	8	10d x 1-1/2	1205	245	335	2410	490	670	
TA24	--	14	1	18-3/4	8	10d x 1-1/2	1205	245	335	2410	490	670	
TA24R	--	14	1	18-3/4	8	10d x 1-1/2	1205	245	335	2410	490	670	
TA36	--	14	1	30-3/4	8	10d x 1-1/2	1205	245	335	2410	490	670	

1) Allowable loads have been increased 60% for wind or seismic loads; no further increase shall be permitted.  
 2) Allowable loads are based on anchorage to masonry/uncracked concrete.  
 3) DF Allowable Loads are identical to all SP Allowable Loads listed in the chart.  
 4) Minimum specified masonry or concrete compressive strength, f'm is 1,500 psi and f'c is 2,500 psi at 28 days respectively.  
 5) Allowable loads require a No. 4 rebar through the shear cones of the anchors.  
 6) "R" after TA models indicates truss anchors with riveted moisture barrier as in TA12R.  
 7) Minimum quantity of fasteners to be installed. Product may have additional nail holes not needed to meet published allowable load of product.  
 8) Height (H) is the distance the anchor extends out of concrete or masonry.  
 9) Double anchor installation is permitted on 1-ply roof members when anchors are offset from each other a minimum of 3/4".  
 Do not install anchors directly back-to-back or nails will interfere with each other.  
 10) Allowable uplift capacity for TA models installed with (4) 10d x 1-1/2" nails is 780 lbs per anchor. Lateral loads do not apply.  
 11) **NAILS:** 10d x 1-1/2 nails are 0.148" dia. x 1-1/2" long.

# RFUS Uplift Girder Ties



The RFUS is a multi-purpose engineered solution for attaching trusses to concrete or masonry walls. Screw Anchor fastening eliminates mislocated cast-in-place anchor bolts and allows retrofit installations.

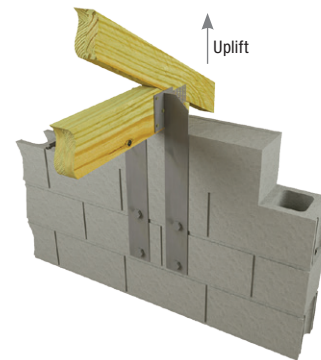
**Materials:** 10 gauge

**Finish:** Primer

**Codes:** See page 12 for Code Reference Chart

**Installation:**

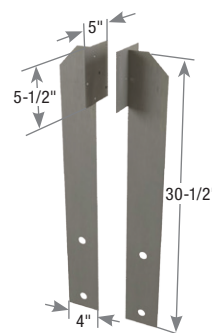
- Always install in pairs.
- Use all specified fasteners. See Product Notes, page 20.
- Designer shall be responsible for design of masonry structure, including any required reinforcement.
- For 1-ply applications, add filler block. Refer to page 257 for wood filler block installation.
- Moisture barrier may be required.



Typical RFUS installation

MiTek USP Stock No.	Ref. No.	Steel Gauge	No. of Plies <sup>6</sup>	Fastener Schedule <sup>5</sup>				DF/SP Allowable Loads (Lbs.)		Code Ref.
				Rafter/Truss		Concrete/Masonry <sup>4</sup>		Uplift 160% <sup>1</sup>	7100	
				Qty	Type <sup>7</sup>	Qty	Screw Anchor <sup>2,3</sup>			
RFUS	FGTR	10	≥ 2 Ply	12	WS3	4	3/4" x 6"		FL	

- 1) Uplift loads have been increased 60% for wind or seismic loads; no further increase shall be permitted.
- 2) Use DeWalt 3/4" x 6" Screw-Bolt™+; or equal, installed in accordance with manufacturer's specifications.
- 3) DeWalt 3/4" x 6" Screw-Bolt™+ are not supplied with RFUS ties. See page 34 for anchor information.
- 4) Fasteners shall be installed to fully grouted and reinforced concrete masonry or reinforced concrete (f'c = 2,500 psi at 28 days).
- 5) Fastener shedule is for two straps used together. The straps shall be installed in pairs.
- 6) Truss plies shall be fastened together to act as a unit.
- 7) WS3 Wood Screws are 1/4" dia. x 3" long and are supplied with RFUS connector.



RFUS

Truss & Rafter

**UGTS** – 2-screw anchor shorter design when space is limited.

**USC** – 4-screw anchor high load design.

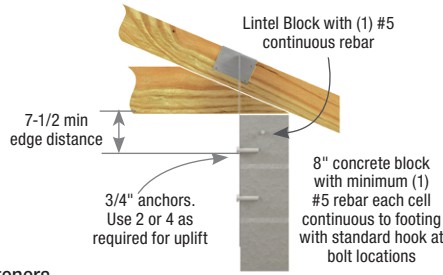
**Materials:** 10 gauge

**Finish:** Primer

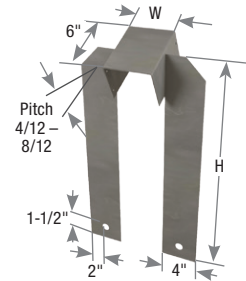
**Codes:** See page 12 for Code Reference Chart

**Installation:**

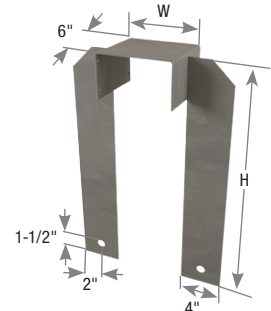
- Use all specified fasteners. See Product Notes, page 20.
- Place connector over truss or rafter and fasten with specified fasteners.
- Designer shall be responsible for design of masonry structure, including any required reinforcement.
- For 2-ply applications, add filler block. Refer to page 257 for wood filler block installation.
- Works with heel heights up to 14".
- **Moisture barrier may be required.**



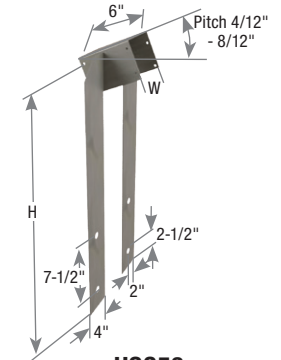
**Typical USC53 installation**  
UGTS Similar



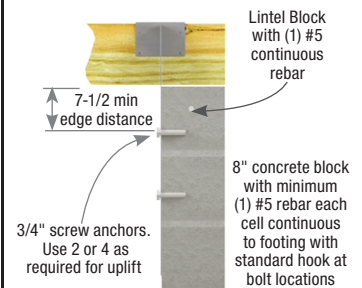
**UGTS63**



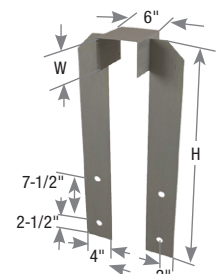
**UGTS4F**



**USC53**



**Typical USC3F installation**  
UGTS similar



**USC3F**

Description	MiTek USP Stock No.	Ref. No.	Steel Gauge	Dimensions (in)		Fastener Schedule				DF/SP Allowable Loads (Lbs.)	Code Ref.
				W	H	Rafter/ Truss		Concrete/ Masonry Wall			
						Qty	Type <sup>5</sup>	Qty	Screw Anchor <sup>2,3,4</sup>		
3-Ply Flat	UGTS3F	--	10	4-3/4	23	8	16d	2	3/4" x 6"	7813	
	USC3F	--	10	4-3/4	30-1/2	8	16d	2 4	3/4" x 6"	7813 10133	
4-Ply Flat	UGTS4F	--	10	6-1/2	23	8	16d	2	3/4" x 6"	7813	
	USC4F	--	10	6-1/2	30-1/2	8	16d	2 4	3/4" x 6"	7813 10133	
4/12 pitch	UGTS43	--	10	4-3/4	23	8	16d	2	3/4" x 6"	7813	
	UGTS44	--	10	6-1/2	23	8	16d	2	3/4" x 6"	7813	
	USC43	--	10	4-3/4	30-1/2	8	16d	2 4	3/4" x 6"	7813 10133	
	USC44	--	10	6-1/2	30-1/2	8	16d	2 4	3/4" x 6"	7813 10133	
5/12 pitch	UGTS53	--	10	4-3/4	23	8	16d	2	3/4" x 6"	7813	
	UGTS54	--	10	6-1/2	23	8	16d	2	3/4" x 6"	7813	
	USC53	--	10	4-3/4	30-1/2	8	16d	2 4	3/4" x 6"	7813 10133	
	USC54	--	10	6-1/2	30-1/2	8	16d	2 4	3/4" x 6"	7813 10133	
6/12 pitch	UGTS63	--	10	4-3/4	23	8	16d	2	3/4" x 6"	7813	
	UGTS64	--	10	6-1/2	23	8	16d	2	3/4" x 6"	7813	
	USC63	--	10	4-3/4	30-1/2	8	16d	2 4	3/4" x 6"	7813 10133	
	USC64	--	10	6-1/2	30-1/2	8	16d	2 4	3/4" x 6"	7813 10133	
7/12 pitch	UGTS73	--	10	4-3/4	23	8	16d	2	3/4" x 6"	7813	
	UGTS74	--	10	6-1/2	23	8	16d	2	3/4" x 6"	7813	
	USC73	--	10	4-3/4	30-1/2	8	16d	2 4	3/4" x 6"	7813 10133	
	USC74	--	10	6-1/2	30-1/2	8	16d	2 4	3/4" x 6"	7813 10133	
8/12 pitch	UGTS83	--	10	4-3/4	23	8	16d	2	3/4" x 6"	7813	
	UGTS84	--	10	6-1/2	23	8	16d	2	3/4" x 6"	7813	
	USC83	--	10	4-3/4	30-1/2	8	16d	2 4	3/4" x 6"	7813 10133	
	USC84	--	10	6-1/2	30-1/2	8	16d	2 4	3/4" x 6"	7813 10133	

1) Uplift loads have been increased 60% for wind or seismic loads; no further increase shall be permitted.  
 2) Use DeWalt 3/4" dia. x 6" Screw-Bolt™+; or equal, installed in accordance with manufacturer's specifications.  
 3) DeWalt 3/4" dia. x 6" Screw-Bolt™+ are not supplied with ties. See page 34 for anchor information.  
 4) Fasteners shall be installed to fully grouted and reinforced concrete masonry or reinforced concrete (f'c = 2,500 psi at 28 days).  
 5) **NAILS:** 16d nails are 0.162" dia. x 3-1/2" long.

# LUGT Girder Tiedowns



The LUGT series is an extremely adaptable tiedown for girder trusses and offers several installation options to accommodate different framing conditions. It is an ideal retrofit solution to reinforce truss connections to transfer high wind loads to supporting walls and can be used on either concrete or CMU block walls. Sizes available for 2-ply, 3-ply and 4-ply trusses.

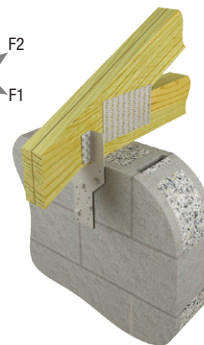
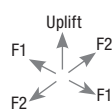
**Materials:** See chart

**Finish:** G90 galvanizing

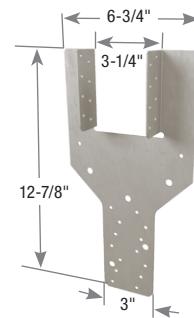
**Codes:** See page 12 for Code Reference Chart

**Installation:**

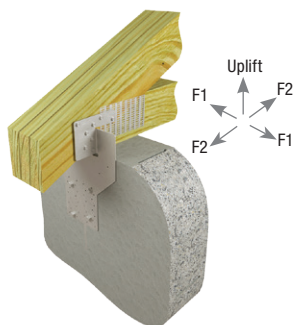
- Use all specified fasteners. See Product Notes, page 20.
- All fastener holes must be filled with specified fasteners to achieve loads listed in the chart. Smaller fastener holes are for girder-to-stud applications (reference page 232) and do not need to be filled when used for concrete/masonry installations.
- WS Wood Screws included with LUGT3 and LUGT4.
- **For concrete and masonry applications, a moisture barrier may be required, check local building code.**



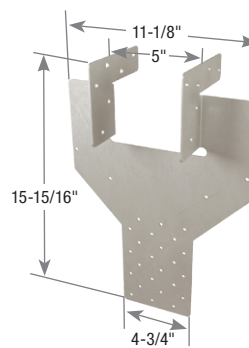
**Typical LUGT2 masonry installation**



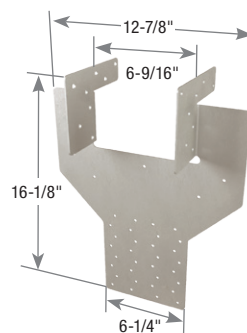
**LUGT2**



**Typical LUGT4 masonry installation (LUGT3 similar)**



**LUGT3**



**LUGT4**

MiTek USP Stock No.	Ref. No.	Steel Gauge	No. of Plies	Fastener Schedule <sup>2</sup>				DF/SP Allowable Loads (Lbs.) <sup>1</sup>			S-P-F Allowable Loads (Lbs.) <sup>1</sup>			Code Ref.
				Rafter/Truss		CMU/Concrete Wall <sup>4</sup>		Uplift 160%	F1 160%	F2 160%	Uplift 160%	F1 160%	F2 160%	
				Qty	Type <sup>5,6</sup>	Qty	Screw Anchor <sup>3</sup>							
<b>Concrete/Masonry Installation</b>														
LUGT2	LGT2	14	2	16	10d	5	1/4" x 3"	1550	1505	475	1550	1265	400	--
LUGT3	LGT3-SDS2.5	12	3	12	WS25	4	3/8" x 5"	3525	--	--	3240	--	--	
LUGT4	LGT4-SDS3	12	4	16	WS3	4	3/8" x 5"	3525	--	--	3525	--	--	

1) Allowable loads have been increased 60% for wind or seismic loads; no further increase shall be permitted.  
 2) Additional anchorage products to be designed by others.  
 3) Use DeWalt Screw-Bolt™+ 1/4" dia. x 3" or 3/8" dia. x 5" screw anchors; or equal, installed in accordance with manufacturer's specification. Screw Anchors must be ordered separately, see page 44 for anchor information.  
 4) Fasteners must be installed in fully grouted and reinforced concrete masonry (f'm = 1,500 psi) or reinforced concrete (f'c = 2,500 psi).  
 5) WS25 Wood Screws are 1/4" dia. x 2-1/2" long (supplied with LUGT3) and WS3 Wood Screws are 1/4" dia. x 3" long (supplied with LUGT4).  
 6) **NAILS:** 10d nails are 0.148" dia. x 3" long.

Designed for higher uplift resistance for concrete block construction. The MUGT15 can accommodate variable truss bearing depths.

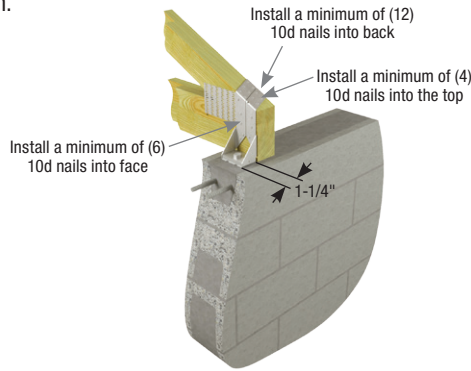
**Materials:** 12 gauge

**Finish:** G90 galvanizing

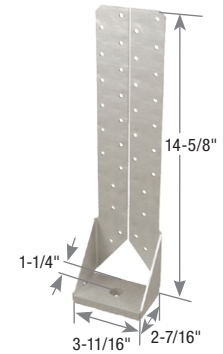
**Codes:** See page 12 for Code Reference Chart

**Installation:**

- Use all specified fasteners. See Product Notes, page 20.
- When straps are wrapped over the truss, install nails in backside of truss. See MUGT15 installation diagram for minimum nail requirements into the face and on top of the truss.
- If installed straight-up with no wrap over the top of the truss, fill all nail holes.
- **Moisture barrier may be required.**



**Typical MUGT15 installation**



**MUGT15**

MiTek USP Stock No.	Ref. No.	Steel Gauge	Mounting Condition	Fastener Schedule <sup>3</sup>						DF/SP Allowable Loads (Lbs.)	Code Ref.
				Anchor Bolt <sup>2,4</sup>		Rafter/Truss <sup>5</sup>					
				Qty	Dia (in)	Top Qty	Face Qty	Back Qty	Type	Uplift 160% <sup>1</sup>	
<b>Concrete/Masonry Installation</b>											
MUGT15	MGT	12	Face-Max	1	5/8	--	28	--	10d	4495	IBC, FL, LA
			Top-Min	1	5/8	4	6	12	10d	4175	

- 1) Allowable loads have been increased 60% for wind or seismic loads; no further increase shall be permitted.
  - 2) **MiTek-USP CIA-GEL 7000-C may be used to anchor 5/8" threaded rod when installed into an 8" wide reinforced masonry or concrete wall. With 12" minimum embedment, the MUGT15 will achieve loads listed in table. Reinforcement is to be specified by the certified designer.**
  - 3) Additional anchorage products to be designed by others.
  - 4) Designer must specify anchor bolt type, length, and embedment.
  - 5) **NAILS:** 10d nails are 0.148" dia. x 3" long.
- New products or updated product information are designated in **blue font**.

## HUGT Girder Tiedowns

The HUGT series high uplift girder tiedowns can be installed on beams and top chords of trusses with slopes from 0° to 34°.

**Materials:** 7 gauge

**Finish:** Primer

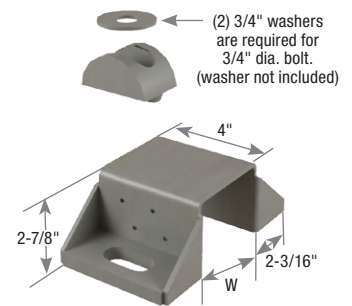
**Codes:** See page 12 for Code Reference Chart

**Installation:**

- Use all specified fasteners. See Product Notes, page 20.
- Install the HUGT over the beam or truss (see "W" dimension on chart for appropriate width).
- Attached members shall be designed to resist applied loads.
- **Moisture barrier may be required.**



**Typical HUGT2 installation**



**HUGT**

MiTek USP Stock No.	Ref. No.	Steel Gauge	W (in)	O.C. Dim Between Anchors (in)	Fastener Schedule <sup>3,4,5</sup>				DF/SP Allowable Loads (Lbs.) <sup>1,2</sup>	S-P-F Allowable Loads (Lbs.) <sup>1,2</sup>	Code Ref.
					Threaded Rod		Girder				
					Qty	Dia (in)	Qty	Type	Uplift 160%	Uplift 160%	
<b>Concrete/Masonry Installation</b>											
HUGT2	HGT-2	7	3-5/16	5-3/4	2	3/4	8	10d	<b>9575</b>	<b>6925</b>	FL
HUGT3	HGT-3	7	4-15/16	7-3/8	2	3/4	8	10d	9860	<b>7805</b>	
HUGT4	HGT-4	7	6-7/8	9	2	3/4	8	10d	9860	<b>7790</b>	

- 1) Allowable loads have been increased 60% for wind or seismic loads; no further increase shall be permitted.
  - 2) Listed loads apply where roof pitch is between 3:12 and 8:12.
  - 3) Additional anchorage products to be designed by others.
  - 4) Designer must specify anchor bolt type, length, and embedment.
  - 5) **NAILS:** 10d nails are 0.148" dia. x 3" long.
- New products or updated product information are designated in **blue font**.

# HGAM Hurricane Gusset Angles



Designed for attaching gable end trusses to wood top plates and masonry walls.

For installation into grouted concrete tie beam or masonry bond beam. Provides lateral and uplift resistance.

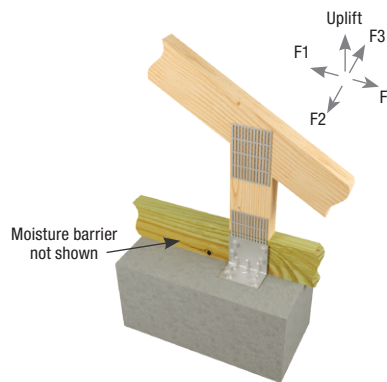
**Materials:** 14 gauge

**Finish:** G90 galvanizing

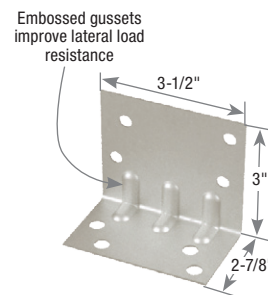
**Codes:** See page 12 for Code Reference Chart

**Installation:**

- Use all specified fasteners. See Product Notes, page 20.
- Install USP's WS15 Wood Screws into the truss and drill holes for screw anchors. Install screw anchors into concrete block per manufacturer's recommendation.
- WS Wood Screws and screw anchors are included with HGAM10 angles.
- **Moisture barrier may be required.**



Typical HGAM10 installation



HGAM10

MiTek USP Stock No.	Ref. No.	Steel Gauge	Fastener Schedule				DF/SP Allowable Loads (Lbs.) <sup>1</sup>				Code Ref.
			Rafter/Truss		Plate		Uplift 160%	F1 160%	F2 160%	F3 160%	
			Qty	Type <sup>2</sup>	Qty	Screw Anchor <sup>3</sup>					
HGAM10KT	HGAM10KTA	14	4	WS15	4	1/4" x 1-3/4"	915	1075	1110	740	FL

1) Allowable loads have been increased 60% for wind or seismic loads; no further increase shall be permitted.  
 2) WS15 Wood Screws, 1/4" dia. x 1-1/2" long, are supplied with HGAM10KT.  
 3) Use DeWalt 1/4" x 1-3/4" Screwbolt™+ (included); or equal, installed in accordance with manufacturer's specification.

## SHA Masonry Uplift Connectors

Connects trusses directly to masonry or concrete and features slotted base holes to ease installation.

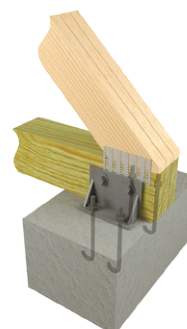
**Materials:** Angle – 3 gauge; Gussets – 10 gauge

**Finish:** Primer

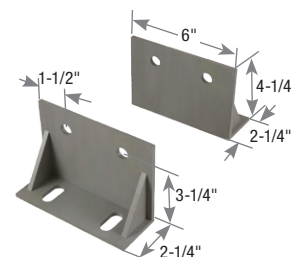
**Codes:** See page 12 for Code Reference Chart

**Installation:**

- Use all specified fasteners. See Product Notes, page 20.
- Install directly flush to masonry wall.
- **The SHA series connectors shall be installed in pairs.**
- **Moisture barrier may be required.**



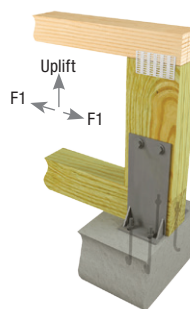
Typical SHA6 installation



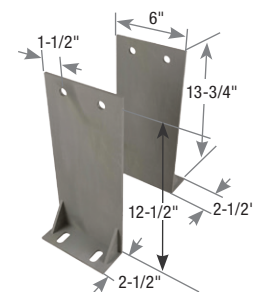
SHA6

MiTek USP Stock No.	Ref. No.	Fastener Schedule <sup>3</sup>				No. of Plies <sup>6</sup>	DF/SP Allowable Loads (Lbs.) <sup>1,2</sup>		Code Ref.
		Concrete Wall		Rafter/Truss <sup>7</sup>			Uplift 160%	F1 160%	
		Qty	Dia (in)	Qty	Bolt Dia (in)				
SHA6	--	4	1/2	2	3/4	2-Ply	3745	4005	--
						3-Ply or greater	5615	5565	
SHA6T	--	4	1/2	2	3/4	2-Ply	8370	1590	--
						3-Ply or greater		2190	

1) Allowable loads have been increased 60% for wind or seismic loads; no further increase shall be permitted.  
 2) Allowable loads are for a pair of SHA devices. SHA's shall be installed in pairs.  
 3) Fastener schedule is for a pair of SHA devices.  
 4) 1/2" x 8" J-Bolts or equivalent.  
 5) Concrete compressive strength shall be 2,500 psi or greater at 28 days.  
 6) Multiple ply truss shall be fastened together to act as a single unit.  
 7) Bolts shall conform to ASTM A 307 or better.  
 8) The designer must specify anchor bolt type, length, and embedment.



Typical SHA6T installation



SHA6T

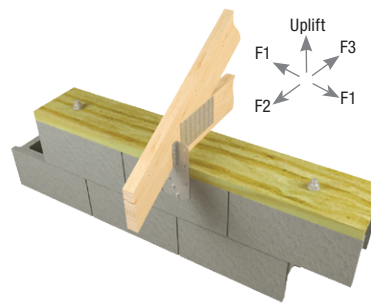
Copyright © 2019 MiTek Industries, Inc. All Rights Reserved

# RTM Hurricane Retrofit Connector

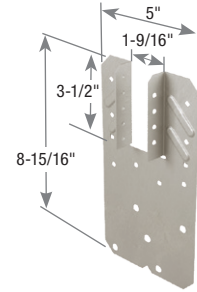
Designed as a retrofit connector for trusses installed on top plates. Can also be used as a holdown for a roof or floor system.

- Materials:** 18 gauge  
**Finish:** G90 galvanizing  
**Codes:** See page 12 for Code Reference Chart

- Installation:**
- Use all specified fasteners. See Product Notes, page 20.
  - Tapcon® Concrete Screws are not supplied with RT16M connector.
  - Install Tapcon® Concrete Screws in lower two holes for Single Top Plate or Conventional Raised Foundation or Modular Home Installations.
  - **Moisture barrier may be required.**



**Typical RT16M top plate installation**



**RT16M**

MiTek USP Stock No.	Ref. No.	Steel Gauge	Fastener Schedule						DF/SP Allowable Loads (Lbs.) <sup>1</sup>				S-P-F Allowable Loads (Lbs.) <sup>1</sup>				Code Ref.
			Truss/Rafter <sup>5</sup>		Top Plate <sup>5</sup>		CMU/Concrete <sup>2,3,4</sup>		Uplift 160%	F1 160%	F2 160%	F3 160%	Uplift 160%	F1 160%	F2 160%	F3 160%	
			Qty	Type	Qty	Type	Qty	Screws (in)									
RT16M	HM9KT	18	9	10d x 1-1/2"	--	--	4	1/4 x 1-3/4"	1395	630	115	480	1395	630	115	480	FL
					4	16d	2	Tapcon	1360	--	--	--	1360	--	--	--	

- 1) Allowable loads have been increased 60% for wind or seismic loads; no further increase shall be permitted.
- 2) Install with 1/4" x 1-3/4" Tapcon® Concrete Screws in accordance to manufacturer's installation specifications.
- 3) Fasteners to be installed to fully grouted and reinforced concrete masonry.
- 4) Concrete compressive strength shall be 2,500 psi or greater at 28 days.
- 5) **NAILS:** 10d x 1-1/2" nails are 0.148" dia. x 1-1/2" long, 16d nails are 0.162" dia. x 3-1/2" long.

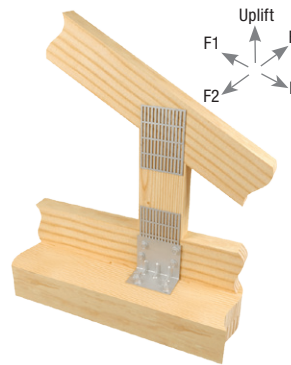
# HGA Hurricane Gusset Angles

Designed for attaching gable end trusses to wood top plates and masonry walls.

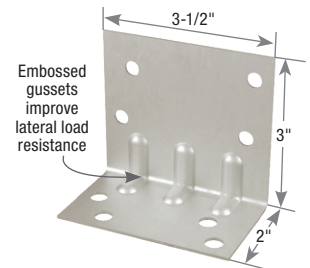
Versatile wood-to-wood connector that satisfies high wind and seismic loading requirements.

- Materials:** 14 gauge  
**Finish:** G90 galvanizing  
**Codes:** See page 12 for Code Reference Chart

- Installation:**
- Use all specified fasteners. See Product Notes, page 20.
  - Install with WS3 Wood Screws into top plate and WS15 Wood Screws into the truss.
  - USP's WS Wood Screws are included with HGA10 angles.
  - **Moisture barrier may be required.**



**Typical HGA10 installation**



**HGA10**

MiTek USP Stock No.	Ref. No.	Steel Gauge	Fastener Schedule <sup>2</sup>				Wall Framing	DF/SP Allowable Loads (Lbs.) <sup>1</sup>				Code Ref.
			Rafter/Truss		Plate			Uplift 160%	F1 160%	F2 160%	F3 160%	
			Qty	Type	Qty	Type						
HGA10KT	HGA10KT	14	4	WS15	4	WS3	2x4	790	1100	340	840	IBC, FL, LA
							2x6			1065		

- 1) Allowable loads have been increased 60% for wind or seismic loads; no further increase shall be permitted.
- 2) WS15 Wood Screws are 1/4" dia. x 1-1/2" long and WS3 Wood Screws are 1/4" dia. x 3" long.

# LUGT Girder Tiedowns



The LUGT series is an extremely adaptable tiedown for girder trusses and offers several installation options to accommodate different framing conditions. It is an ideal retrofit solution to reinforce truss connections to transfer high wind loads to supporting walls. Sizes available for 1-ply, 2-ply, 3-ply and 4-ply trusses.

**Materials:** See chart

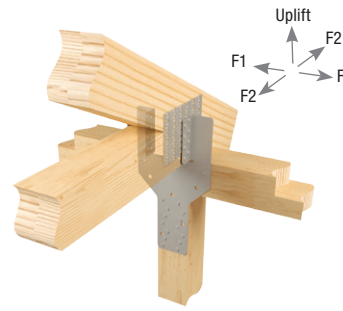
**Finish:** G90 galvanizing

**Codes:** See page 12 for Code Reference Chart

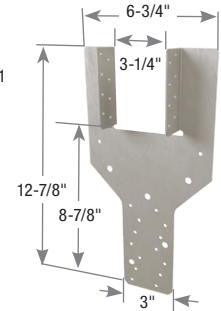
**Installation:**

- Use all specified fasteners. See Product Notes, page 20.
- All fastener holes must be filled with specified fasteners to achieve loads listed in the chart. Large fastener holes are for concrete/masonry installations (reference page 228) and do not need to be filled when used for girder-to-stud applications.
- WS Wood Screws included with LUGT3 and LUGT4.

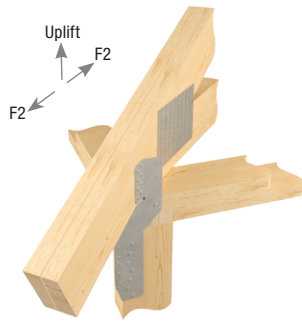
Truss & Rafter



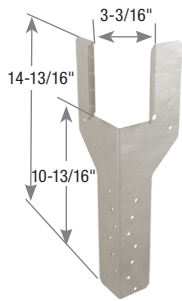
**Typical LUGT2 installation**



**LUGT2**



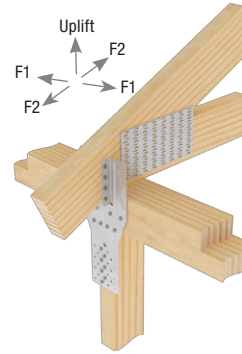
**Typical LUGTC2 corner hip installation**



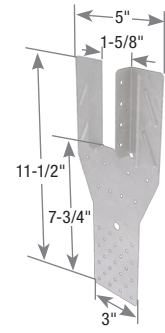
**LUGTC2**



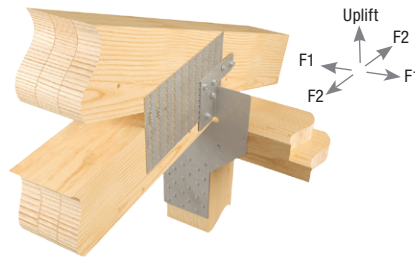
**Typical LUGT1 offset stud installation**  
(See footnote #4)



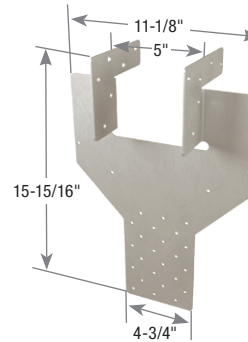
**Typical LUGT1 installation**



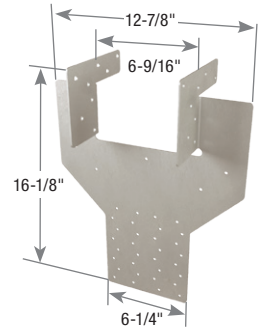
**LUGT1**



**Typical LUGT3 installation**  
(LUGT4 similar)



**LUGT3**



**LUGT4**

No. of Plies	MiTek USP Stock No.	Ref. No.	Steel Gauge	Fastener Schedule <sup>2,3,7</sup>						DF/SP			S-P-F			Code Ref.
				Rafter/Truss		Plate		Stud		Allowable Loads (Lbs.) <sup>1</sup>			Allowable Loads (Lbs.) <sup>1</sup>			
				Qty	Type	Qty	Type	Qty	Type	Uplift <sup>4</sup> 160%	F1 160%	F2 160%	Uplift <sup>4</sup> 160%	F1 160%	F2 160%	
<b>Wood-to-Wood Installation</b>																
1	LUGT1	H10S	18	8	8d x 1-1/2	8	8d x 1-1/2	7	8d x 1-1/2	1045	675	175	875	565	175	--
2	LUGT2	LGT2	14	16	10d	2	10d	14	10d	2260	1015	505	1900	850	425	IBC, FL, LA
	LUGTC2	--	14	16	10d	2	10d	14	10d	2260	--	575	1900	--	480	
3	LUGT3	LGT3-SDS2.5	12	12	WS25	4	16d Sinker	24	16d Sinker	3855	1980	890	3240	1660	745	--
4	LUGT4	LGT4-SDS3	12	16	WS3	5	16d Sinker	32	16d Sinker	4640	--	--	3900	--	--	--

1) Allowable loads have been increased 60% for wind or seismic loads; no further increase shall be permitted.  
 2) Additional anchorage products to be designed by others.  
 3) For proper installation, the number of studs must be equal-to or greater-than the number of roof truss plies.  
 4) The LUGT1 can be installed with the stud offset from the rafter a maximum of 1" (center-to-center) for a reduced allowable uplift load of 1,000-lb (DF/SP) and 840-lb (S-P-F).  
 5) Fasteners must be installed in fully grouted and reinforced concrete masonry (f'm = 1,500 psi) or reinforced concrete (f'c = 2,500 psi).  
 6) Use DeWalt Screw-Bolt™ + 1/4" dia. x 3" or 3/8" dia. x 5" screw anchors; or equal, installed in accordance with manufacturer's specification.  
 7) **NAILS:** 8d x 1-1/2 are 0.131" dia. x 1-1/2" long, 10d nails are 0.148" dia. x 3" long, 16d Sinks are 0.148" dia. x 3-1/4" long, WS25 Wood Screws are 1/4" dia. x 2-1/2" long (supplied with LUGT3) and WS3 Wood Screws are 1/4" dia. x 3" long (supplied with LUGT4).



Designed for higher uplift resistance for wood frame construction. The MUGT15 can accommodate variable truss bearing depths.

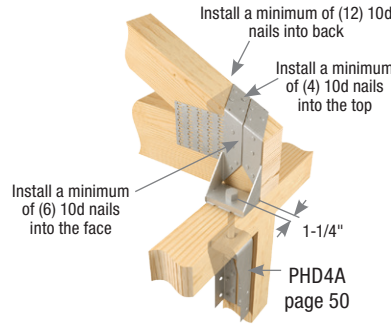
**Materials:** 12 gauge

**Finish:** G90 galvanizing

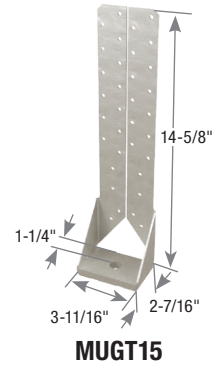
**Codes:** See page 12 for Code Reference Chart

**Installation:**

- Use all specified fasteners. See Product Notes, page 20.
- When straps are wrapped over the truss, install nails in backside of truss. See MUGT15 installation diagram for minimum nail requirements into the face and on top of the truss.
- If installed straight-up with no wrap over the top of the truss, fill all nail holes.
- **Moisture barrier may be required.**



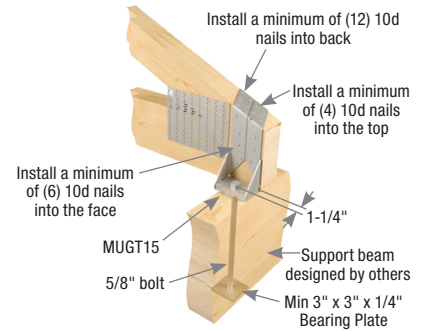
**Typical MUGT15 top-min installation with PHD4A**



**MUGT15**

MiTek USP Stock No.	Ref. No.	Steel Gauge	Mounting Condition	Fastener Schedule <sup>2</sup>						DF/SP Allowable Loads (Lbs.) <sup>1</sup>	Code Ref.
				Rod/Bolt <sup>3</sup>		Rafter/Truss <sup>4</sup>					
				Qty	Dia (in)	Top Qty	Face Qty	Back Qty	Type		
Wood-To-Wood Installation											
MUGT15	MGT	12	Face-Max	1	5/8	--	28	--	10d	4495	IBC, FL, LA
			Top-Min	1	5/8	4	6	12	10d	4175	

- 1) Allowable loads have been increased 60% for wind or seismic loads; no further increase shall be permitted.
- 2) Additional anchorage products to be designed by others.
- 3) Designer must specify anchor bolt type, length, and holdown device.
- 4) **NAILS:** 10d nails are 0.148" dia. x 3" long.



**Typical MUGT15 connection to support beam**

# HUGT Girder Tiedowns

The HUGT series high uplift girder tiedowns can be installed on beams and top chords of trusses with slopes from 0° to 34°.

**Materials:** 7 gauge

**Finish:** Primer

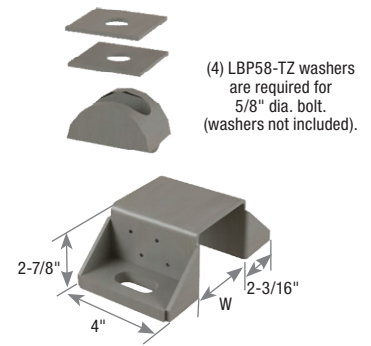
**Codes:** See page 12 for Code Reference Chart

**Installation:**

- Use all specified fasteners. See Product Notes, page 20.
- Install the HUGT over the beam or truss (see "W" dimension on chart for appropriate width).
- Install (4) LBP58-TZ washers for (2) 5/8" tension rod/bolts.
- Attached members shall be designed to resist applied loads.
- **Moisture barrier may be required.**



**Typical HUGT3 installation with HTT45's**



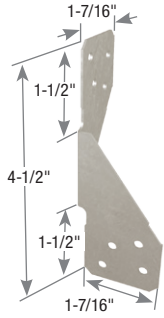
**HUGT**

MiTek USP Stock No.	Ref. No.	Steel Gauge	W (in)	O.C. Dim Between Anchors (in)	Fastener Schedule <sup>3,5</sup>						DF/SP Allowable Loads (Lbs.) <sup>1,2</sup>	S-P-F Allowable Loads (Lbs.) <sup>1,2</sup>	Code Ref.
					Anchor Washers		Threaded Rod	Girder					
					Qty	Type	Qty	Dia (in)	Qty	Type			
Wood-to-Wood Installation													
HUGT2	HGT-2	7	3-5/16	5-3/4	4	LBP58-TZ	2	5/8	8	10d	9575	6925	FL
HUGT3	HGT-3	7	4-15/16	7-3/8	4	LBP58-TZ	2	5/8	8	10d	9860	7805	
HUGT4	HGT-4	7	6-7/8	9	4	LBP58-TZ	2	5/8	8	10d	9860	7790	

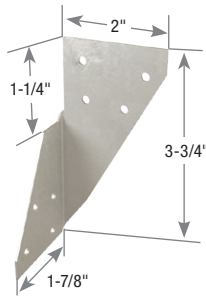
- 1) Allowable loads have been increased 60% for wind or seismic loads; no further increase shall be permitted.
  - 2) Listed loads apply where roof pitch is between 3:12 and 8:12.
  - 3) Additional anchorage products to be designed by others.
  - 4) Designer must specify anchor bolt type, length, and holdown device.
  - 5) **NAILS:** 10d nails are 0.148" dia. x 3" long.
- New products or updated product information are designated in **blue font**.

These anchors tie trusses and rafters to top plates and may be used to tie wood framing members to resist uplift and lateral forces.

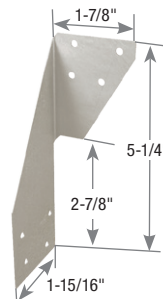
Truss & Rafter



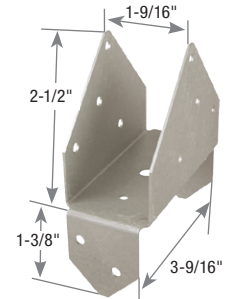
**RT3A**



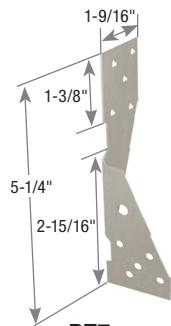
**RT4**  
(left version shown)



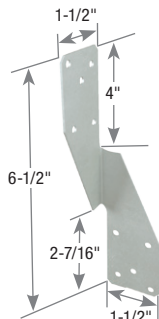
**RT5**  
(left version shown)



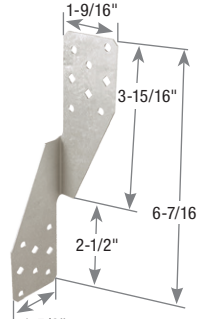
**RT6**



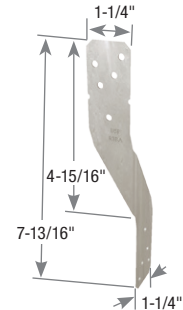
**RT7**  
(left version shown)



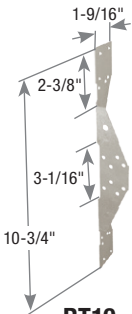
**RT7A**



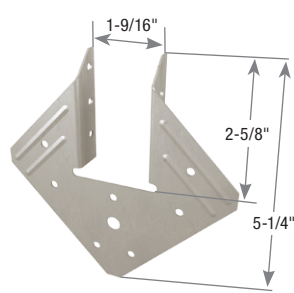
**RT7AT**



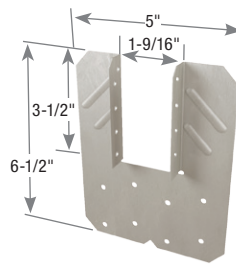
**RT8A**



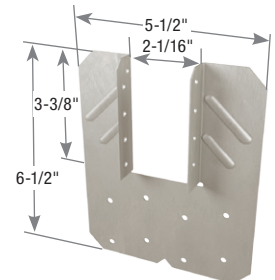
**RT10**



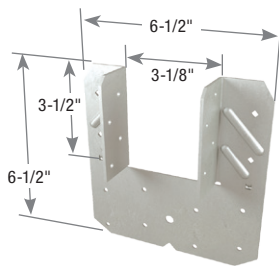
**RT15**



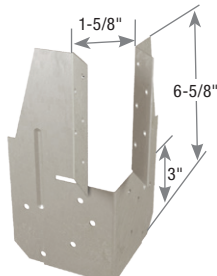
**RT16A**



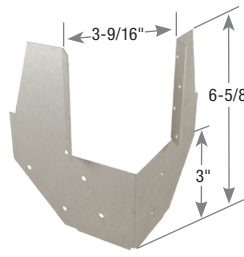
**RT16AR**



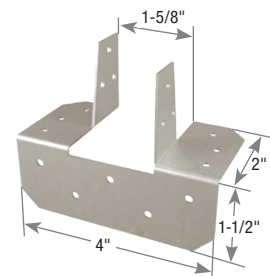
**RT16-2**



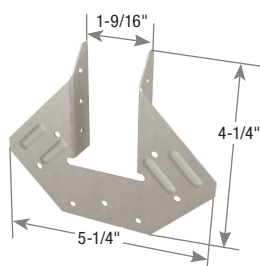
**HHCP2**



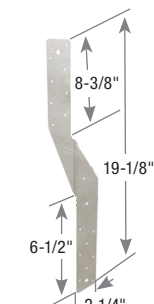
**HHCP4-TZ**



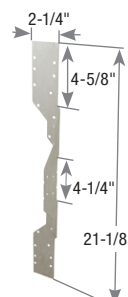
**HC520**



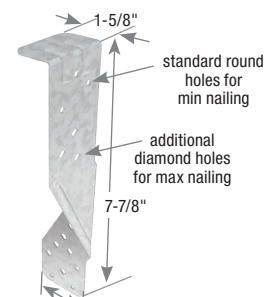
**HCPRS**



**LFTA6**  
(left version shown)



**RT20**



**TSP**

standard round holes for min nailing

additional diamond holes for max nailing

Copyright © 2019 MiTek Industries, Inc. All Rights Reserved

**Materials:** See chart

**Finish:** G90 galvanizing; HHCP4-TZ – G-185 galvanizing.

**Options:** See chart for Corrosion Finish Options

**Codes:** See page 12 for Code Reference Chart IRC 802.10.5. IBC 2308.10.1

**Installation:**

- Use all specified fasteners. See Product Notes, page 20.
- **TSP Min Nailing** – Fill all round holes.
- **TSP Max Nailing** – Fill all round and diamond holes.
- To achieve full allowable loads listed, fasteners must be installed as prescribed in the chart.
- Depending on pitch, birdsmouth notching may be required with some models to enable installers to fill all nail holes.
- Designer shall determine if solid blocking is required.
- LFTA6, RT4, RT5, and RT7 ship in equal quantities of left and right versions. Left version images shown.



MiTek USP Stock No.	Ref. No.	Steel Gauge	Fastener Schedule <sup>3,4</sup>						DF/SP Allowable Loads (Lbs.) <sup>1</sup>					S-P-F Allowable Loads (Lbs.) <sup>1</sup>					Corrosion Finish	Code Ref.
			Truss/Rafter		Plate		Stud		Uplift 160%	Lateral				Uplift 160%	Lateral					
			Qty	Type	Qty	Type	Qty	Type		F1 160%	F2 160%	F3 160%	F4 160%		F1 160%	F2 160%	F3 160%	F4 160%		
RT3A	H3	18	4	8d x 1-1/2	4	8d	--	--	345	190	65	130	90	305	155	65	130	90	Green	
			4	8d x 1-1/2	4	8d x 1-1/2	--	--	345	190	65	130	90	305	155	65	130	90		
RT4	--	18	4	8d x 1-1/2	4	8d	--	--	335	225	140	240	255	295	180	140	205	175	Green	
RT5	--	18	4	8d x 1-1/2	4	8d	--	--	380	160	80	280	180	335	160	80	225	180	Green	
RT6	HS24	18	8	8d x 1-1/2	6	8d	--	--	605	835	800	--	--	535	670	575	--	--	Green	
RT7	--	18	5	8d x 1-1/2	5	8d	--	--	560	270	120	185	140	495	270	120	185	140	Green	
			5	8d x 1-1/2	5	8d x 1-1/2	--	--	515	270	120	185	140	425	270	120	185	140		
RT7A	H2.5A	18	5	8d x 1-1/2	5	8d	--	--	585	290	190	135	120	515	235	190	110	120	Green	
			5	8d x 1-1/2	5	8d x 1-1/2	--	--	630	290	190	135	120	425	235	190	110	120		
RT7AT	H2.5T	18	5	8d x 1-1/2	5	8d x 1-1/2	--	--	515	265	150	240	165	455	215	150	240	165	Green	
RT8A	H8	18	5	10d x 1-1/2	5	10d x 1-1/2	--	--	760	265	100	225	150	670	265	100	225	150	Green	IBC, FL, LA
RT10	H2A	18	6	8d x 1-1/2	8	8d	6	8d	560	270	120	185	140	495	270	120	185	140	Green	
			6	8d x 1-1/2	6	8d x 1-1/2	6	8d x 1-1/2	515	270	120	185	140	460	270	120	185	140		
RT15	H1	18	5	8d x 1-1/2	5	8d	--	--	520	510	220	415	--	460	410	220	415	--	Green	
			5	8d x 1-1/2	5	8d x 1-1/2	--	--	580	510	220	415	--	425	410	220	415	--		
RT16A	H10A, H14	18	9	10d x 1-1/2	8	10d	--	--	1020	805	490	455	--	895	660	345	455	--	Green	
			9	8d x 1-1/2	8	8d x 1-1/2	--	--	935	805	490	455	--	815	660	345	455	--		
RT16AR	H10AR	18	9	10d x 1-1/2	8	10d	--	--	1020	805	490	455	--	895	660	345	455	--	Green	
RT16-2	--	18	8	8d	8	8d	--	--	1060	780	410	405	--	935	625	330	320	--	Green	
HHCP2	HCP2	18	10	10d x 1-1/2	10	10d x 1-1/2	--	--	680	405	--	--	--	570	340	--	--	--	Green	
HHCP4-TZ	HCP4Z	16	8	10d	8	10d	--	--	980	370	--	--	--	825	310	--	--	--	Green	
HC520	GBC	18	--	--	11	8d	6	8d	515	470	430	--	--	445	405	370	--	--	Green	
			--	--	11	8d x 1-1/2	6	8d x 1-1/2	515	470	430	--	--	445	405	370	--	--		
HCPRS	--	18	6	8d	5	8d	--	--	495	525	345	570	--	415	440	290	480	--	Green	
LFTA6 <sup>2</sup>	H6	16	8	8d	8	8d	--	--	980	745	120	--	--	825	625	100	--	--	Green	
			8	8d x 1-1/2	8	8d x 1-1/2	--	--	980	745	120	--	--	825	625	100	--	--		
RT20	H7	16	9	10d x 1-1/2	4	10d	9	10d x 1-1/2	1125	--	--	--	--	990	--	--	--	--	Green	IBC, FL, LA
TSP	TSP	16	3	10d x 1-1/2	3	10d x 1-1/2	--	--	465	--	--	--	--	390	--	--	--	--	Green	
			9	10d x 1-1/2	6	10d x 1-1/2	--	--	830	365	190	210	235	700	305	160	175	200		
			9	10d x 1-1/2	6	10d	--	--	870	365	190	210	235	730	305	160	175	200		

**Corrosion Finish**

- Stainless Steel
- Gold Coat
- HDG
- Triple Zinc

Copyright © 2019 MiTek Industries, Inc. All Rights Reserved

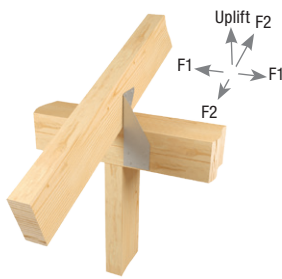
1) Allowable loads have been increased 60% for wind or seismic loads; no further increase shall be permitted.  
 2) LFTA6: To achieve F1 lateral loads, three nails must be installed on each side on the strap located closest to the bend line. Lateral F1 and F2 load directions do not apply to roof truss-to-top plate installations.  
 3) 8d common nails may be substituted for 8d x 1-1/2 nails, and 10d common nails may be substituted for 10d x 1-1/2 nails.  
 4) **NAILS:** 8d x 1-1/2 nails are 0.131" dia. x 1-1/2" long, 8d nails are 0.131" dia. x 2-1/2" long, 10d x 1-1/2 nails are 0.148" dia. x 1-1/2" long, 10d nails are 0.148" dia. x 3" long.



**Typical RT3A**  
truss/rafter to plate  
installation



**Typical RT4**  
truss/rafter to plate  
installation



**Typical RT5**  
truss/rafter to  
double plate installation



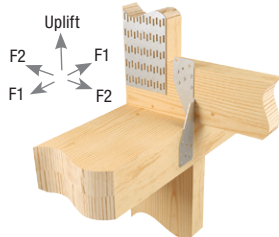
**Typical RT6**  
truss/rafter to  
plate installation



**Typical RT7**  
truss/rafter to  
double plate installation



**Typical RT7A**  
truss/rafter to  
double plate installation



**Typical RT7AT**  
2x4 bottom chord  
installation



**Typical RT8A**  
stud to double plate  
installation



**Typical RT10**  
truss/rafter to double plate  
to stud installation



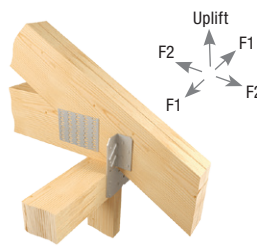
**Typical RT15**  
truss/rafter to  
double plate installation



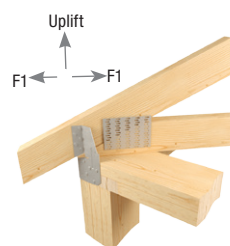
**Typical RT16A**  
truss/rafter to  
double plate installation



**Typical RT16AR**  
truss/rafter to  
double plate installation



**Typical RT16-2**  
truss/rafter to  
double plate installation



**Typical HHCP2**  
truss/rafter to double  
plate corner installation



**Typical HHCP4-TZ**  
truss/rafter to double  
plate corner installation



**Typical HC520**  
stud to plate  
installation



**Typical HC520**  
gable brace  
installation



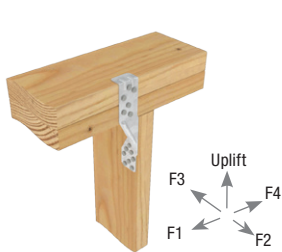
**Typical HCPRS**  
truss/rafter to plate  
installation



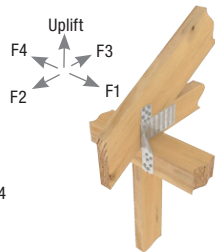
**Typical LFTA6**  
stud to plate  
installation



**Typical RT20**  
truss/rafter to double  
plate to stud installation



**Typical TSP top  
plate installation**  
(max nailing)



**Typical TSP**  
truss/rafter installation  
(max nailing)

**Anchor installation to achieve twice the load** (using two identical anchors)

Wall Top Plate

Install diagonally across from each other for minimum 1-1/2" truss/rafter.

Nailing into both sides of a single-ply 2x truss/rafter may cause damages in wood

# RUSC Retrofit Strap Connector

The RUSC Retro Uplift Strap Connector provides a wood-to-wood uplift connection attaching trusses with a 2x4 bottom chord to a double stud in the wall below. WS3 Wood Screws are utilized for fast installation. The connector can be installed after roof sheathing has been installed.

**Materials:** 10 gauge

**Finish:** Primer

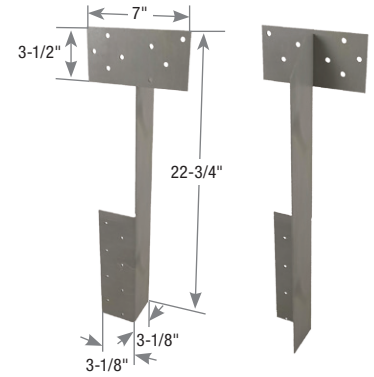
**Codes:** See page 12 for Code Reference Chart

**Installation:**

- Use all specified fasteners. See Product Notes, page 20.
- **The RUSC shall be installed in pairs.**
- Install on minimum 2-ply with equal wall studs centered directly below.
- Works with 2x4 bottom chord member and 2x4 wall studs.



Typical RUSC installation



RUSC

MiTek USP Stock No.	Ref. No.	Steel Gauge	No. of Plies <sup>6</sup>	Fastener Schedule <sup>4,5</sup>				DF/SP Allowable Loads (Lbs.) <sup>1</sup>		S-P-F Allowable Loads (Lbs.) <sup>1</sup>		Code Ref.
				Qty	Rafter/Truss	Qty	Stud	Uplift 160%		Uplift 160%		
RUSC	--	10	2-Ply or greater	16	WS3	16	WS3	6040		5225	FL	

- 1) Allowable loads are for a pair of RUSC devices.
- 2) Uplift loads have been increased 60% for wind or seismic loads; no further increase shall be permitted.
- 3) Designer must specify stud or post to resist published load values.
- 4) WS3 Wood Screws are 1/4" dia. x 3" long and are included with RUSC connectors.
- 5) Fastener schedule is for two straps used together. The RUSC shall be installed in pairs with a minimum 2-ply truss and wall stud attachment.
- 6) Truss plies shall be fastened together to act as a single unit.

# MUS / HUS Slant Nail Truss Hangers



The MUS / HUS hanger series offers double shear nailing. MiTek's raised dimple allows for 30° to 45° nailing through the joist into header, resulting in higher loads and less nailing.

**Materials:** MUS – 18 gauge; HUS – 16 gauge

**Finish:** G90 galvanizing

**Options:** See chart for Corrosion Finish Options

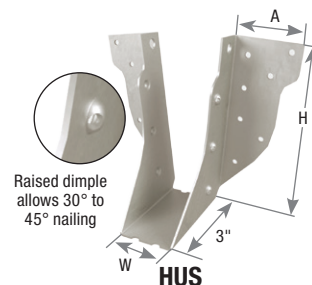
**Codes:** See page 12 for Code Reference Chart

**Installation:**

- Use all specified fasteners. See Product Notes, page 20.
- Joist nails must be driven in at a 30° to 45° angle through the joist or truss into the header to achieve listed loads. **Slant/double shear nails must be used to achieve listed load values.**
- See HUS EWP applications on page 192.

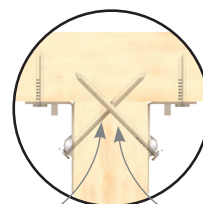


Typical HUS installation (MUS similar)



Raised dimple allows 30° to 45° nailing

HUS



Double shear nail design features fewer nails and faster installation

Uses standard length common nails



MUS

Joist / Truss Size	MiTek USP Stock No.	Ref. No.	Steel Gauge	Dimensions (in)			Fastener Schedule <sup>4</sup>				DF/SP Allowable Loads (Lbs.) <sup>3</sup>				S-P-F Allowable Loads (Lbs.) <sup>3</sup>				Corrosion Finish	Code Ref.
				W	H	A	Header		Truss <sup>2</sup>		Floor	Roof	Uplift <sup>1</sup>	Floor	Roof	Uplift <sup>1</sup>				
							Qty	Type	Qty	Type							100%	115%		
2 x 6 - 8	MUS26	MUS26	18	1-9/16	5-1/16	1	6	10d	6	10d	1285	1475	1605	865	1190	1365	1475	760		IBC, FL, LA
	HUS26	HUS26	16	1-5/8	5-7/16	2	14	16d	6	16d	2760	3140	3400	2035	2430	2765	2990	1630		
2 x 8 - 10	MUS28	MUS28	18	1-9/16	7-1/16	1	8	10d	8	10d	1710	1970	2140	1230	1585	1815	1965	1085		
	HUS28	HUS28	16	1-5/8	7-3/16	2	22	16d	8	16d	4170	4745	5090	2950	3670	4035	4105	2380		
2 x 10 - 12	HUS210	HUS210	16	1-5/8	9-3/16	2	30	16d	10	16d	5455	5825	6040	4110	4235	4565	4780	3390		
1-3/4 x 5-1/2 - 7-1/4	HUS175	HU1.81/5	16	1-13/16	5-3/8	2	14	16d	6	16d	2760	3140	3400	2035	2430	2765	2990	1630		
1-3/4 x 7-1/4 - 11-1/4	HUS177	--	16	1-13/16	7-1/8	2	22	16d	8	16d	4170	4745	5090	2950	3670	4105	4105	2380		
1-3/4 x 9-1/4 - 14	HUS179	HUS1.81/10	16	1-13/16	9-1/8	2	30	16d	10	16d	5580	6040	6040	4110	4555	4880	4895	3390		

- 1) Uplift loads have been increased 60% for wind or seismic loads; no further increase shall be permitted.
- 2) Nails must be driven at a 30° to 45° angle through joist or truss into header to achieve the table loads.
- 3) HUS175, HUS177, and HUS179 load values assume the joist is 1-3/4" wide and has a bearing strength of not less than 675 psi.
- 4) **NAILS:** 10d nails are 0.148" dia. x 3" long, 16d nails are 0.162" dia. x 3-1/2" long.

**Corrosion Finish**

- Stainless Steel
- Gold Coat
- HDG
- Triple Zinc

## CLPBF Butterfly Hanger

The butterfly hanger's flared header flange design allows for added nailing. Excellent truss-to-truss hanger for 2x4 purlin or truss bottom chords.

**Materials:** 18 gauge

**Finish:** G90 galvanizing

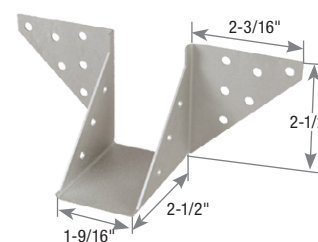
**Codes:** See page 12 for Code Reference Chart

**Installation:**

- Use all specified fasteners. See Product Notes, page 20.



Typical CLPBF installation



CLPBF

Joist Size	MiTek USP Stock No.	Ref. No.	Steel Gauge	Fastener Schedule <sup>2</sup>				DF/SP Allowable Loads (Lbs.)				Code Ref.
				Header		Joist		Floor	Roof	Uplift <sup>1</sup>		
				Qty	Type	Qty	Type				100%	
2 x 4	CLPBF	--	18	12	10d	6	10d x 1-1/2	1340	1340	1340	185	IBC, FL, LA

- 1) Uplift loads have been increased 60% for wind or seismic loads; no further increase shall be permitted.
- 2) **NAILS:** 10d x 1-1/2 nails are 0.148" dia. x 1-1/2" long, 10d nails are 0.148" dia. x 3" long.

Medium-to-heavy capacity face mount hanger.  
Some THD models are available with a min/max installation option.

**Materials:** See chart

**Finish:** G90 galvanizing

**Options:** See chart for Corrosion Finish Options

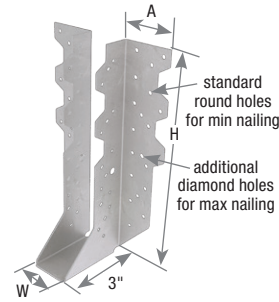
**Codes:** See page 12 for Code Reference Chart

**Installation:**

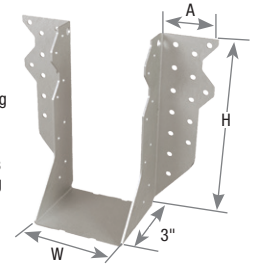
- Use all specified fasteners. See Product Notes, page 20.
- **Min Nailing** – Fill all round nail holes.
- **Max Nailing** – Fill all round and diamond holes.



Typical THD28 installation



THD210



THD double or larger

Some model designs may vary from illustration shown

Joist / Truss Size	MiTek USP Stock No.	Ref. No.	Steel Gauge	Dimensions (in)				Fastener Schedule <sup>2</sup>				DF/SP Allowable Loads (Lbs.)				Corrosion Finish	Code Ref.		
				W	H	D	A	Min/Max	Header		Truss		Floor		Roof			Uplift <sup>1</sup>	
									Qty	Type	Qty	Type	100%	115%	125%				160%
2 x 6 - 8	THD26	HTU26	16	1-5/8	5-1/16	3	1-7/8	Min	18	16d	12	10d x 1-1/2	2645	3000	3240	2265			
								Max	20	16d	20	10d x 1-1/2	2940	3260	3260	2315			
2 x 8 - 10	THD28	HTU28	16	1-5/8	7	3	1-7/8	Min	28	16d	16	10d x 1-1/2	4115	4195	4195	2315			
								Max	28	16d	26	10d x 1-1/2	4115	4670	5040	2315			
2 x 10 - 12	THD210	HTU210	16	1-5/8	9	3	1-7/8	Min	38	16d	20	10d x 1-1/2	5315	5590	5590	3775			
								Max	38	16d	32	10d x 1-1/2	5585	5990	5990	4010			
(2) 2 x 6 - 8	THD26-2	HHUS26-2, HTU26-2	14	3-7/16	5-3/8	3	2	--	18	16d	12	10d	2770	3125	3355	2340			
(2) 2 x 8 - 10	THD28-2	HHUS28-2, HTU28-2	14	3-7/16	7-1/8	3	2	--	28	16d	16	10d	4310	4860	5005	2595			
(2) 2 x 10 - 12	THD210-2	HHUS210-2, HTU210-2	14	3-7/16	9-1/8	3	2	--	38	16d	20	10d	5850	6600	7045	3905		IBC, FL, LA	
4 x 6 - 8	THD46	HHUS46	14	3-5/8	5-5/16	3	2	--	18	16d	12	10d	2770	3125	3355	2340			
4 x 8 - 10	THD48	HHUS48	14	3-5/8	7-1/16	3	2	--	28	16d	16	10d	4310	4860	5005	2595			
4 x 10 - 12	THD410	HHUS410	14	3-5/8	9-1/16	3	2	--	38	16d	20	10d	5850	6600	7045	3905			
4 x 12 - 14	THD412	--	14	3-5/8	11	3	3	--	48	16d	20	10d	7045	7045	7045	3905			
4 x 14 - 16	THD414	--	14	3-5/8	12-7/8	3	3	--	58	16d	20	10d	7045	7045	7045	3905			
(3) 2 x 10 - 12	THD210-3	HHUS210-3	12	5-1/8	9	3	3	--	38	16d	20	10d	6535	7255	7745	4010			
6 x 10 - 12	THD610	HHUS5.50/10	12	5-1/2	9	3	3	--	38	16d	20	10d	6535	7255	7745	4010			
6 x 12 - 14	THD612	--	12	5-1/2	11	3	3	--	48	16d	20	10d	8255	8860	8860	4010			
6 x 14 - 16	THD614	--	12	5-1/2	12-7/8	3	3	--	58	16d	20	10d	8860	8860	8860	4010			
(4) 2 x 10 - 12	THD210-4	HHUS210-4	12	6-3/4	9	3	3	--	38	16d	20	10d	6535	7255	7745	4010			
7 x 9-1/4 - 14	THD7210	HHUS7.25/10	12	7-1/4	9	3	3	--	38	16d	20	10d	6535	7255	7745	4010			

1) Uplift loads have been increased 60% for wind or seismic loads; no further increase shall be permitted.  
2) NAILS: 10d x 1-1/2 nails are 0.148" dia. x 1-1/2" long, 10d nails are 0.148" dia. x 3" long, 16d nails are 0.162" dia. x 3-1/2" long.

**Corrosion Finish** ■ Stainless Steel ■ Gold Coat ■ HDG ■ Triple Zinc

**Specialty Options Chart**

– refer to Specialty Options pages 283-284 for additional details.

Option	Skewed <sup>1,3</sup>	Sloped Seat <sup>2</sup>	Sloped / Skewed <sup>1,2,3</sup>	Inverted Flange
<b>Range</b>	1° to 45°	1° to 45°	See Sloped Seat and Skewed	Not available in widths < 3". Widths > 3" can have one flange inverted.
<b>Allowable Loads</b>	85% of table load	65% of table load	65% of table load	100% of table load. 65% of table load when nailing into the support members end grain.
<b>Ordering</b>	Add <i>SK</i> , angle required, right ( <i>R</i> ) or left ( <i>L</i> ), and square cut ( <i>SQ</i> ) or bevel cut ( <i>BV</i> ) to product number. Ex. THD410_SK45R_SQ	Add <i>SL</i> , slope required, and up ( <i>U</i> ) or down ( <i>D</i> ), to product number. Ex. THD410_SL30D	See Sloped Seat and Skewed. Ex. THD410_SK45R_SQ_SL30D	Add <i>IF</i> , one flange, right ( <i>R</i> ) and left ( <i>L</i> ), to product number. Ex. THD410_IFR

- 1) Skewed hangers with skews greater than 15° may have all joist nailing on outside flange.
- 2) Sloped or sloped / skewed hangers with slopes greater than 15° may have additional joist nails.
- 3) For skewed hangers, the required cut type (square or bevel) of joist member may vary based on skew angle and width of hanger. Some square cut hangers will require custom pricing due to welded back plate.

# THDH Heavy-Duty Truss Hangers



**Materials:** 12 gauge

**Finish:** G90 galvanizing

**Options:** See chart for Corrosion Finish Options and page 241 for Specialty Options chart

**Codes:** See page 12 for Code Reference Chart

**Installation:**

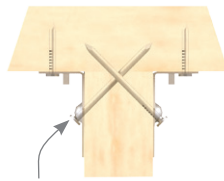
- Use all specified fasteners. See Product Notes, page 20.
- Joist nails must be driven in at a 30° to 45° angle through the joist or truss into the header to achieve listed loads. **Slant/double shear nails must be used to achieve listed load values.**
- See EWP applications pages 192-194.



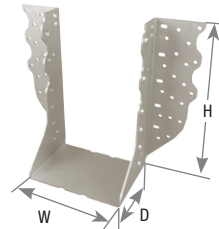
Typical THDH double shear installation



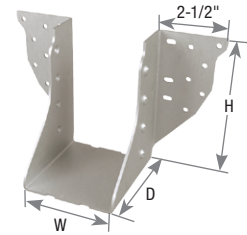
Typical THDH26-2 installation



Drive joist nails into header at 30° to 45° to achieve listed loads.



THDH



THDH26-2

Some model designs may vary from illustration shown

Plated Truss

Joist / Truss Size	MiTek USP Stock No.	Ref. No.	Dimensions (in)			Fastener Schedule <sup>3</sup>				DF/SP Allowable Loads (Lbs.)				S-P-F Allowable Loads (Lbs.)				Corrosion Finish	Code Ref.
			W	H	D	Header		Truss <sup>2</sup>		Floor	Roof	Uplift <sup>1</sup>	Floor	Roof	Uplift <sup>1</sup>				
						Qty	Type	Qty	Type							100%	115%		
2 x 6 - 8	THDH26	HGUS26	1-5/8	5-7/16	5	20	16d	8	16d	4375	4895	5245	2865	3850	4280	4280	2290		
2 x 8 - 10	THDH28	HGUS28	1-5/8	7-3/16	5	36	16d	12	16d	7595	8130	8130	4445	6240	6545	6545	3580		
2 x 10 - 12	THDH210	--	1-5/8	9-3/16	5	46	16d	16	16d	9310	9710	9710	5260	7255	7770	7870	4265		
2-11/16 x 9-1/4 - 14	THDH27925	--	2-3/4	9-1/8	4	46	16d	12	16d	9020	9020	9020	4445	7515	7900	7975	3560		
2-11/16 x 11-1/4 - 16	THDH27112	--	2-3/4	10-7/8	4	56	16d	14	16d	9710	9710	9710	4445	7795	7795	7795	3570		
2-11/16 x 14 - 16	THDH2714	--	2-3/4	12-1/4	4	66	16d	16	16d	11185	11760	11760	5260	8530	9045	9390	4235		
3-1/4 x 9-1/2	THDH3210	HGUS3.25/10	3-1/4	9-3/8	4	46	16d	12	16d	9020	9020	9020	4445	7955	7955	7955	3550		
3-1/4 x 10-5/8	THDH3212	HGUS3.25/12	3-1/4	10-5/8	4	56	16d	14	16d	9710	9710	9710	5260	7775	7775	7775	4210		IBC, FL, LA
(2) 2 x 6 - 8	THDH26-2	HGUS26-2	3-1/4	5-1/2	4	20	16d	8	16d	4375	4895	5245	2865	3850	4255	4255	2280		
(2) 2 x 8 - 10	THDH28-2	HGUS28-2	3-1/4	7-1/4	4	36	16d	10	16d	7360	8130	8130	3165	6475	6485	6485	2525		
(2) 2 x 10 - 12	THDH210-2	HGUS210-2	3-1/4	9-1/4	4	46	16d	12	16d	9020	9020	9020	4445	7965	7965	7965	3555		
4 x 6 - 8	THDH46	HGUS46	3-5/8	5-5/16	4	20	16d	8	16d	4375	4895	5245	2865	3850	4250	4250	2275		
4 x 8 - 10	THDH48	HGUS48	3-5/8	7-1/16	4	36	16d	10	16d	7360	8130	8130	3165	6470	6470	6470	2520		
4 x 10 - 12	THDH410	HGUS410	3-5/8	9-1/16	4	46	16d	12	16d	9020	9020	9020	4445	7950	7950	7950	3545		
4 x 12 - 14	THDH412	HGUS412	3-5/8	11-1/16	4	56	16d	14	16d	9710	9710	9710	5260	7765	7765	7765	4205		
4 x 14 - 16	THDH414	HGUS414	3-5/8	13-1/16	4	66	16d	16	16d	11760	11760	11760	5655	9420	9420	9420	4530		

1) Uplift loads have been increased 60% for wind or seismic loads; no further increase shall be permitted.  
 2) Joist nails need to be toe nailed at a 30° to 45° angle to achieve allowable loads shown.  
 3) **NAILS:** 16d nails are 0.162" dia. x 3-1/2" long.  
 New products or updated product information are designated in blue font.

**Corrosion Finish**  
■ Stainless Steel ■ Gold Coat  
■ HDG ■ Triple Zinc

Copyright © 2019 MiTek Industries, Inc. All Rights Reserved



Joist / Truss Size	MiTek USP Stock No.	Ref. No.	Dimensions (in)			Fastener Schedule <sup>3</sup>				DF/SP Allowable Loads (Lbs.)				S-P-F Allowable Loads (Lbs.)				Corrosion Finish	Code Ref.
			W	H	D	Header		Truss <sup>2</sup>		Floor		Roof		Floor		Roof			
						Qty	Type	Qty	Type	100%	115%	125%	160%	100%	115%	125%	160%		
(3) 2 x 6 - 8	THDH26-3	HGUS26-3	5-1/8	5-7/16	4	20	16d	8	16d	4375	4895	5245	2865	3850	4240	4240	2270		
(3) 2 x 8 - 10	THDH28-3	HGUS28-3	5-1/8	7-3/16	4	36	16d	12	16d	7595	8130	8130	4445	6465	6465	6465	3535		
(3) 2 x 10 - 12	THDH210-3	HGUS210-3	5-1/8	9-3/16	4	46	16d	16	16d	9710	9710	9710	5260	7750	7750	7750	4200		
(3) 2 x 12 - 14	THDH212-3	HGUS212-3	5-1/8	11-3/16	4	56	16d	20	16d	9740	9740	9740	5260	7800	7800	7800	4215		
(3) 2 x 14 - 16	THDH214-3	HGUS214-3	5-1/8	13-3/16	4	66	16d	22	16d	11760	11760	11760	5655	9430	9430	9430	4535		IBC, FL, LA
6 x 10 - 12	THDH610	HGUS5.25/10, HGUS5.50/10	5-1/2	9	4	46	16d	16	16d	9020	9020	9020	5260	7930	7930	7930	4190		
6 x 12 - 14	THDH612	HGUS5.25/12, HGUS5.50/12	5-1/2	11	4	56	16d	20	16d	9740	9740	9740	5260	7775	7775	7775	4200		
6 x 14 - 16	THDH614	HGUS5.50/14	5-1/2	13	4	66	16d	22	16d	11760	11760	11760	5655	9400	9400	9400	4520		
(4) 2 x 6 - 8	THDH26-4	HGUS26-4	6-9/16	5-7/16	4	20	16d	8	16d	4375	4895	5245	2865	3850	4230	4230	2265		IBC
(4) 2 x 8 - 10	THDH28-4	HGUS28-4	6-7/16	7-9/16	4	36	16d	12	16d	7595	8130	8130	4445	6445	6445	6445	3525		
6-3/4 x 9 - 14	THDH6710	HGUS210-4, HGUS6.88/10	6-7/8	8-13/16	4	46	16d	12	16d	9020	9020	9020	4445	7890	7890	7890	3520		
6-3/4 x 11 - 18	THDH6712	HGUS212-4, HGUS6.88/12	6-7/8	10-13/16	4	56	16d	14	16d	9020	9020	9020	5260	7900	7900	7900	4175		
6-3/4 x 13 - 20	THDH6714	HGUS214-4, HGUS6.88/14	6-7/8	12-13/16	4	66	16d	16	16d	11760	11760	11760	5655	9340	9340	9340	4490		IBC, FL, LA
7 x 9-1/4 - 14	THDH7210	HGUS7.25/10	7-1/4	9	4	46	16d	12	16d	9020	9020	9020	4445	7890	7890	7890	3520		
7 x 11-1/4 - 16	THDH7212	HGUS7.25/12	7-1/4	10-1/2	4	56	16d	14	16d	9020	9020	9020	5260	7900	7900	7900	4170		
7 x 14 - 20	THDH7214	HGUS7.25/14	7-1/4	12-1/4	4	66	16d	16	16d	11760	11760	11760	5655	9335	9335	9335	4490		

- 1) Uplift loads have been increased 60% for wind or seismic loads; no further increase shall be permitted.  
 2) Joist nails need to be toe nailed at a 30° to 45° angle to achieve allowable loads shown.  
 3) **NAILS:** 16d nails are 0.162" dia. x 3-1/2" long.

**Corrosion Finish**

- Stainless Steel ■ Gold Coat  
 ■ HDG ■ Triple Zinc

**Specialty Options Chart**

– refer to Specialty Options pages 283-284 for additional details.

Option	Skewed <sup>1,3</sup>	Sloped Seat <sup>2</sup>	Sloped / Skewed <sup>1,2,3</sup>
Range	1° to 45°	1° to 45°	See Sloped Seat and Skewed
Allowable Loads	85% of table allowable load. 50% of table uplift load.	85% of table allowable load	52% of table allowable load. 50% of table uplift load.
Ordering	Add <i>SK</i> , angle required, right ( <i>R</i> ) or left ( <i>L</i> ), and square cut ( <i>SQ</i> ) or bevel cut ( <i>BV</i> ) to product number. Ex. THDH410_SK45R_BV	Add <i>SL</i> , slope required, and up ( <i>U</i> ) or down ( <i>D</i> ), to product number. Ex. THDH410_SL30D	See Sloped Seat and Skewed. Ex. THDH410_SK45R_BV_SL30D

- 1) Skewed THDH hangers with skews greater than 15° always have all joist nailing on one side of the outside flange.  
 2) Sloped or sloped / skewed hangers with slopes greater than 15° may have additional joist nails.  
 3) Skewed hangers typically require a bevel cut however, a square cut option may be available as a custom when requested.  
**Inverted flange option is not available for THDH models.**

The THDHQ hangers are designed to attach multi-ply girder trusses together using MiTek's WS Wood Screws for higher design load capacity. THDHQ hangers can also be used to attach structural composite lumber (SCL).

**Materials:** 12 gauge

**Finish:** G90 galvanizing

**Codes:** See page 12 for Code Reference Chart

**Installation:**

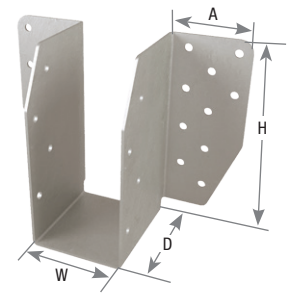
- Use all specified fasteners.
- WS Wood Screws are supplied with THDHQ hangers.



**Typical THDHQ28-2 truss installation**



**Typical THDHQ28-2 SCL installation**



**THDHQ28-2**

Joist / Truss Size	MiTek USP Stock No.	Ref. No.	Dimensions (in)				Fastener Schedule <sup>2,3</sup>				DF/SP Allowable Loads (Lbs.)				S-P-F Allowable Loads (Lbs.)				Code Ref.
			W	H	D	A	Supporting Member <sup>5</sup>		Supported Member		Floor	Roof	Uplift <sup>1</sup>	Floor	Roof	Uplift <sup>1</sup>			
							Qty	Type	Qty <sup>4</sup>	Type							100%	115%	
<b>Double 2x Sizes</b>																		IBC, FL, LA	
(2) 2 x 6 - 8	THDHQ26-2	--	3-5/16	5-7/16	4	1-15/16	12	WS3	4	WS3	5015	5745	5745	2015	4405	4560	4560		1600
(2) 2 x 8 - 10	THDHQ28-2	--	3-5/16	7-3/16	4	2-13/16	20	WS3	8	WS3	8355	9610	10165	3645	7340	8140	8140		2920
(2) 2 x 10 - 12	THDHQ210-2	--	3-5/16	9-3/16	4	2-13/16	28	WS3	8	WS3	10840	10880	10880	5345	8035	8475	8715	4500	
<b>Triple 2x Sizes</b>																		IBC, FL, LA	
(3) 2 x 6 - 8	THDHQ26-3	--	4-15/16	5-7/16	4	1-15/16	12	WS45	4	WS45	5015	5745	5745	2015	4405	4545	4545		1595
(3) 2 x 8 - 10	THDHQ28-3	--	4-15/16	7-3/16	4	2-13/16	20	WS45	8	WS45	8355	9610	10165	3645	7340	8095	8095		2900
(3) 2 x 10 - 12	THDHQ210-3	--	4-15/16	9-3/16	4	2-13/16	28	WS45	8	WS45	10880	10880	10880	5345	8665	8665	8665	4475	
<b>Quadruple 2x Sizes</b>																		IBC, FL, LA	
(4) 2 x 6 - 8	THDHQ26-4	--	6-9/16	5-7/16	4	1-15/16	12	WS6	4	WS6	5015	5745	5745	2600	4405	4535	4535		2050
(4) 2 x 8 - 10	THDHQ28-4	--	6-9/16	7-3/16	4	2-13/16	20	WS6	8	WS6	8355	9610	10165	4830	7340	8070	8070		3830
(4) 2 x 10 - 12	THDHQ210-4	--	6-9/16	9-3/16	4	2-13/16	28	WS6	8	WS6	10880	10880	10880	4440	8635	8635	8635	3525	
<b>4x Sizes</b>																		IBC, FL, LA	
4 x 6 - 8	THDHQ46	--	3-5/8	5-7/16	4	1-15/16	12	WS3	8	WS3	5015	5745	5745	2015	4405	4590	4590		1610
4 x 8 - 10	THDHQ48	--	3-5/8	7-3/16	4	2-13/16	20	WS3	8	WS3	8355	9610	10165	3645	7340	8120	8120		2910
4 x 10 - 12	THDHQ410	--	3-5/8	9-3/16	4	2-13/16	28	WS3	8	WS3	10880	10880	10880	5345	8690	8690	8690	4490	

- 1) Uplift loads have been increased 60% for wind or seismic loads; no further increase shall be permitted.
- 2) WS3 is 1/4" dia. x 3" long wood screw, WS45 is 1/4" dia. x 4-1/2" long wood screw, WS6 is 1/4" dia. x 6" long wood screw and are included with THDHQ hangers.
- 3) WS Wood Screws may be installed through metal truss connector plates as approved by truss designer per ANSI/TPI 1-2007 Section 7.5.3.4 and 8.9.2. Pre-drilling required through the plate using a maximum of 5/32" bit.
- 4) Wood screws specified for supported member must ALL be installed into the supported member while maintaining a minimum 5/8" edge distance where truss connector plates are not present.
- 5) When fastening to a multi-ply supporting truss: use WS3 for 2-ply, WS45 for 3-ply and WS6 for 4-ply.

The MSH is field adjustable. The flanges can be used in top mount, face mount, or combination installations. An open back design allows installation after a member is placed in position.

**Materials:** See chart

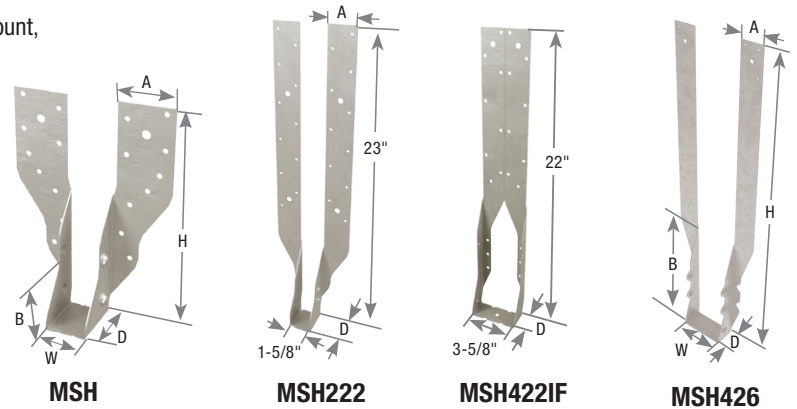
**Finish:** G90 galvanizing

**Options:** See chart for Corrosion Finish Options on pages 244-245 and Nailer Options Chart below

**Codes:** See page 12 for Code Reference Chart

**Installation:**

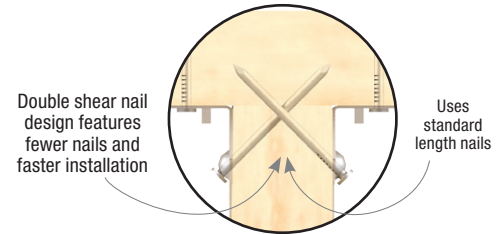
- Use all specified fasteners. See Product Notes, page 20.
- Web stiffeners are required for I-Joist installations.



**Nailer Options**

– chart represents maximum allowable loads for hangers used on wood nailers. Reference page 183.

MiTek USP Series	Nailer Size	Fastener Schedule <sup>2</sup>				Allowable Loads (Lbs.) <sup>1</sup>	
		Nailer		Joist		DF/SP 100%	S-P-F 100%
		Qty	Type	Qty	Type		
MSH (18 gauge)	2X	4	10d x 1-1/2	4	10d x 1-1/2	1245	1045
	3X	4	10d x 1-1/2	4	10d x 1-1/2	1245	1045
	(2) 2X	6	10d	4	10d x 1-1/2	1950	1640
	4X	6	10d	4	10d x 1-1/2	1950	1640
MSH (16 or 14 gauge)	2X	6	10d x 1-1/2	6	10d x 1-1/2	2025	1700
	3X	6	10d x 1-1/2	6	10d x 1-1/2	2025	1700
	(2) 2X	6	16d x 2-1/2	6	10d x 1-1/2	2025	1700
	4X	6	16d x 2-1/2	6	10d x 1-1/2	2025	1700



- 1) Listed loads shall not be increased.
- 2) **NAILS:** 10d x 1-1/2 nails are 0.148" dia. x 1-1/2" long, 10d nails are 0.148" dia. x 3" long, 16d x 2-1/2 nails are 0.162" dia. x 2-1/2" long.

**Mounting Conditions**

Face Max	Top-Max	Top-Min	Combination Face-Max / Top-Max
<p>All header nails used should be driven into the wide face of the header.</p> <p><b>Typical MSH face-max installation</b></p>	<p>The hanger is installed in a top mount condition with at least six lowest header face nail holes filled, and four top flange nails filled. Refer to <b>Table 1</b> below for minimum top flange length requirements.</p> <p><b>Typical MSH top-max installation</b></p>	<p>The hanger is installed in a top mount condition with at least the top two header face nail holes filled, and four top flange nail holes filled. Refer to <b>Table 1</b> below for minimum top flange length requirements. The joist nails shall be installed straight into the joist for all models.</p> <p><b>Typical MSH top-min installation</b></p>	<p>Face-Max values apply for the entire connection. Follow fastening directions for the applicable mounting condition for each individual flange strap.</p> <p><b>Typical MSH combination installation</b></p>

**Table 1**

Minimum Top Flange Length for Top Mount Installations <sup>1</sup>											
7/8"	1-1/8"	1-3/8"	1-1/2"	1-3/4"	1-7/8"	2"	2-3/16"	2-5/8"	2-3/4"	2-13/16"	
MSH426	MSH29	MSH2322-2	MSH422-2	MSH426-2	MSH1713	MSH424	MSH222	MSH222-2	MSH218-2	MSH218	MSH213
MSH426IF	--	MSH2622-2	MSH422-2IF	--	--	--	MSH1722	MSH422IF	--	MSH413	--
--	--	--	--	--	--	--	MSH2322	MSH2022	--	MSH418	--
--	--	--	--	--	--	--	MSH322	--	--	MSH422	--

1) Total hanger height will be reduced by the top flange length. Carried member height must be accounted for accordingly.

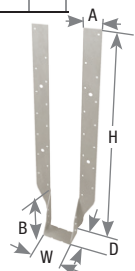
Plated Truss Chart

Joist Material & Width	MiTek USP Stock No.	Ref. No.	Steel Gauge	Dimensions (in)					Mounting Condition	Fastener Schedule <sup>2</sup>					DF/SP Allowable Loads (Lbs.)				S-P-F Allowable Loads (Lbs.)			Corrosion Finish
				W	D	H	A	B		Header		Joist			Floor	Roof	Uplift <sup>1</sup>	100%	115%	125%	160%	
										Top Qty	Face Qty	Type	Qty	Type								
				100%	115%	125%	160%	100%		115%	125%	160%										
2x Lumber or Trusses	MSH29	THA29	18	1-5/8	2-1/4	8-3/4	2-7/16	5	face-max	--	18	10d	4	10d	2440	2440	2440	715	1955	1955	1955	575
									top-max	4	6	10d	4	10d	2865	2865	2865	715	2200	2290	2290	570
									top-min	4	2	10d	4	10d x 1-1/2	2335	2335	2335	--	1845	1845	1845	--
	MSH213	THA213	18	1-5/8	2-1/4	12-3/4	2-3/8	5	face-max	--	20	10d	4	10d	2440	2440	2440	715	1955	1955	1955	575
									top-max	4	6	10d	4	10d	2865	2865	2865	715	2200	2290	2290	570
									top-min	4	2	10d	4	10d x 1-1/2	2335	2335	2335	--	1845	1845	1845	--
	MSH218	THA218	18	1-5/8	2-1/4	16-3/4	2-7/16	5	face-max	--	26	10d	4	10d	2440	2440	2440	715	1955	1955	1955	575
									top-max	4	6	10d	4	10d	2865	2865	2865	715	2200	2290	2290	570
									top-min	4	2	10d	4	10d x 1-1/2	2335	2335	2335	--	1845	1845	1845	--
	MSH222	THA222	18	1-5/8	1-3/4	23	1-13/16	10-13/16	face-max	--	22	10d	4	10d x 1-1/2	2120	2190	2230	715	1540	1595	1635	575
									top-max	4	6	10d	4	10d x 1-1/2	2120	2190	2230	715	1540	1595	1635	575
									top-min	4	2	10d	4	10d x 1-1/2	2120	2190	2230	--	1540	1595	1635	--
2-1/2" wide Floor Trusses	MSH322	THA322	18	2-9/16	1-3/4	22-1/2	1-13/16	10-3/8	face-max	--	22	10d	4	10d x 1-1/2	2275	2275	2275	715	1815	1815	1815	570
									top-max	4	6	10d	4	10d x 1-1/2	2855	2855	2855	715	2280	2280	2280	570
									top-min	4	2	10d	4	10d x 1-1/2	2175	2175	2175	--	1720	1720	1720	--
(2) 2x Lumber or Trusses	MSH218-2	THA218-2	16	3-1/8	1-3/4	17-3/4	1-13/16	10-1/16	face-max	--	16	10d	4	10d	2000	2245	2420	675	1760	1975	2130	540
									top-max	4	6	10d	4	10d	3485	3575	3575	675	2520	2600	2660	540
									top-min	4	2	10d	4	10d	2435	2435	2435	--	2080	2105	2125	--
	MSH222-2	THA222-2	16	3-1/8	1-3/4	22-1/4	1-13/16	10-1/16	face-max	--	22	10d	4	10d	2750	3085	3330	675	2420	2675	2675	540
									top-max	4	6	10d	4	10d	3485	3575	3575	675	2520	2600	2660	540
									top-min	4	2	10d	4	10d	2435	2435	2435	--	2080	2105	2125	--
3-1/2" wide Floor Trusses	MSH413	THA413	16	3-9/16	1-3/4	14	1-7/8	7-5/8	face-max	--	14	10d	6	10d	2340	2640	2855	1815	2055	2325	2490	1450
									top-max	4	6	10d	6	10d	3575	3575	3575	1815	2855	2855	2855	1450
									top-min	4	2	10d	6	10d	2355	2355	2355	--	1865	1865	1865	--
	MSH418	THA418	16	3-9/16	1-3/4	17-1/2	1-7/8	7-5/8	face-max	--	18	10d	6	10d	2840	3200	3460	1815	2495	2815	3040	1450
									top-max	4	6	10d	6	10d	3575	3575	3575	1815	2855	2855	2855	1450
									top-min	4	2	10d	6	10d	2355	2355	2355	--	1865	1865	1865	--
	MSH422	THA422, THAI422	16	3-9/16	1-3/4	21-1/2	1-7/8	7-5/8	face-max	--	22	10d	6	10d	3340	3765	4065	1815	2935	3250	3250	1450
									top-max	4	6	10d	6	10d	3525	3575	3575	1815	2665	2825	2855	1450
									top-min	4	2	10d	6	10d	2355	2355	2355	--	1865	1865	1865	--
	MSH422IF	THAC418, THAC422	16	3-5/8	1-3/4	22	--	9-13/16	face-max	--	22	10d	4	10d	2750	3085	3330	675	2420	2715	2930	540
									top-max	4	6	10d	4	10d	3485	3575	3575	675	2520	2600	2660	540
									top-min	4	2	10d	4	10d	2355	2355	2355	--	1865	1865	1865	--
	MSH424	--	16	3-5/8	2	21-1/2	2-1/16	5-3/16	face-max	--	36	10d	6	10d	5090	5595	5595	1815	4150	4310	4420	1445
									top-max	4	6	10d	6	10d	3575	3575	3575	1815	2845	2845	2845	1445
									top-min	4	2	10d	6	10d	2355	2355	2355	--	1860	1860	1860	--
	MSH426	THA426	14	3-5/8	1-3/4	26	1-13/16	8	face-max	--	38	16d	6	16d	5455	5595	5595	1815	4035	4230	4360	1455
									top-max	4	8	16d	6	16d	3760	3760	3760	1735	3010	3010	3010	1385
									top-min	4	2	16d	6	16d	2435	2435	2435	--	2160	2160	2160	--
MSH426IF	THAC426	14	3-5/8	1-3/4	26	--	8	face-max	--	38	16d	6	16d	5455	5595	5595	1815	4035	4230	4360	1455	
								top-max	4	8	16d	6	16d	3760	3760	3760	1735	3010	3010	3010	1385	
								top-min	4	2	16d	6	16d	2435	2435	2435	--	2160	2160	2160	--	
(2) 3-1/2" wide Floor Trusses	MSH422-2	THA422-2	14	7-1/4	2	22-1/8	2-1/8	11	face-max	--	26	16d	6	16d	4005	4515	4845	1380	3520	3970	4260	1215
									top-max	4	10	16d	6	16d	4665	4860	4990	1380	3480	3650	3765	1215
									top-min	4	4	16d	6	16d	3740	3755	3755	--	2665	2735	2780	--
	MSH422-2IF	THAC422-2	14	7-1/4	2	22-1/8	--	11	face-max	--	26	16d	6	16d	4005	4515	4845	1380	3520	3970	4260	1215
									top-max	4	10	16d	6	16d	4665	4860	4990	1380	3480	3650	3765	1215
									top-min	4	4	16d	6	16d	3740	3755	3755	--	2665	2735	2780	--
MSH426-2	THA426-2	14	7-1/4	2	26-1/16	2-1/8	11	face-max	--	26	16d	6	16d	4005	4515	4845	1380	3520	3970	4260	1215	
								top-max	4	10	16d	6	16d	4665	4860	4990	1380	3480	3650	3765	1215	
								top-min	4	4	16d	6	16d	3740	3755	3755	--	2665	2735	2780	--	

1) Uplift loads have been increased 60% for wind or seismic loads; no further increase shall be permitted.

2) NAILS: 10d x 1-1/2" nails are 0.148" dia. x 1-1/2" long, 10d nails are 0.148" dia. x 3" long, 16d nails are 0.162" dia. x 3-1/2" long.

Corrosion Finish ■ Stainless Steel ■ Gold Coat ■ HDG ■ Triple Zinc

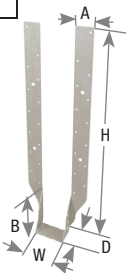


I-Joist, LVL, LSL & PSL Chart

Joist Material & Width	MiTek USP Stock No.	Ref. No.	Steel Gauge	Dimensions (in)					Mounting Condition	Fastener Schedule <sup>2</sup>				DF/SP Allowable Loads (Lbs.)				S-P-F Allowable Loads (Lbs.)				Corrosion Finish	Code Ref.	
				W	D	H	A	B		Header		Joist		Floor	Roof	Uplift <sup>1</sup>	Floor	Roof	Uplift <sup>1</sup>					
										Top Qty	Face Qty	Type	Qty							Type	100%			115%
2x Lumber or Trusses	MSH222	THAI222	18	1-5/8	1-3/4	23	1-13/16	10-13/16	face-max	--	22	10d	4	10d x 1-1/2	2120	2190	2230	715	1540	1595	1635	575		
									top-max	4	6	10d	4	10d x 1-1/2	2120	2190	2230	715	1540	1595	1635	575		
									top-min	4	2	10d	4	10d x 1-1/2	2120	2190	2230	--	1540	1595	1635	--		
1-3/4" LVL or I-Joist	MSH1713	--	18	1-13/16	1-3/4	14-7/16	1-13/16	10-3/4	face-max	--	12	10d	4	10d	1440	1640	1770	715	1265	1445	1555	575		
									top-max	4	6	10d	4	10d	2395	2460	2505	715	1725	1785	1820	575		
									top-min	4	2	10d	4	10d x 1-1/2	2335	2335	2335	--	1725	1785	1820	--		
	MSH1722	THAI1.81/22	18	1-13/16	1-3/4	22-7/8	1-7/8	10-3/4	face-max	--	22	10d	4	10d x 1-1/2	2280	2280	2280	715	1725	1785	1820	575		
									top-max	4	6	10d	4	10d x 1-1/2	2395	2460	2505	715	1725	1785	1820	575		
									top-min	4	2	10d	4	10d x 1-1/2	2335	2335	2335	--	1725	1785	1820	--		
2" wide I-Joist	MSH2022	THAI2.06/22	18	2-1/16	1-3/4	22-5/8	1-13/16	10-7/16	face-max	--	22	10d	4	10d	2275	2275	2275	715	1815	1815	1815	570		
									top-max	4	6	10d	4	10d	2670	2735	2780	715	1910	1970	2005	570		
									top-min	4	2	10d	4	10d	2335	2335	2335	--	1845	1845	1845	--		
2-5/16" wide I-Joist	MSH2322	THAI3522	18	2-3/8	1-3/4	22-5/8	1-13/16	10-7/16	face-max	--	22	10d	4	10d x 1-1/2	2275	2275	2275	715	1815	1815	1815	570		
									top-max	4	6	10d	4	10d x 1-1/2	2855	2855	2855	715	2140	2200	2240	570		
									top-min	4	2	10d	4	10d x 1-1/2	2175	2175	2175	--	1720	1720	1720	--		
2-1/2" wide Floor Trusses	MSH322	THAI322	18	2-9/16	1-3/4	22-1/2	1-13/16	10-3/8	face-max	--	22	10d	4	10d x 1-1/2	2275	2275	2275	715	1815	1815	1815	570		
									top-max	4	6	10d	4	10d x 1-1/2	2855	2855	2855	715	2280	2280	2280	570		
									top-min	4	2	10d	4	10d x 1-1/2	2175	2175	2175	--	1720	1720	1720	--		
3-1/2" wide Floor Trusses	MSH413	THA413	16	3-9/16	1-3/4	14	1-7/8	7-5/8	face-max	--	14	10d	6	10d	2340	2640	2855	1815	2055	2325	2490	1450		
									top-max	4	6	10d	6	10d	3575	3575	3575	1815	2855	2855	2855	1450		
									top-min	4	2	10d	6	10d	2355	2355	2355	--	1865	1865	1865	--		
	MSH418	THA418	16	3-9/16	1-3/4	17-1/2	1-7/8	7-5/8	face-max	--	18	10d	6	10d	2840	3200	3460	1815	2495	2815	3040	1450		
									top-max	4	6	10d	6	10d	3575	3575	3575	1815	2855	2855	2855	1450		
									top-min	4	2	10d	6	10d	2355	2355	2355	--	1865	1865	1865	--		
	MSH422	THA422, THAI422	16	3-9/16	1-3/4	21-1/2	1-7/8	7-5/8	face-max	--	22	10d	6	10d	3340	3765	4065	1815	2935	3250	3250	1450		
									top-max	4	6	10d	6	10d	3525	3575	3575	1815	2665	2825	2855	1450		
									top-min	4	2	10d	6	10d	2355	2355	2355	--	1865	1865	1865	--		
	MSH422IF	THAC418, THAC422	16	1-3/4	22	--	9-13/16	face-max	--	22	10d	4	10d	2750	3085	3330	675	2420	2715	2930	540			
								top-max	4	6	10d	4	10d	3485	3575	3575	675	2520	2600	2660	540			
								top-min	4	2	10d	4	10d	2355	2355	2355	--	1865	1865	1865	--			
MSH424	--	16	3-5/8	2	21-1/2	2-1/16	5-3/16	face-max	--	36	10d	6	10d	5090	5595	5595	1815	4150	4310	4420	1445			
								top-max	4	6	10d	6	10d	3575	3575	3575	1815	2845	2845	2845	1445			
								top-min	4	2	10d	6	10d	2355	2355	2355	--	1860	1860	1860	--			
MSH426	THA426	14	3-5/8	1-3/4	26	1-13/16	8	face-max	--	38	16d	6	16d	5455	5595	5595	1815	4035	4230	4360	1455			
								top-max	4	8	16d	6	16d	3760	3760	3760	1735	3010	3010	3010	1385			
								top-min	4	2	16d	6	16d	2435	2435	2435	--	2160	2160	2160	--			
MSH426IF	THAC426	14	3-5/8	1-3/4	26	--	8	face-max	--	38	16d	6	16d	5455	5595	5595	1815	4035	4230	4360	1455			
								top-max	4	8	16d	6	16d	3760	3760	3760	1735	3010	3010	3010	1385			
								top-min	4	2	16d	6	16d	2435	2435	2435	--	2160	2160	2160	--			
4-5/8" wide I-Joist	MSH2322-2	--	16	4-3/4	1-3/4	22	1-7/8	9-1/4	face-max	--	46	10d	4	10d	5560	5595	5595	675	3880	3935	3970	535		
									top-max	4	6	10d	4	10d	3485	3575	3575	675	2520	2600	2660	535		
									top-min	4	2	10d	4	10d	2355	2355	2355	--	1865	1865	1865	--		
	MSH2622-2	--	16	5-3/8	1-3/4	22	1-7/8	9-1/4	face-max	--	46	10d	4	10d	5560	5595	5595	675	3880	3935	3970	535		
									top-max	4	6	10d	4	10d	3485	3575	3575	675	2520	2600	2660	535		
									top-min	4	2	10d	4	10d	2355	2355	2355	--	1865	1865	1865	--		

1) Uplift loads have been increased 60% for wind or seismic loads; no further increase shall be permitted.  
 2) **NAILS:** 10d x 1-1/2 nails are 0.148" dia. x 1-1/2" long, 10d nails are 0.148" dia. x 3" long, 16d nails are 0.162" dia. x 3-1/2" long.

**Corrosion Finish** ■ Stainless Steel ■ Gold Coat ■ HDG ■ Triple Zinc



Copyright © 2019 MiTek Industries, Inc. All Rights Reserved

Plated Truss

IBC, FL, LA

# MSHL/R Skewed Truss Hangers



The MSHL/R is a versatile 45° skewed hanger with multiple installation options. It can be installed on a supporting girder truss as well as solid-sawn and structural composite lumber headers.

**Materials:** See chart

**Finish:** G90 galvanizing

**Codes:** See page 12 for Code Reference Chart

**Installation:**

- Install the required number of fasteners according to the load table.
- Install fasteners into the carrying members at the locations described below based on the proper "Mounting Condition."
- Web stiffeners are required for I-Joist installations.
- Hanger is factory skewed at 45° left or right.

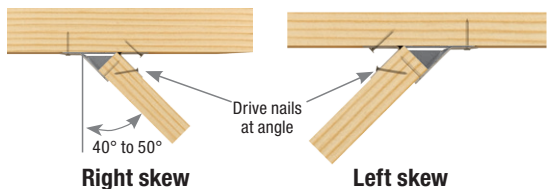


Typical MSH213R installation

Right skew

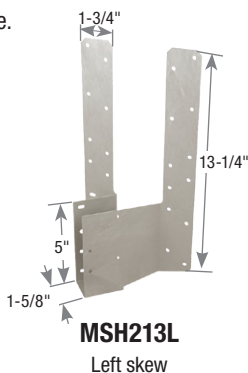
Typical MSH213L installation

Left skew



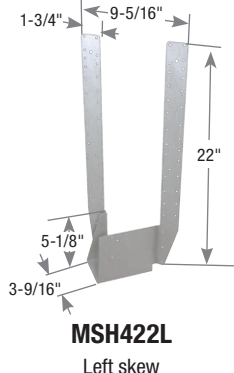
Right skew

Left skew



MSH213L

Left skew



MSH422L

Left skew



MSH422R

Right skew

## CONNECTION TO CARRYING MEMBER – Mounting Condition

### Face-Max

For MSH422L/R, the bottom six (6) fastener holes (three on each side of the bucket) must be filled. Install eight additional fasteners (four (4) in each strap) where applicable. For MSH213L/R, the bottom eight (8) fastener holes must be filled (four (4) in each strap). Install fourteen (14) additional fasteners, seven (7) in each strap. Min. 2x6 bottom chord required.



Typical MSHL/R face-max installation

### Top-Max

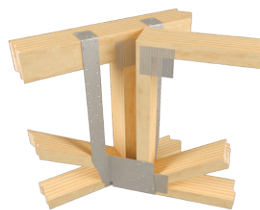
The straps must be field-bent over the header a minimum of 2" to allow four (4) top flange nail holes to be filled (two in each strap). The bottom six (6) fastener holes (three on each side of the bucket) must be filled. Min. 2x6 bottom chord required.



Typical MSHL/R top-max installation

### Top-Min

The straps must be field bent over the header a minimum of 2" to allow four (4) top flange nail holes to be filled (two in each strap). Also install the two (2) uppermost face nails (one on each strap) near the top of the header.



Typical MSHL/R top-min installation

### Combination Face-Max/Top-Max

Follow the Face-Max installation for one side of the connector and the Top-Max installation for the opposite side of the connector. The Face-Max allowable loads apply to this type of installation. Min. 2x6 bottom chord required.



Typical MSHL/R combination installation

## CONNECTION TO CARRIED MEMBER – All Mounting Conditions

Install six (6) 10d x 1-1/2" nails into 2x carried member, or six (6) 10d nails into 3-1/2" wide carried member.

Joist Material & Width	MiTek USP Stock No.	Ref. No.	GA	Mounting Condition	Fastener Schedule <sup>2</sup>					DF/SP Allowable Loads (Lbs.)				S-P-F Allowable Loads (Lbs.)				Code Ref.
					Header		Joist			Download				Uplift <sup>1</sup>				
					Top Qty	Face Qty	Type	Qty	Type	100%	115%	125%	160%	100%	115%	125%	160%	
2x Lumber or Trusses	MSH213L/R	--	18	face-max	--	22	10d	6	10d x 1-1/2	1620	1620	1620	670	1310	1310	1310	540	IBC, FL, LA
				top-max	4	6	10d	6	10d x 1-1/2	1770	1770	1770	670	1425	1425	1425	540	
				top-min	4	2	10d	6	10d x 1-1/2	1325	1325	1325	--	1210	1210	1210	--	
				combination	2	14	10d	6	10d x 1-1/2	1620	1620	1620	670	1310	1310	1310	540	
3-1/2" LVL or Floor Trusses	MSH422L/R	THAL/R422	16	face-max	--	14	10d	6	10d	1750	1755	1755	560	1395	1395	1395	445	IBC, FL
				top-max	4	6	10d	6	10d	1820	1820	1820	560	1490	1490	1490	445	
				top-min	4	2	10d	6	10d	1385	1385	1385	--	1100	1100	1100	--	
				combination	2	10	10d	6	10d	1750	1755	1755	560	1395	1395	1395	445	

1) Uplift loads have been increased 60% for wind or seismic loads; no further increase shall be permitted.

2) **NAILS:** 10d x 1-1/2" nails are 0.148" dia. x 1-1/2" long, 10d nails are 0.148" dia. x 3" long. New products or updated product information are designated in **blue font**.

MiTek's MSSH217 hanger accommodates a skew range of 60° to 85° (30° maximum off the girder) without the need for a more expensive custom design hanger. Face nail to webs or bend the flange strap over the chord. Available in left (L) or right (R) configurations.

**Materials:** 18 gauge

**Finish:** G90 galvanizing

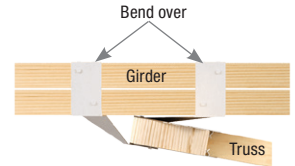
**Codes:** See page 12 for Code Reference Chart

**Installation:**

- Use all specified fasteners. See Product Notes, page 20.
- The 3 lower holes on each strap are for top nailing when the strap is bent over the truss chord. These holes are not for face nailing.
- One or both straps may be bent over the bottom chord of the girder with top or backside nailing.
- **Note:** Select the correct (right or left) hanger so that the strap on the outside of the angle will pass the end of the truss. When facing the hanger, the strap in the rear turns in the direction of the skew. The front strap turns to pass behind the end of the carried member.
- Attach the hanger at the end of the truss with a single 10d (0.148" dia.) x 1-1/2" nail into the side flange or bottom.
- Place the truss in position against the girder. Push the outside strap past the end of the truss to the girder web and face nail through the top 8 holes with 10d (0.148" dia.) x 1-1/2" nails for a 1-ply girder, or 10d (0.148" dia. x 3") common nails for multiple-ply girders.
- The strap inside the angle can be formed over diagonal webs (if design allows) or bend over the girder chord. Use two nails into the top and/or back side of the girder.
- If the outside strap does not contact a web, bend the strap tightly over the girder chord. Use two nails into the top and/or back side of the girder.
- For uplift resistance, other means of attachment are required. If both the truss and girder have vertical webs, attach a scab to pack out the girder web nearly flush with the truss web and use a field adjustable MP framing angle across the two. A top chord connection for uplift requires a flat LSTA strap tie wrapped under the girder and over the truss chord.



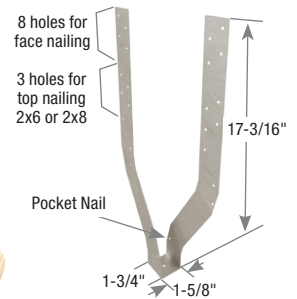
**MSSH217L**  
Left shown attached to web and top of chord



**Top view right shown**

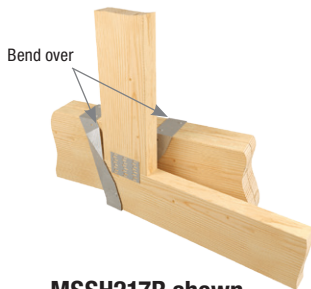


**MSSH217R**  
Right shown attached to webs

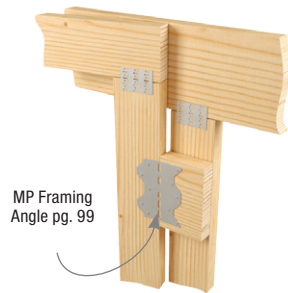


**MSSH217R**  
Right shown

Plated Truss



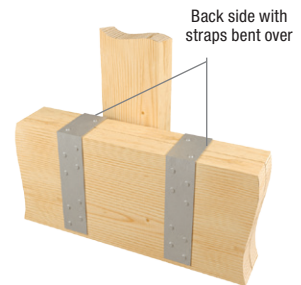
**MSSH217R shown bent over bottom chord**



**Additional strapping for high uplift**



**Additional strapping for high uplift**



**Back view shown**

Copyright © 2019 MiTek Industries, Inc. All Rights Reserved

MiTek USP Stock No.	Ref. No.	Steel Gauge	Mounting Condition	Fastener Schedule <sup>2,3,5</sup>						Girder Truss	DF/SP Allowable Loads (Lbs.) <sup>1</sup>			S-P-F Allowable Loads (Lbs.) <sup>1</sup>			Code Ref.
				Supporting Member				Supported Member <sup>4</sup>			Floor	Roof		Floor	Roof		
				Top		Face/Backside						100%	115%		100%	115%	
				Qty	Type	Qty	Type	Qty	Type								
MSSH217L/R	--	18	face-max	--	--	16	10d	1	10d x 1-1/2	1 Ply	1755	1770	1770	1140	1155	1165	--
			top-min	4	10d	6	10d			1 Ply	1735	1735	1735	1140	1155	1165	

1) No uplift value with this hanger. Use other hardware or nailing higher on supported member to counteract uplift.  
 2) One or both straps may be bent over bottom chord of girder with top or backside nailing.  
 3) Maintain minimum 3/4" edge distance when installing nails.  
 4) The supported member shall be supported by blocking or other means to prevent rotation.  
 5) **NAILS:** 10d x 1-1/2" nails are 0.148" dia. x 1-1/2" long, 10d nails are 0.148" dia. x 3" long.  
**Note: The 3 lower holes on each strap are for top nailing when strap is bent. These holes are not for face nailing.**

MiTek's MSHA Series hanger offers the most flexible field solution for truss-to-truss connections accommodating a range of skews and challenging web-chord geometry often found in truss framing. Eliminating the need for special orders, the MSHA Series hanger provides economical solutions for 1-ply or 2-ply roof trusses and 1-ply floor trusses skewed between 22-1/2° to 75°. MSHA hangers can be installed in top-min, top-max, face-max, or combination mounting conditions as required.

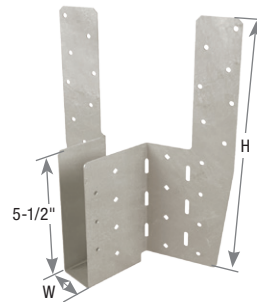
**Materials:** 16 gauge

**Finish:** G90 galvanizing

**Codes:** See page 12 for Code Reference Chart

**Installation:**

- Install the required number of fasteners according to the load table.
- Install fasteners into the carrying member at the locations described below based on the proper "Mounting Condition".
- Product is factory skewed 22-1/2° and may be field skewed from 22-1/2° to 75°. See installation sequence on page 197 for skews greater than 22-1/2°.
- Face-Max and Combination mounting conditions require a minimum chord or header height of 7-1/4". Top-Max and Top-Min mounting conditions require a minimum chord or header height of 5-1/2".



**MSHA29L**  
Left Shown



**MSHA29R-2**  
Right Shown

Plated Truss

**CONNECTION TO CARRYING MEMBER**  
Mounting Conditions:

**Face-Max**

Fill the lowest four holes nearest each side of the bucket. For a 22-1/2° skew, fill the four diamond holes on one side and 4 round holes on the other. For skews greater than 22-1/2°, fill the 4 round holes on each side.

Add an equal amount of nails in each side of the hanger in any of the remaining nail holes to meet the minimum fastener requirements listed in the table on page 249.



**Typical MSHA**  
face-max installation

**Top-Max**

Field bend the strap over the supporting member. The bent strap must extend a minimum of 2" over the carrying member to allow for the four top flange nail holes to be filled.

Fill the lowest four nail holes nearest each side of the bucket. For a 22-1/2° skew, fill the four diamond holes on one side and 4 round holes on the other. For skews greater than 22-1/2°, fill the 4 round holes on each side.

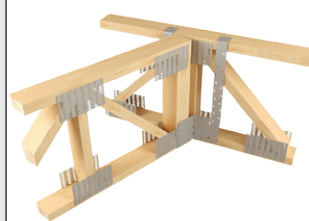


**Typical MSHA**  
top-max installation

**Top-Min**

Field bend the strap over the supporting member. The bent strap must extend a minimum of 2" over the carrying member to allow for the four top flange nail holes to be filled.

Fill the four nail holes (two each strap) nearest the top of the carrying member.



**Typical MSHA**  
top-min installation

**Combination**  
Face-Max/Top-Max

Follow the Face-Max installation for one side of the connector. Follow the Top-Max installation for the opposite side of the connector. The Face-Max allowable loads apply to this type of installation.



**Typical MSHA**  
combination installation

**CONNECTION TO CARRIED MEMBER**  
Mounting Conditions:

For the 22-1/2° skew installation, all round holes must be filled. For skews greater than 22-1/2°, only the diamond holes must be filled.



**Installation Sequence for Skews > 22½°:**

**Step 1:** Install acute side top and/or face header nails.

**Step 2:** Utilizing a piece of scrap fastened to the hanger on the obtuse side, bend the hanger to the desired angle.

**Step 3:** Bend the obtuse side of hanger back toward the header until the flange lies flat against the header, and install header top and/or face nails as noted below.

**Step 4:** Install carried truss and all required nails fasteners working from the bottom up.

Joist Material & Width	MiTek USP Stock No.	Ref. No.	Dimensions (in)		Min H <sub>eff</sub> <sup>2</sup> (in)	Mounting Condition <sup>3</sup>	Skew Angle (degrees)	Fastener Schedule <sup>4</sup>					DF/SP Allowable Loads (Lbs.)				S-P-F Allowable Loads (Lbs.)				Code Ref.			
			W	H				Carrying Member		Carried Member			Allowable Loads (Lbs.)				Allowable Loads (Lbs.)							
								Top Qty	Face Qty	Type	Qty	Type	100%	115%	125%	160%	Uplift <sup>1</sup>	100%	115%	125%		160%		
2x Trusses	MSHA29L/R	THASR/L29	1-5/8	10-3/4	7-1/4	face-max	22-1/2	--	12	10d	7	10d x 1-1/2	1500	1615	1615	975	1250	1275	1275	770				
							23 to 45	--	12	10d	4	10d x 1-1/2	1485	1485	1485	560	1250	1350	1350	435				
							46 to 75	--	12	10d	4	10d x 1-1/2	1500	1615	1615	720	1250	1315	1315	560				
						top-max	22-1/2	4	8	10d	7	10d x 1-1/2	1985	1985	1985	975	1510	1510	1510	745				
							23 to 45	4	8	10d	4	10d x 1-1/2	1705	1705	1705	560	1255	1255	1255	415				
							46 to 75	4	8	10d	4	10d x 1-1/2	1605	1605	1605	720	1605	1605	1605	560				
			top-min	22-1/2	4	4	10d	7	10d x 1-1/2	1350	1350	1350	--	1045	1045	1045	--							
				23 to 45	4	4	10d	4	10d x 1-1/2	1335	1335	1335	--	1060	1060	1060	--							
				46 to 75	4	4	10d	4	10d x 1-1/2	695	695	695	--	695	695	695	--							
			2-2x Trusses	MSHA29L/R-2	THASR/L29-2	3-1/8	10-3/4	7-1/4	face-max	22-1/2	--	12	10d	7	10d	1500	1615	1615	975	1215		1215	1215	735
										23 to 45	--	12	10d	4	10d	1485	1485	1485	560	1210		1260	1260	405
										46 to 75	--	12	10d	4	10d	1500	1615	1615	720	1250		1300	1300	555
top-max	22-1/2	4							8	10d	7	10d	1985	1985	1985	975	1495	1495	1495	735				
	23 to 45	4							8	10d	4	10d	1705	1705	1705	560	1275	1275	1275	420				
	46 to 75	4							8	10d	4	10d	1605	1605	1605	720	1565	1565	1565	535				
top-min	22-1/2	4				4	10d	7	10d	1350	1350	1350	--	1040	1040	1040	--							
	23 to 45	4				4	10d	4	10d	1335	1335	1335	--	1060	1060	1060	--							
	46 to 75	4				4	10d	4	10d	695	695	695	--	695	695	695	--							
4x Trusses	MSHA422L/R	THASR/L422				3-5/8	22	7-1/4	face-max	22-1/2	--	12	10d	7	10d	1500	1590	1590	960	1250	1250	1250	755	
										23 to 45	--	12	10d	4	10d	1485	1485	1485	550	1250	1335	1335	430	
										46 to 75	--	12	10d	4	10d	1500	1615	1615	705	1250	1300	1300	555	
			top-max	22-1/2	4				8	10d	7	10d	1955	1955	1955	960	1490	1490	1490	735				
				23 to 45	4				8	10d	4	10d	1680	1680	1680	550	1270	1270	1270	420				
				46 to 75	4				8	10d	4	10d	1605	1605	1605	705	1565	1565	1565	535				
			top-min	22-1/2	4	4	10d	7	10d	1330	1330	1330	--	1040	1040	1040	--							
				23 to 45	4	4	10d	4	10d	1335	1335	1335	--	1060	1060	1060	--							
				46 to 75	4	4	10d	4	10d	695	695	695	--	695	695	695	--							

1) Uplift loads have been increased 60% for wind or seismic loads; no further increase shall be permitted.  
 2) H<sub>eff</sub> is the minimum distance from the top of the hanger seat to the top of the carrying member.  
 3) For tabulated top-mount installation loads, the straps must be wrapped over the header a minimum of 2".  
 4) **NAILS:** 10d x 1-1/2" nails are 0.148" dia. x 1-1/2" long, 10d nails are 0.148" dia. x 3" long.

The SNP3 Skewed Nail Plate is designed for connecting square cut corner jack trusses at skews from 0° to 90°. An alternate installation for skews from 0° to 45° is depicted in Figure 2 below.

**Materials:** 16 gauge

**Finish:** G90 galvanizing

**Codes:** See page 12 for Code Reference Chart

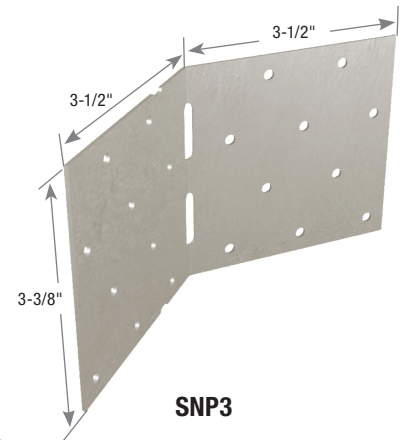
**Installation:**

• **Bend angle only once.**

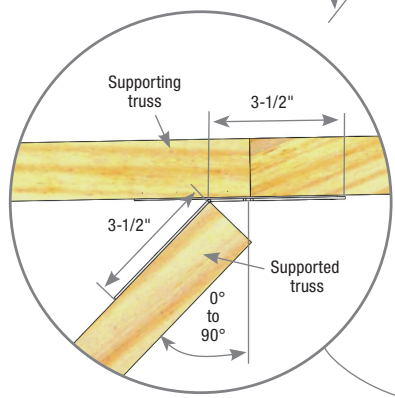
- 8d common (0.131" dia. x 2-1/2" long) nails may be substituted for 8d (0.131") x 1-1/2" nails with no reduction in load.

**Typical Installation (Figure 1):**

- Attach the SNP3 to the supported truss on the acute angle side so the SNP3 runs behind the end of the jack truss. Use all the specified fasteners listed in the table below. The fasteners should be installed nearest to bend line as possible then working to the opposite end of flange. Not all nail holes will be filled.
- Set the jack truss against the supporting truss and nail the exposed flange of the SNP3 into place. Use all the specified fasteners listed in the table below. The fasteners should be installed nearest to bend line as possible then working to the opposite end of flange. Not all nail holes will be filled.



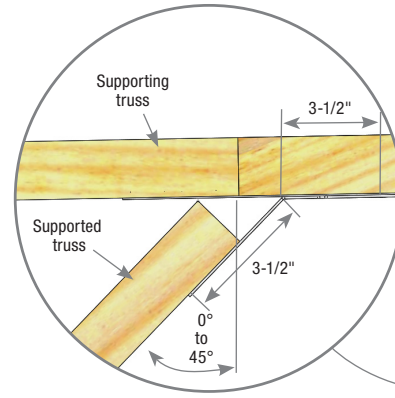
**SNP3**



**Typical SNP3 installation  
Figure 1**

**Alternate Installation (Figure 2):**

- Attach the SNP3 to the supported truss on the obtuse angle side so the SNP3 is on the front side of the jack truss. Use all the specified fasteners listed in the table below. The fasteners should be installed nearest to bend line as possible then working to the opposite end of flange but no closer than 5/8" from the end of the truss. Not all nail holes will be filled.
- Set the jack truss against the supporting truss and nail the exposed flange of the SNP3 into place. Use all the specified fasteners listed in the table below. The fasteners should be installed nearest to bend line as possible then working to the opposite end of flange. Not all nail holes will be filled.



**Alternate SNP3 installation  
Figure 2**

MiTek USP Stock No.	Ref. No.	Steel Gauge	Installation Type <sup>4</sup>	Fastener Schedule <sup>2</sup>				DF/SP		S-P-F		Code Ref.
				Supporting Member		Supported Member		Allowable Loads (Lbs.) <sup>1</sup>		Allowable Loads (Lbs.) <sup>1</sup>		
				Qty	Type	Qty	Type	Download	Upift	Download	Upift	
SNP3	TJC37	16	Figure 1	6	8d x 1-1/2	6	8d x 1-1/2	475	475	415	415	IBC, FL, LABC
			Figure 2	6	8d x 1-1/2	6	8d x 1-1/2	350	350	305	305	--

1) Allowable loads have been increased 60% for wind or seismic loads; no further increase shall be permitted.

2) Install specified fasteners from the bend line out from each end. Not all nail holes will be filled.

3) When installing SNP3's back to back, the table loads shall be multiplied by a reduction factor of 0.71.

4) Refer to drawings for installation type.

5) **NAILS:** 8d x 1-1/2 nails are 0.131" dia. x 1-1/2" long.

New products or updated product information are designated in blue font.

**HHC** – Designed to support hip/hip truss/rafter. Contact MiTek when using in multi-ply applications.

**HJHC** – Allows for hip/hip support and hip/jack/hip installations.

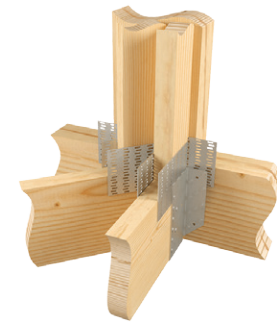
**HJC / HTHJ** – Used to simultaneously hang a combination of hips and jacks off girder trusses. These hangers fit both left-hand and right-hand applications. An open back design allows for retrofit installations.

**Materials:** HHC/HJC/HJHC – 12 gauge, HTHJ –18 gauge

**Finish:** G90 galvanizing

**Options:** See HJC Specialty Options Chart below

**Codes:** See page 12 for Code Reference Chart



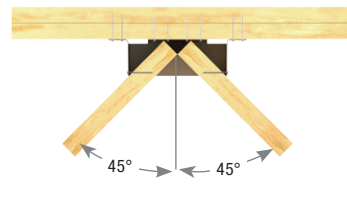
Typical HJC/HTHJ installation

**Installation:**

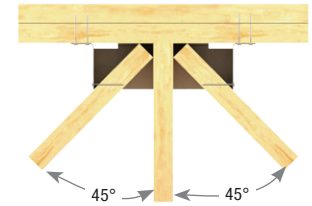
- Use all specified fasteners. See Product Notes, page 20.



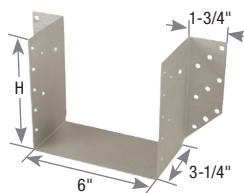
Typical HJC/HTHJ installation top view



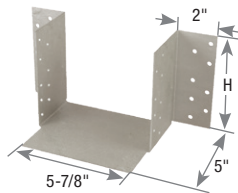
Typical HHC installation top view



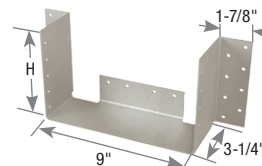
Typical HJHC installation top view



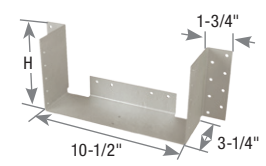
HJC



HTHJ



HHC



HJHC

Description	MiTek USP Stock No.	Ref. No.	Steel Gauge	H (in)	Fastener Schedule <sup>3</sup>					DF/SP Allowable Loads (Lbs.) <sup>2</sup>				S-P-F Allowable Loads (Lbs.) <sup>2</sup>				Code Ref.
					Supporting Member		Supported Member			Floor		Roof		Floor		Roof		
					Qty	Type	per Hip	per Jack	Type	100%	115%	125%	160%	100%	115%	125%	160%	
2 x 6 right / left	HJC26	LTHJA26, THJA26, THJU26	12	5-3/8	16	16d	5	7	10d	2750	3055	3265	2345	2420	2685	2750	1905	IBC, FL, LA
2 x 8 right / left	HJC28	--	12	7-1/8	20	16d	6	8	10d	3385	3385	3385	2345	2760	2760	2760	1910	
2 x 6 terminal	HHC26	LTHJA26, THJA26	12	5-7/16	20	16d	5	--	10d	3100	3505	3505	2130	2725	2800	2800	1870	--
2 x 8 terminal	HHC28	--	12	7-3/16	24	16d	6	--	10d	3505	3505	3505	2410	2805	2805	2805	1930	
2 x 6 terminal	HJHC26	--	12	5-7/16	20	16d	5	2	10d	3100	3505	3505	2410	2725	2815	2815	1935	
2 x 8 terminal	HJHC28	--	12	7-3/16	24	16d	6	2	10d	3505	3505	3505	2410	2820	2820	2820	1940	
2 x 6 terminal	HTHJ26-18	--	18	5	16	16d	7	5	16d	2295	2605	2695	1790	1985	2110	2110	1225	

1) Uplift loads have been increased 60% for wind or seismic loads; no further increase shall be permitted.

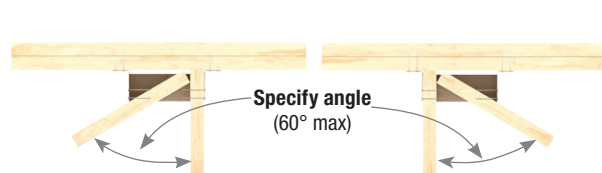
2) Loading published for total load of hip / jack connection.

3) **NAILS:** 10d nails are 0.148" dia. x 3" long, 16d nails are 0.162" dia. x 3-1/2" long.

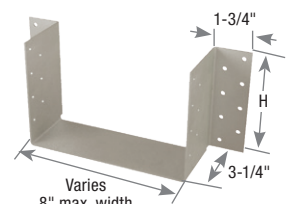
New products or updated product information are designated in **blue font**.

**HJC Specialty Options Chart**

Option	Hip Truss Skew
Range	30° to 60°
Allowable Loads	100% of table load
Ordering	Add SK, angle of hip required, to product number. Ex. HJC26_SK55



Typical HJC (skewed) installation with alternate skew angle top view



HJC (skewed)

# BN Breakfast Nook Hangers



Designed to carry four mono trusses in one connector, it reduces installation time and cost. Provides a tested, load rated connection. Standard configuration spacing: 22-1/2°, 45°, 45°, 45°, 22-1/2°. The design also includes field adjustable nailing tabs.

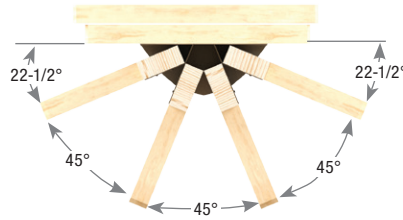
**Materials:** 14 gauge

**Finish:** Primer

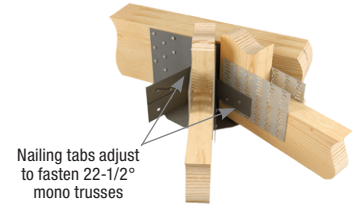
**Codes:** See page 12 for Code Reference Chart

**Installation:**

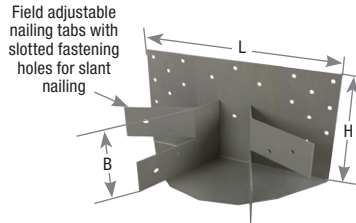
- Use all specified fasteners. See Product Notes, page 20.
- Allow a 2" setback for each mono truss.
- For pitched ceiling, design mono trusses with end-vertical upset. Upset equals tangent of the ceiling slope times 5.6".
- **Bend tab only once.**



**BN264**  
Standard configuration  
(top view)



**Typical BN264**  
installation



**BN264**

MiTek USP Stock No.	Ref. No.	Steel Gauge	Dimensions (in)			Fastener Schedule <sup>4</sup>				DF/SP Allowable Loads (Lbs.) <sup>3</sup>				Code Ref.
			L	H	B	Carrying Member		Allowable Loads (Lbs.) <sup>3</sup>						
						Qty	Type	100%	115%	125%	160%			
BN264	THJM2-4-SDS3	14	10	5-3/8	3-1/4	20	10d	2	10d x 1-1/2	2640	3035	3145	585	IBC,
BN284	--	14	10	7-1/8	3-1/4	20	10d	2	10d x 1-1/2	2640	3035	3145	585	FL, LA

1) Uplift loads have been increased 60% for wind or seismic loads; no further increase shall be permitted.  
 2) Maximum uplift per mono truss is 175-lb at 160% for DF/SP and 150-lb at 160% for S-P-F.  
 3) Loading published is for total load of connection.  
 4) **NAILS:** 10d x 1-1/2 nails are 0.148" dia. x 1-1/2" long, 10d nails are 0.148" dia. x 3" long.

## LDSC / DSC Drag Strut Connectors

Transfers lateral loads from girder truss into bearing walls.

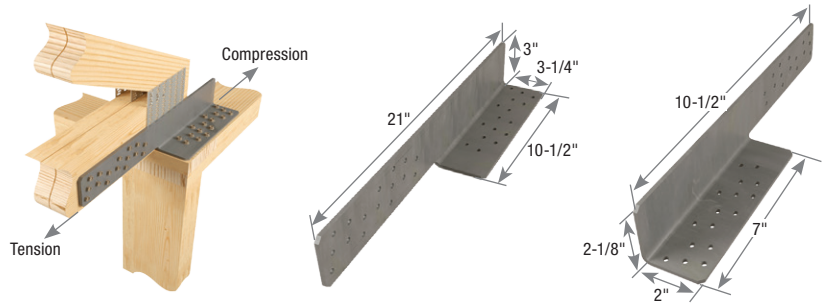
**Materials:** See chart

**Finish:** Primer

**Codes:** See page 12 for Code Reference Chart

**Installation:**

- Use all specified fasteners. See Product Notes, page 20.
- WS3 Wood Screw, 1/4" dia. x 3" long, are supplied with DSC4 connector.



**Typical DSC4R installation**    **DSC4R right shown**    **LDSC4L left shown**

MiTek USP Stock No.	Ref. No.	Steel Gauge	Fastener Schedule <sup>2,3</sup>				DF/SP Allowable Loads (Lbs.) <sup>1</sup>		S-P-F Allowable Loads (Lbs.) <sup>1</sup>		Code Ref.
			Truss		Top Plate		Compression	Tension	Compression	Tension	
			Qty	Type	Qty	Type	160%	160%	160%	160%	
LDSC4L/R	--	14	9	10d x 1-1/2	9	10d x 1-1/2	1500	1505	1260	1265	IBC,
DSC4L/R	DSC5R/L-SDS3	3	16	WS3	16	WS3	4965	4945	4270	4250	FL, LA

1) Allowable loads have been increased 60% for wind or seismic loads; no further increase shall be permitted.  
 2) WS3 wood screws are 1/4" dia. x 3" long and are included with DSC4 connector.  
 3) **NAILS:** 10d x 1-1/2 nails are 0.148" dia. x 1-1/2" long.

The GTWS series girder-to-girder hangers feature high uplift capacities along with high gravity load ratings.

**Materials:** 10 gauge

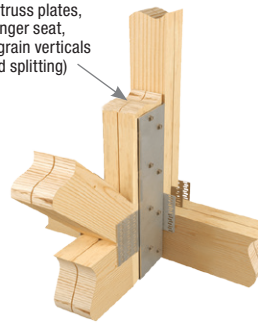
**Finish:** G90 galvanizing

**Codes:** See page 12 for Code Reference Chart

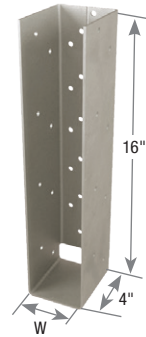
**Installation:**

- Use all specified fasteners. See Product Notes, page 20.
- WS Wood Screws are included with hangers where specified.
- **GTWS2T** shall be installed to a minimum 2x4 vertical member of a girder truss with no restriction on the size of the bottom chord.
- **GTWS3T** shall be installed to a minimum 2x6 vertical member of a girder truss with no restriction on the size of the bottom chord.
- **GTWS4T** shall be installed to a minimum 2x8 vertical member of a girder truss with no restriction on the size of the bottom chord.

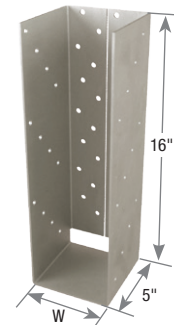
Min. 2x6 vertical  
(Min. 3" height truss plates,  
flush with hanger seat,  
required on end grain verticals  
to resist wood splitting)



**Typical GTWS installation**



**GTWS2T**



**GTWS3T**

MiTek USP Stock No.	Ref. No.	Steel Gauge	Dimensions (in)			Fastener Schedule <sup>2,3,4</sup>				No. of Plies	DF/SP Allowable Loads (Lbs.)				Code Ref.
						Supporting Truss		Supported Truss			Uplift <sup>1</sup>				
			W	H	D	Qty	Wood Screws	Qty	Wood Screws		100%	115%	125%	160%	
GTWS2T	--	10	3-1/4	16	4	22	WS3	16	WS3	2	8720	10030	10900	9770	FL
GTWS3T	--	10	4-7/8	16	5	28	WS3	24	WS3	3	11100	12470	12470	12490	
GTWS4T	--	10	6-1/2	16	5	28	WS3	24	WS3	4	11100	12470	12470	12490	

1) Uplift loads have been increased 60% for wind or seismic loads; no further increase shall be permitted.  
 2) WS3 wood screws require a minimum 3" wood penetration.  
 3) WS3 wood screws are 1/4" dia. x 3" long and are included with the GTWS hangers.  
 4) WS3 wood screws may be installed in both vertical and horizontal members.

The GTQ / GTQM hangers connect to multi-ply girder truss with MiTek's WS Wood Screws offering high load capacities. Design features minimum and maximum fastening installation options to accommodate various sizes of vertical web. GTQM's are designed for LVL sizes, for example GTQM218.

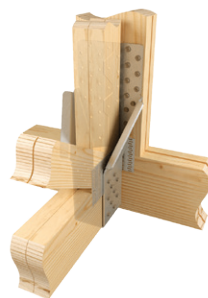
**Materials:** 7 gauge

**Finish:** G90 galvanizing

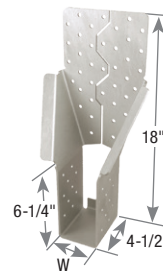
**Codes:** See page 12 for Code Reference Chart

**Installation:**

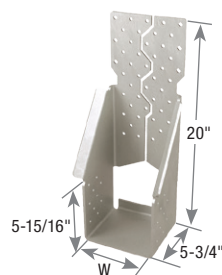
- Use all WS wood screws as specified.
- Install hanger centered on vertical web.
- GTQ's are designed to be installed on various sizes of vertical web. Maintain a minimum 5/8" fastener edge distance as per the National Design Specification where truss connector plates are not present.
- Install WS wood screws in all fastener holes including diamond holes for maximum values.
- Refer to Backer Block installation on page 257 if the length of the screws going into the supporting truss are longer than the thickness of the plies.



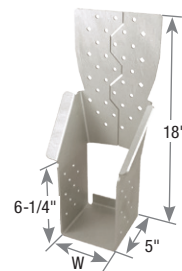
**Typical GTQ218 installation**  
(GTQM218 similar)



**GTQ218**  
(GTQM218 similar)



**GTQ420**  
(GTQM420 similar)



**GTQ318**  
(GTQM318 similar)

Plated Truss

MiTek USP Stock No.	Ref. No.	W (in)	Install Type	Min Vert Web Size	Fastener Schedule <sup>1,3</sup>					DF/SP Allowable Loads (Lbs.)					S-P-F Allowable Loads (Lbs.)					Code Ref.	
					Supporting Truss <sup>4,5</sup>			Supported Truss		Allowable Loads (Lbs.)					Allowable Loads (Lbs.)						
					Qty	Type <sup>5</sup>	Min. No. of Plies	Qty <sup>6</sup>	Type	No. of Plies	Floor	Roof	Wind <sup>8</sup>	Uplift <sup>2</sup>	Floor	Roof	Wind <sup>8</sup>	Uplift <sup>2</sup>			
GTQ218	THGQ2-SDS3, THGQH2-SDS3	3-1/4	Min	2x6	18	WS3	2	20	WS3	2	6965	7900	7900	7900	4595	6225	6605	6605	6605	3845	--
			Max	2x8	30						11610	13160	13160	13160	4595	10375	11005	11005	11005	3845	
GTQM218 <sup>7</sup>	--	3-5/8	Min	2x6	18						6965	7900	7900	7900	4595	6225	6605	6605	6605	3845	
			Max	2x8	30						11610	13160	13160	13160	4595	10375	11005	11005	11005	3845	
GTQ318	THGQ3-SDS4.5, THGQH3-SDS4.5	4-7/8	Min	2x6	25	WS45	2	20	WS45	3	11480	11480	11480	11480	4595	10240	10240	10240	10240	3810	
			Max	2x8	33						14665	14665	14665	14665	4760	14500	14500	14500	14500	3945	
GTQM318 <sup>7</sup>	--	5-1/2	Min	2x6	25						11480	11480	11480	11480	4595	10240	10240	10240	10240	3810	
			Max	2x8	33						14665	14665	14665	14665	4760	14500	14500	14500	14500	3945	
GTQ420	THGQH4-SDS6	6-1/2	Min	2x8	41	WS6	3	20	WS6	4	14435	14435	14435	14435	4690	14435	14435	14435	14435	3745	
			Max	2x10	47						17600	17600	17600	17600	4690	15795	15795	15795	15795	3745	
GTQM420 <sup>7</sup>	--	7-1/4	Min	2x8	41						14435	14435	14435	14435	4690	14435	14435	14435	14435	3745	
			Max	2x10	47						17600	17600	17600	17600	4690	15795	15795	15795	15795	3745	

1) WS3 Wood Screws are 1/4" x 3" long, WS45 Wood Screws are 1/4" x 4-1/2" long, WS6 Wood Screws are 1/4" x 6" long. Screws are included with GTQ and GTQM hangers.

2) Uplift loads have been increased 60% for wind or seismic loads; no further increase shall be permitted.

3) WS Wood Screws may be installed through metal truss connector plates as approved by truss designer per ANSI/TPI 1-2007 Section 7.5.3.4 and 8.9.2. Pre-drilling required through the plate using a maximum of 5/32" bit.

4) Truss plies of the supporting member must be fastened together to transfer the load (through all truss plies) that is not transferred by the hanger screws; fastening schedule is to be specified by the truss designer.

5) If the length of the screws going into the supporting truss are longer than the thickness of the plies, refer to the backer block installation on page 259.

6) Wood screws specified for supported member must ALL be installed into the supported member while maintaining a minimum 5/8" edge distance where truss connector plates are not present.

7) Supported members on GTQM hangers shall have Specific Gravity of not less than 0.46.

8) Wind (160%) is a download value.

The GT primarily hangs girder trusses off other girder trusses, although a wide variety of other heavy-duty installations apply.

**Materials:** Back Plate – 3 gauge; Strap – 7 gauge

**Finish:** Primer

**Options:** All models available in LVL sizes, use M in place of T, as in GT2M4B.

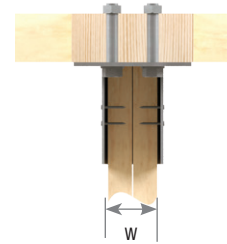
**Codes:** See page 12 for Code Reference Chart

**Installation:**

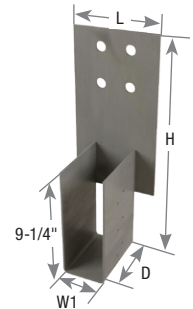
- Use all specified fasteners. See Product Notes, page 20.
- Minimum heel height is 9-1/4" for GT hangers.



**Typical GT2T4B installation**



**GT top view**



**GT2T4B**

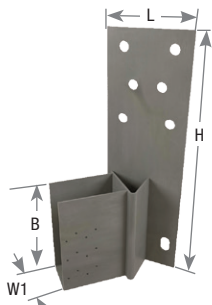
Supported Member	MiTek USP Stock No.	Ref. No.	Dimensions (in)				Fastener Schedule <sup>1,2,3</sup>				No of Plies	DF Allowable Loads (Lbs.)			S-P-F Allowable Loads (Lbs.)			Code Ref.
			W1	L	H	D	Supporting Truss		Supported Truss			Supporting Member			Supporting Member			
							Qty	Bolt Dia (in)	Qty	Type		100%	115%	Uplift 160%	100%	115%	Uplift 160%	
2-ply	GT2T2B	--	3-7/16	6	19	4-1/2	2	3/4	12	16d	2	2950	3390	2705	2515	2895	2270	
										≥ 3	3340	3840			3085	3475		
	GT2T2BH	--	3-7/16	6	22-1/4	4-1/2	2	1	12	16d	2	3920	4510	2705	3330	3830	2270	
										≥ 3	5550	5550			4660	4660		
	GT2T3B	--	3-7/16	6	22	4-1/2	3	3/4	12	16d	2	4370	5025	2705	3710	4265	2270	
										≥ 3	4985	5730			4590	5275		
	GT2T4B	THGB2	3-7/16	7	19	5-1/2	4	3/4	12	16d	2	5905	6790	2705	5040	5795	2270	
									≥ 3	6680	7680		5500		5795			
GT2T6B	--	3-7/16	7-1/4	22	6	6	3/4	12	16d	2	8860	10190	2705	7560	8695	2270		
									≥ 3	10020	11520			9260	9940			
GT2T6BH	--	3-7/16	7-1/4	26-1/4	6	6	1	12	16d	2	11795	13565	2705	9640	9940	2270		
									≥ 3	13580	13925			9640	9940			
GT2T8B	THGBH2	3-7/16	7-1/4	25	6	8	3/4	12	16d	2	11815	13585	2705	9640	9940	2270		
									≥ 3	13355	13925			9640	9940			
3-ply	GT3T3B	--	5-1/8	6	22	4-1/2	3	3/4	12	16d	2	4370	5025	2705	3710	4265	2270	
										≥ 3	4985	5730			4590	5275		
	GT3T3BH	--	5-1/8	6	26-1/4	4-1/2	3	1	12	16d	2	5740	6605	2705	4830	5555	2270	
										≥ 3	8490	9465			7160	7950		
	GT3T4B	THGB3	5-1/8	7	19	5-1/2	4	3/4	12	16d	2	5905	6790	2705	5040	5795	2270	
										≥ 3	6680	7680			6175	7100		
	GT3T4BH	--	5-1/8	7	22-1/4	5-1/2	4	1	12	16d	2	7865	9045	2705	6685	7690	2270	
										≥ 3	11435	13150			9720	11180		
	GT3T6B	--	5-1/8	7-1/4	22	6	6	3/4	12	16d	2	8860	10190	2705	7560	8695	2270	
									≥ 3	10020	11520		9260		10650			
GT3T6BH	--	5-1/8	7-1/4	26-1/4	6	6	1	12	16d	2	11795	13565	2705	10030	11535	2270		
									≥ 3	14860	14860			13075	13075			
GT3T8B	THGBH3	5-1/8	7-1/4	25	6	8	3/4	12	16d	2	11815	13585	2705	10080	11590	2270		
									≥ 3	13355	15360			12350	13090			
GT3T8BH	--	5-1/8	7-1/4	30-1/4	6	8	1	12	16d	2	15725	18085	2705	13370	13765	2270		
									≥ 3	19205	19465			13465	13765			

IBC, FL, LA

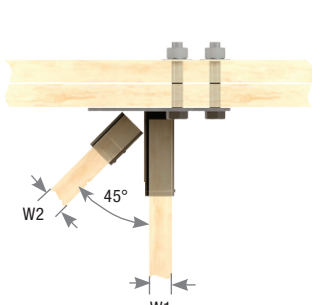
Plated Truss

Copyright © 2019 MiTek Industries, Inc. All Rights Reserved

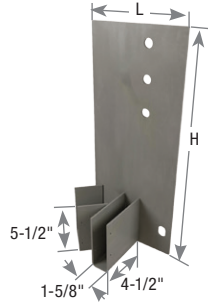
1) Bolts shall conform to ASTM A 307 Grade A or better.  
 2) GT series require 2 x 6 vertical member for 2-, 3-, and 4-bolt hangers and 2 x 8 for 6 and 8-bolt hangers.  
 3) **NAILS:** 16d nails are 0.162" dia. x 3-1/2" long.



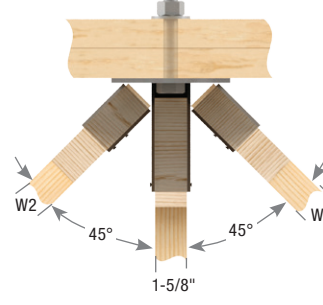
GT skewed



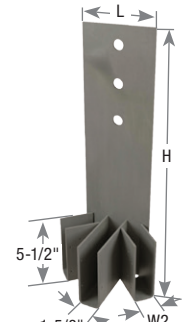
GTS  
top view (left shown)



GTS1T2H3BSKL  
(left shown)



GTD  
top view



GTD1T1H3B

Plated Truss

Supported Member	MiTek USP Stock No. <sup>4,5</sup>	Ref. No.	Dimensions (in)					Fastener Schedule <sup>2,3,6</sup>						No. of Plies	DF Allowable Loads (Lbs.)			S-P-F Allowable Loads (Lbs.)			Code Ref.	
			W1	W2	L	H	B	Supporting Truss		Supported Truss		Supported Hip			Supporting Member			Supporting Member				
								Qty	Bolt Dia.	Qty	Type	Qty	Type		100%	115%	Uplift 160%	100%	115%	Uplift 160%		
																				2		≥ 3
4-ply	GT4T4B	--	6-1/2	--	7-1/2	19	5-1/2	4	3/4	12	16d	--	--	2	5905	6790	2705	5040	5795	2270	IBC, FL, LA	
	GT4T4BH	--	6-1/2	--	7-1/2	22-1/4	5-1/2	4	1	12	16d	--	--	2	7860	9040	2705	6685	7685	2270		
	GT4T6B	--	6-1/2	--	7-1/2	22	6	6	3/4	12	16d	--	--	2	8860	10185	2705	7560	8690	2270		
	GT4T6BH	--	6-1/2	--	7-1/2	26-1/4	6	6	1	12	16d	--	--	2	11790	13560	2705	10025	11530	2270		
	GT4T8B	THGBH4	6-1/2	--	7-1/2	25	6	8	3/4	12	16d	--	--	2	11810	13580	2705	10080	11590	2270		
5-ply	GT5T8BH	--	8-1/8	--	9-1/4	30-1/4	6	8	1	12	16d	--	--	2	15720	18080	2705	13365	15370	2270		
														≥ 3	19465	19465		16350	16350			
2-ply skewed 45°	GT2T2BSKL/R	--	3-7/16	--	6	19	9-1/4	3	3/4	12	16d	--	--	2	2920	3355	2000	2555	2715	1600		
	GT2T4BSKL/R	--	3-7/16	--	7-1/4	19	9-1/4	5	3/4	12	16d	--	--	2	5835	6710	2000	5110	5875	1600		
1-ply hip & jack	GTS1T1H3BSKL/R	--	1-5/8	1-5/8	9-1/4	22	5-1/2	4	3/4	4	10d x 1-1/2	4	10d x 1-1/2	2	4215	4850	--	3690	4005	--		
	GTS1T1H4BSKL/R	--	1-5/8	1-5/8	9-1/4	19	5-1/2	5	3/4	4	10d x 1-1/2	4	10d x 1-1/2	2	5830	6705	--	5105	5760	--		
2-ply hip & 1-ply jack	GTS1T2H3BSKL/R	--	1-5/8	3-4/9	9-1/4	22	5-1/2	4	3/4	4	10d x 1-1/2	4	10d x 1-1/2	2	4215	4850	--	3690	3985	--		
1-ply terminal hip	GTD1T1H2B	--	1-5/8	1-5/8	6	19	5-1/2	2	3/4	4	10d x 1-1/2	4	10d x 1-1/2	2	2920	3360	--	2555	2940	--		
														≥ 3	3295	3790		3115	3295			
1-ply terminal hip	GTD1T1H3B	--	1-5/8	1-5/8	6	22	5-1/2	3	3/4	4	10d x 1-1/2	4	10d x 1-1/2	2	4240	4875	--	3710	3990	--		
														≥ 3	4785	5500		4520	4550			
2-ply terminal hip	GTD1T2H3B	--	1-5/8	3-7/16	8	22	5-1/2	3	3/4	4	10d x 1-1/2	4	10d x 1-1/2	2	4225	4855	--	3695	3975	--		
														≥ 3	4765	5480		4500	4535			

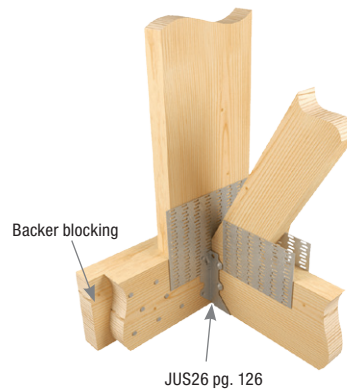
1) The listed loads for GTS and GTD is the total of hip and jack connection.  
 2) Bolts shall conform to ASTM A 307 or better.  
 3) GT Series require 2 x 6 vertical member for 2, 3, and 4 bolt hangers and 2 x 8 for 6 and 8 bolt hangers.  
 4) All side pocket applications assume 45° angle.  
 5) Must specify right or left for all GTS and GT skewed.  
 6) **NAILS:** 10d x 1-1/2 nails are 0.148" dia. x 1-1/2" long, 16d nails are 0.162" dia. x 3-1/2" long.



### Backer block installation

Wood blocking used to achieve full design load value of a face mount hanger attached to a carrying member. **Blocking to be designed by truss designer or engineer of record.**

- Wood blocking should be of similar size/grade as the truss member to which it is attached. The blocking should be designed to act as one unit with truss members.
- Truss designer shall approve blocking size/grade, fasteners required, and application.
- All fasteners used to attach wood blocking should be independent of the fasteners in the truss hanger.

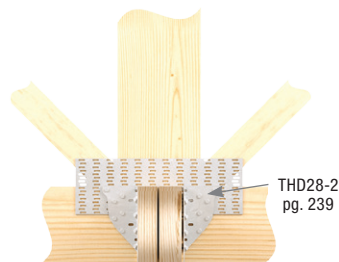


### Panel point installation

Connection with face mount hanger attaching to a truss panel point.

Hanger nails that do not penetrate wood in panel point provide no load resistance.

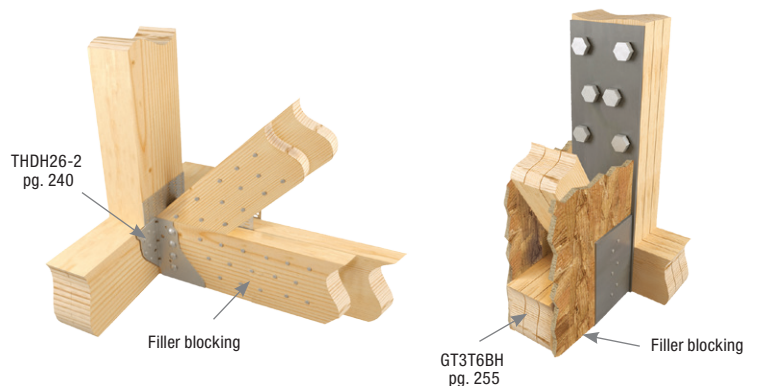
Reduce load according to the code.



### Filler block installation

Wood filler blocking used for supported member width less than hanger width.

**Blocking and blocking fasteners/quantity to be designed by truss designer or engineer of record.**



# Truss Brace & Spacer (Stabilizer™)



The Stabilizer™ Truss Brace & Spacer provides temporary construction bracing in the roof and ceiling planes, as well as permanent lateral bracing for webs as specified by your truss engineering.

The Stabilizer™ is easily installed by embedding the patented MII 20 teeth on the top flange straight into the edge of the truss member to be braced with a framing hammer. The side tabs are then secured by driving the teeth into the face of the truss member being braced.

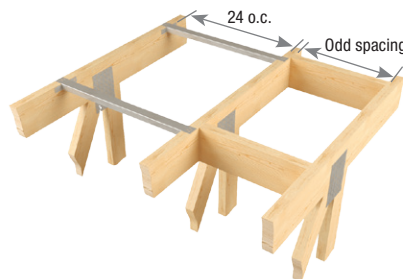
**Materials:** 20 gauge

**Finish:** G60 galvanizing

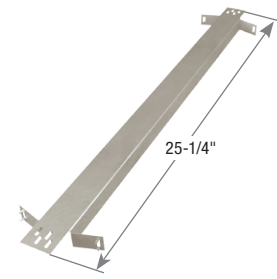
**Codes:** See page 12 for Code Reference Chart

**Installation:**

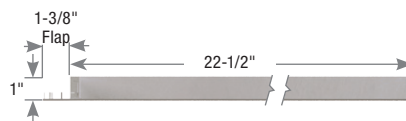
- Use 31-16 for standard 16" o.c. spacing and 31-24 for standard 24" o.c. spacing. For odd spacing, cut and insert a solid block between the trusses.
- Typically, The Stabilizer™ is installed at 6'– 8' centers along the roof plane and 10'– 15' along the ceiling plane. (Refer to engineering specifications BCSI 1-03, published by The Truss Plate Institute for specific bracing requirements.)
- The Stabilizer™ must be supplemented with diagonal bracing in the roof and ceiling planes and cross bracing in the web plane at required intervals.
- Web forces are not to exceed 8000 lbs.
- The Stabilizer™ is properly installed when the top flap and side tabs are flush with the member being braced.



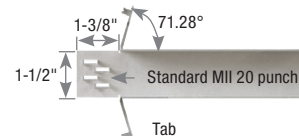
Temporary construction bracing installation



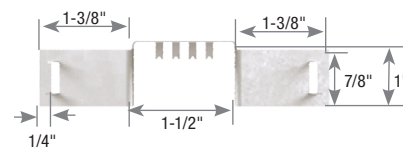
31-24 Stabilizer™



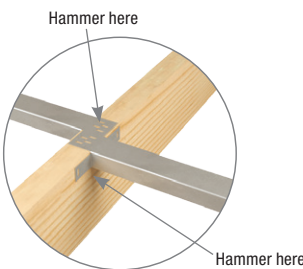
Side view



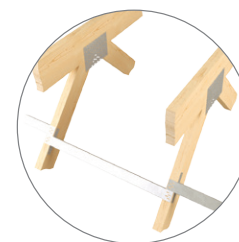
Top view



End view



Chord attachment detail



Web bracing installation

**Important:** The erection contractor is responsible for determining and installing the temporary bracing for the structure, including the trusses. It is most important for the installer to provide adequate means for bracing the first truss installed. The performance of the entire bracing system depends on the adequacy of the ground bracing or other means of bracing the first group of trusses installed. The building designer is responsible for the permanent bracing design of the overall structure including the truss. This includes the design of required supplemental diagonal and cross bracing.

MiTek USP Stock No.	Ref. No.	Steel Gauge	O.C. Spacing (in)	Allowable Axial Loads (Lbs.)			Code Ref.
				Tension	Tension with Fastener	Compression	
31-16	TSBR2-16	20	16	105	155	420	IBC
31-24	TSBR2-24	20	24	105	155	420	

- 1) 1 pound = 4.448N.
- 2) Fastener shall be (1) 8d or 10d common wire nail inserted through nail slot.
- 3) **NAILS:** 8d nails are 0.131" dia. x 2-1/2" long, 10d nails are 0.148" dia. x 3" long.

Truss spacers give framers fast and accurate spacing for trusses, rafters, or floor joists. The TS and TSX eliminate the need to mark layouts on bearing plates, improve installation speed, and help eliminate spacing errors. These spacers are light weight and compact.

**Materials:** See chart

**Finish:** G90 galvanizing

**Codes:** See page 12 for Code Reference Chart

**Installation:**

- Use (1) 8d nail per end to fasten units to trusses, rafters, or floor joists.

**Important:** These units provide spacing guides only. Do not rely on the TS or TSX for bracing.

Joist Width (in)	MiTek USP Stock No. <sup>1</sup>	Ref. No.	Steel Gauge	O. C. Spacing	Overall Length	Sections Per Piece	Fastener Schedule		Code Ref.
							Qty	Type <sup>2</sup>	
1-1/2	TS	--	20	24	2-ft 1-1/2"	1	2	8d	--
1-1/2	TSX16	TSF2-16	22	16	8-ft	6	2	8d	
1-1/2	TSX24	TSF2-24	22	24	10-ft	5	2	8d	

1) TSX spacers are shipped folded.

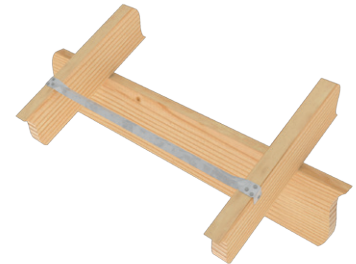
2) **NAILS:** 8d nails are 0.131" dia. x 2-1/2" long.



Typical TSX installation



TSX multi-unit spacer



Typical TS installation



TS single-unit spacer

Use the SBP instead of extra truss plies or nail-on scabs to distribute concentrated truss reactions and avoid top plate crushing. The two-piece design accommodates any number of girder plies. A wraparound design gives superior uplift resistance, and reinforcement ribs effectively distribute bearing loads. Works with both single and double 2x4 or 2x6 top plates.

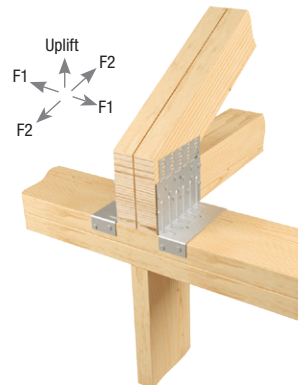
**Materials:** 16 gauge

**Finish:** G90 galvanizing

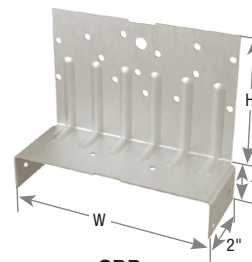
**Codes:** See page 12 for Code Reference Chart

**Installation:**

- Use all specified fasteners. See Product Notes, page 20.
- **The SBP shall be installed in pairs.**



Typical SBP installation



SBP

Plated Truss

No. of Truss Plies	Wood Species	F <sub>c</sub> (psi)	Allowable Loads (Lbs.) <sup>1,2,3</sup>								
			SBP's Alone			SBP + Truss Bearing <sup>4</sup>					
			100%	115%	125%	100%	EBL	115%	EBL	125%	EBL
<b>SBP4 on 2 x 4 Top Plate (3-1/2" wide)</b>											
1-Ply	DF	625	2500	2805	2955	5780	6.17	6085	6.49	6235	6.65
	SP	565	2745	2955	2955	5710	6.74	5920	6.99	5920	6.99
	S-P-F	425	2200	2365	2365	4430	6.95	4595	7.21	4595	7.21
	Hem Fir	405	2245	2445	2445	4370	7.19	4570	7.52	4570	7.52
2-Ply	DF	625	2500	2805	2955	9065	4.83	9370	5.00	9520	5.08
	SP	565	2745	2955	2955	8680	5.12	8890	5.24	8890	5.24
	S-P-F	425	2200	2365	2365	6665	5.23	6830	5.36	6830	5.36
	Hem Fir	405	2245	2445	2445	6500	5.35	6700	5.51	6700	5.51
3-Ply	DF	625	2500	2805	2955	12345	4.39	12650	4.50	12800	4.55
	SP	565	2745	2955	2955	11645	4.58	11855	4.66	11855	4.66
	S-P-F	425	2200	2365	2365	8895	4.65	9060	4.74	9060	4.74
	Hem Fir	405	2245	2445	2445	8625	4.73	8825	4.84	8825	4.84
4-Ply	DF	625	2500	2805	2955	15625	4.17	15930	4.25	16080	4.29
	SP	565	2745	2955	2955	14610	4.31	14820	4.37	14820	4.37
	S-P-F	425	2200	2365	2365	11125	4.36	11290	4.43	11290	4.43
	Hem Fir	405	2245	2445	2445	10750	4.42	10950	4.51	10950	4.51
<b>SBP6 on 2 x 6 Top Plate (5-1/2" wide)</b>											
1-Ply	DF	625	3500	3930	4235	8655	9.23	9085	9.69	9390	10.02
	SP	565	3845	4295	4295	8505	10.04	8955	10.57	8955	10.57
	S-P-F	425	3080	3415	3415	6585	10.33	6920	10.85	6920	10.85
	Hem Fir	405	3140	3525	3535	6480	10.67	6865	11.30	6875	11.32
2-Ply	DF	625	3500	3930	4235	13815	7.37	14245	7.60	14550	7.76
	SP	565	3845	4295	4295	13170	7.77	13620	8.04	13620	8.04
	S-P-F	425	3080	3415	3415	10095	7.92	10430	8.18	10430	8.18
	Hem Fir	405	3140	3525	3535	9825	8.09	10210	8.40	10220	8.41
3-Ply	DF	625	3500	3930	4235	18970	6.74	19400	6.90	19705	7.01
	SP	565	3845	4295	4295	17830	7.01	18280	7.19	18280	7.19
	S-P-F	425	3080	3415	3415	13600	7.11	13935	7.29	13935	7.29
	Hem Fir	405	3140	3525	3535	13165	7.22	13550	7.43	13560	7.44
4-Ply	DF	625	3500	3930	4235	24125	6.43	24555	6.55	24860	6.63
	SP	565	3845	4295	4295	22490	6.63	22940	6.77	22940	6.77
	S-P-F	425	3080	3415	3415	17105	6.71	17440	6.84	17440	6.84
	Hem Fir	405	3140	3525	3535	16505	6.79	16890	6.95	16900	6.95

- 1) Allowable loads are for a pair of SBP devices. SBP's shall be installed in pairs.
- 2) Multiple ply trusses shall be fastened together to act as a single unit.
- 3) EBL denotes effective bearing length in inches and includes the actual bearing length plus the contribution of the SBP device.
- 4) Assumes full seating of truss on top plate.

MiTek USP Stock No.	Ref. No.	Steel Gauge	Dimensions (in)		Joist Thickness (in)	Fastener Schedule <sup>1,5</sup>					DF/SP Allowable Loads (Lbs.) <sup>2,3</sup>			S-P-F Allowable Loads (Lbs.) <sup>2,3</sup>			Code Ref.
			W	H		Plate		Truss			Uplift <sup>4</sup> 160%	F1 160%	F2 160%	Uplift <sup>4</sup> 160%	F1 160%	F2 160%	
						Top Qty	Sides Qty	Type	Qty	Type							
SBP4	TBE4	16	3-1/2	3-1/4	2-7/8 or less 3 or more	4	8	10d	20	10d x 1-1/2	1255	1530	1625	850	1195	1335	IBC, FL, LA
SBP6	TBE6	16	5-1/2	3-1/4	2-7/8 or less 3 or more	4	8	10d	28	10d x 1-1/2	1255	1530	1625	850	1195	1335	

- 1) Fastener Schedule is for a pair of SBP devices.
- 2) Allowable loads are for a pair of SBP devices. SBP's shall be installed in pairs.
- 3) Multiple ply trusses shall be fastened together to act as a single unit.
- 4) Uplift loads have been increased 60% for wind or seismic loads; no further increase shall be permitted.
- 5) **NAILS:** 10d x 1-1/2 nails are 0.148" dia. x 1-1/2" long, 10d nails are 0.148" dia. x 3" long.

FTC clips slide easily onto the top or bottom chord and provides a guide to help position and support the second truss during assembly.

FTCF clips easily install after the trusses are installed.

**Materials:** 18 gauge

**Finish:** G90 galvanizing

**Codes:** See page 12 for Code Reference Chart

**Patents:** U.S. Patent No. 5,653,079

**Installation:**

- Use all specified fasteners. See Product Notes, page 20.
- The truss designer must determine the number of clips and spacing between units according to concentrated load conditions and uniform loading requirements.

**Concentrated Load Spacing Tips:**

Divide half of the concentrated load by the clip capacity to find the number of clips required.

**Example:**

Concentrated (point) load = 3000 lbs, FTC1 capacity (DF/SP) = 865 lbs

$$\frac{1/2 (3000 \text{ lbs})}{865 \text{ lbs}} = 1.73 = 2 \text{ clips}$$

Place 2 clips near concentrated load.

**Uniform Load Spacing Tips:**

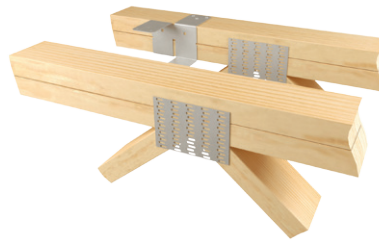
Divide the clip capacity by half the required load per lineal foot.

**Example:**

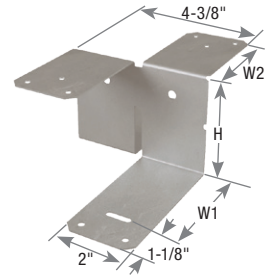
Uniform (distributed) load = 500 lbs/ft, FTC1 capacity (DF/SP) = 865 lbs

$$\frac{1/2 (500 \text{ lbs})}{865 \text{ lbs}} = 3.46' \text{ spacing}$$

Space clips at 3'4" along length of truss.



Typical FTC installation



FTC



Typical FTC 2-ply metal web truss installation



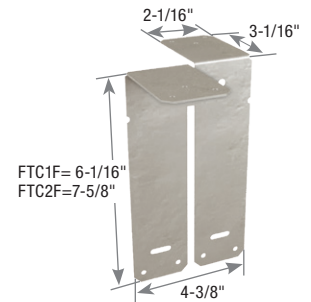
Step 1



Step 2

Typical FTC2F retrofit installation

Truss Size	MiTek USP Stock No.	Ref. No.	Steel Gauge	Dimensions (in)			Fastener Schedule <sup>3</sup>		DF/SP Maximum Transfer Loads <sup>1,2</sup>	S-P-F Maximum Transfer Loads <sup>1,2</sup>	Code Ref.
				W1	W2	H	Qty	Type			
3 x 2	FTC32	--	18	2-1/16	2-1/2	1-1/2	10	10d x 1-1/2	680	590	IBC, FL, LA
4 x 2	FTC1	--	18	3-1/2	3-1/16	1-1/2	10	10d	865	750	
	FTC1F	--	18	3-1/16	--	4-3/8	10	10d	865	750	
(2) 4 x 2	FTC2	--	18	3-1/2	3-1/16	3	10	10d	865	750	
	FTC2F	--	18	3-1/16	--	4-3/8	10	10d	865	750	



FTCF

1) Transfer loads are for 100% floor load, and shall not be increased for short term load duration.  
 2) Truss designer shall determine the number of clips for concentrated loads and the spacing for uniform loads.  
 3) **NAILS:** 10d x 1-1/2 nails are 0.148" dia. x 1-1/2" long, 10d nails are 0.148" dia. x 3" long.

VTT Valley Truss Tie is designed to transfer loads from a valley truss into the supporting structure below. It also resists the sliding forces from downward loads when the valley truss is set upon a sloped lower roof. The ability to resist the sliding force eliminates the need for support wedges under the valley truss bottom chord or special order valley roof trusses with a bevel-cut bottom chord.

- Double-dimple nail holes assure the nails are driven in at the correct angle into the supporting member every time.
- Flat design requires no field bending to match the supporting roof pitch.
- 2-Ply steel with stiffening ribs provides a high resistance to sliding forces from downward loads.
- Prong teeth help hold the VTT in place while nailing.
- Accommodates supporting roof pitches from 0/12 to 12/12.
- Pitch guide embossments allow attachment to valley truss on ground.

**Materials:** 18 gauge

**Finish:** G90 galvanizing

**Codes:** See page 12 for Code Reference Chart

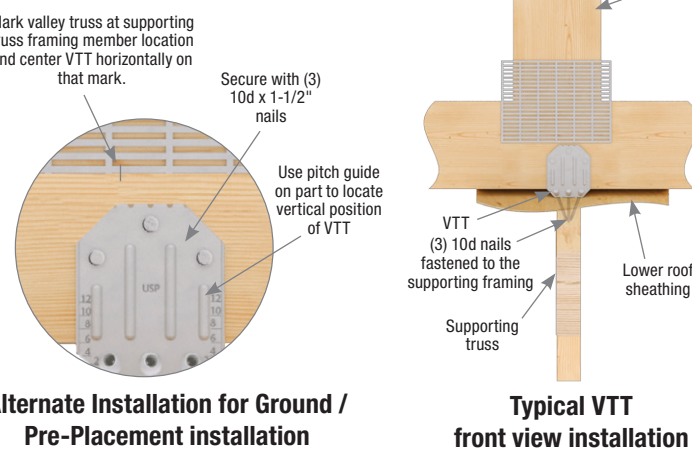
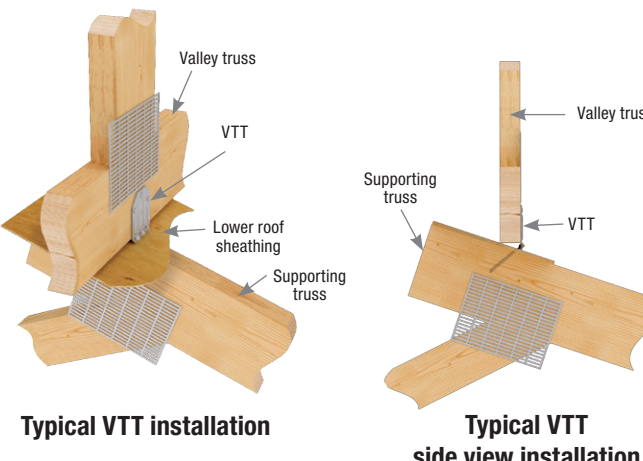
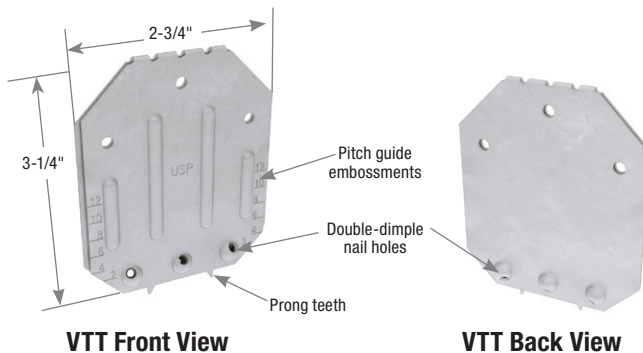
**Patents:** U.S. Patent No. 9,920,514 B1

**Installation:**

- Mark the location of the supporting truss located below the lower roof sheathing.
- Place the VTT flat against the valley truss, centered over the top chord of the truss below. Tap the top edge down with a hammer to engage the prong teeth.
- Nail the VTT to the bottom chord of the valley truss using (3) 10d x 1-1/2" nails.
- Install (3) 10d common nails through the double-dimples and drive them through the sheathing into the top chord of the supporting truss below. One nail will be centered in the top chord below. The other two nails are driven in at preset angles guided by the dimple holes.

**Alternate Installation for Ground/Pre-Placement of VTT**

- Mark the location of the supporting truss located below the lower roof sheathing. Center VTT horizontally on that mark.
- Use pitch guide embossments on part to locate the vertical position of VTT. Pitch numbers on connector are the numerator in the pitch slope ratio. (i.e. "6" indicates a 6/12 pitch, "12" indicates a 12/12 pitch, etc.)
- Secure the VTT to valley truss with (3) 10d x 1-1/2" nails.
- When valley truss is hoisted into proper position on roof, install (3) 10d common nails through the double-dimples and drive them through the sheathing into the top chord of the supporting truss below. One nail will be centered in the top chord below. The other two nails are driven in at a preset angles guided by the dimple holes.



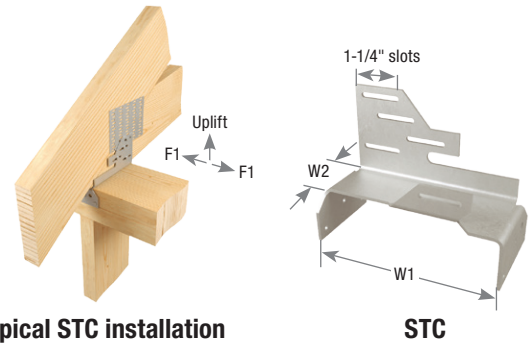
MiTek USP Stock No.	Ref. No.	Steel Gauge	Dimensions (in)		Fastener Schedule <sup>4</sup>				Supporting Roof Pitch	DF/SP Allowable Loads (Lbs.)		S-P-F Allowable Loads (Lbs.)		Code Ref.
			W	H	Supporting Framing		Valley Truss			Download <sup>3</sup>	Uplift <sup>1,2</sup>	Download <sup>3</sup>	Uplift <sup>1,2</sup>	
					Qty	Type	Qty	Type						
VTT	VTCR	18	2-3/4	3-1/4	3	10d	3	10d x 1-1/2	< 4/12	840	375	685	270	--
									4/12 to < 8/12	840	445	685	325	
									8/12 to 12/12	840	480	685	400	

1) Uplift Loads have been increased 60% for wind or seismic loads; no further increase shall be permitted.  
 2) Uplift loads are based on installation over 7/16" or 15/32" sheathing.  
 3) Downloads have been increased for snow, construction and wind loads; no further increase shall be permitted.  
 4) **NAILS:** 10d x 1-1/2 nails are 0.148" dia. x 1-1/2" long, 10d nails are 0.148" dia. x 3" long.

The STC provides uplift resistance by securing trusses to top plates. Slotted nail holes allow for horizontal movement as scissor trusses deflect.

- Materials:** 12 gauge  
**Finish:** G90 galvanizing  
**Codes:** See page 12 for Code Reference Chart

- Installation:**
- Use all specified fasteners. See Product Notes, page 20.
  - When installing, do not fully set nails.
  - Locate nails into the center of slots to allow for horizontal movement.



MiTek USP Stock No.	Ref. No.	Steel Gauge	Description	Dimensions (in)		Fastener Schedule <sup>2</sup>				DF/SP Allowable Loads (Lbs.)		S-P-F Allowable Loads (Lbs.)		Code Ref.
				W1	W2	Truss		Plate		Uplift <sup>1</sup> 160%	F1 160%	Uplift <sup>1</sup> 160%	F1 160%	
						Qty	Type	Qty	Type					
STC24	TC24	12	2 x 4 top plate	3-9/16	1-5/8	5	10d x 1-1/2	6	10d x 1-1/2	465	605	390	510	IBC, FL, LA
STC26	TC26	12	2 x 6 top plate	5-1/2	1-5/8	5	10d x 1-1/2	6	10d x 1-1/2					
STC28	TC28	12	2 x 8 top plate	7-1/4	1-5/8	5	10d x 1-1/2	6	10d x 1-1/2					

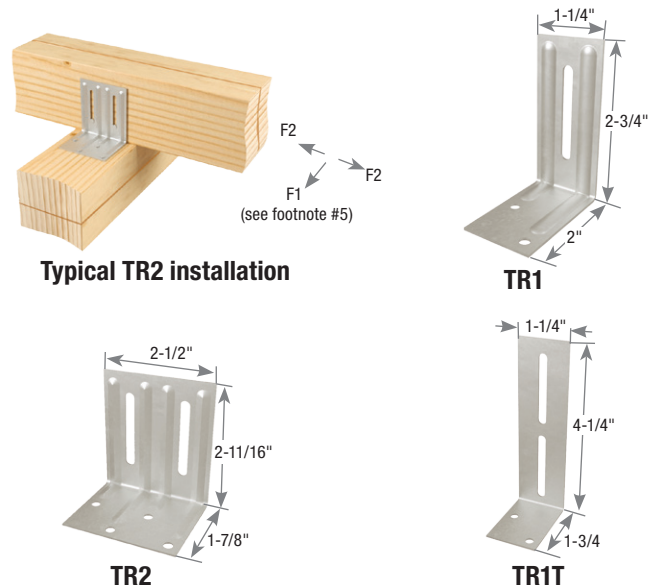
1) Uplift loads have been increased 60% for wind or seismic loads; no further increase shall be permitted.  
 2) **NAILS:** 10d x 1-1/2 nails are 0.148" dia. x 1-1/2" long.

## TR Roof Truss Ties

Slotted design allows truss to deflect without imposing load on wall below.

- Materials:** See chart  
**Finish:** G90 galvanizing  
**Codes:** See page 12 for Code Reference Chart

- Installation:**
- Use all specified fasteners. See Product Notes, page 20.
  - Do not fully set nails.
  - Locate nails into the center of slots.
  - **Due to the potential for squeaks, the TR series products are not recommended for floor applications.**



MiTek USP Stock No.	Ref. No.	Steel Gauge	Description	Fastener Schedule <sup>6</sup>				DF/SP Allowable Loads (Lbs.) <sup>1</sup>						Code Ref.
				Truss		Plate		Allowable Loads (Lbs.) <sup>1</sup>						
				Qty	Type	Qty	Type	Without Gap <sup>2</sup>		With 1/4" Gap <sup>3</sup>		With 1/2" Gap <sup>4</sup>		
								F1 <sup>5</sup> 160%	F2 160%	F1 <sup>5</sup> 160%	F2 160%	F1 <sup>5</sup> 160%	F2 160%	
TR1	STC	18	single slot	1	8d	2	8d	85	50	35	35	--	--	--
TR1T	STCT	16	single slot	1	8d	2	8d	240	--	130	--	80	--	
TR2	DTC	18	double slot	2	8d	4	8d	125	210	85	135	--	--	

1) Loads have been increased for short-term loading; no further increase allowed.  
 2) Truss must be bearing on top plate to achieve the allowable loads under "Without Gap".  
 3) Installed with maximum 1/4" space between rafter or truss and top plate under "With 1/4" Gap". Space is not limited to 1/4", where loads are not required.  
 4) Installed with maximum 1/2" space between rafter or truss and top plate under "With 1/2" Gap". Space is not limited to 1/2", where loads are not required.  
 5) To achieve F1 loads in both directions, clips must be installed on both sides of the truss and staggered to avoid nail interference.  
 6) **NAILS:** 8d nails are 0.131" dia. x 2-1/2" long.

# HTC Heavy Truss Deflection Clip



Slotted design allows truss to deflect without imposing load on wall below.

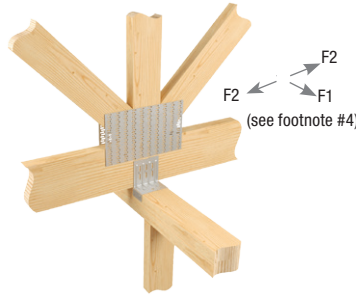
**Materials:** 16 gauge

**Finish:** G90 galvanizing

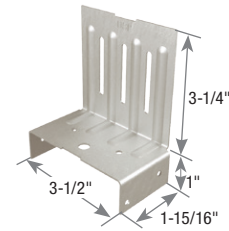
**Codes:** See page 12 for Code Reference Chart

**Installation:**

- Use all specified fasteners. See Product Notes, page 20.
- Do not fully set nails.



Typical HTC4 installation



HTC4

MiTek USP Stock No.	Ref. No.	Steel Gauge	Fastener Schedule <sup>4</sup>				DF/SP Allowable Loads (Lbs.) <sup>1</sup>				Code Ref.
			Plate		Truss/Rafter Qty	Type	Without Gap <sup>2</sup>		With 1-1/4" Gap <sup>3</sup>		
			Top Qty	Side Qty			F1 <sup>5</sup> 160%	F2 160%	F1 <sup>5</sup> 160%	F2 160%	
			Top Qty	Side Qty	Truss/Rafter Qty	Type	F1 <sup>5</sup> 160%	F2 160%	F1 <sup>5</sup> 160%	F2 160%	
HTC4	HTC4	16	2	4	3	10d x 1-1/2	255	525	55	295	IBC, FL, LA

- 1) Loads have been increased 60% for wind or seismic loads; no further increase shall be permitted.
- 2) Truss/Rafter must be bearing on top plate to achieve the allowable loads under "Without Gap".
- 3) When installed with maximum 1-1/4" space between truss/rafter and top plate, use loads under "With 1-1/4" Gap".
- 4) To achieve F1 loads in both directions, clips must be installed on both sides of the truss and staggered to avoid nail interference.
- 5) **NAILS:** 10d x 1-1/2 nails are 0.148" dia. x 1-1/2" long.

Plated Truss

## ZC Blocking Supports

ZC clips secure blocking between joists or trusses which provides support for drywall or sheathing.

**Materials:** See chart

**Finish:** G90 galvanizing

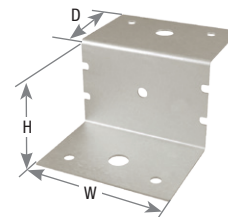
**Codes:** See page 12 for Code Reference Chart

**Installation:**

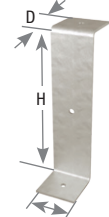
- Use all specified fasteners. See Product Notes, page 20.



Typical ZC installation



ZC2



ZC4

MiTek USP Stock No.	Ref. No.	Steel Gauge	Dimensions (in)			Fastener Schedule <sup>1</sup>				DF/SP Allowable Loads (Lbs.) <sup>2</sup>		Code Ref.
			W	H	D	Header		Blocking		Download 100%		
						Qty	Type	Qty	Type			
ZC2	Z2	20	2-1/4	1-9/16	1-1/2	2	10d x 1-1/2	2	10d x 1-1/2	490	--	
ZC4	Z4	12	1-1/2	3-9/16	1-3/8	2	10d x 1-1/2	1	10d x 1-1/2	420		
ZC24	Z28	28	2-9/32	1-9/16	1-3/8		10d x 1-1/2		10d x 1-1/2	--		
ZC34	Z38	28	2-9/32	2-9/16	1-5/16		10d x 1-1/2		10d x 1-1/2	--		

- 1) Allowable load shall not be increased for other load duration factors.
- 2) **NAILS:** 10d x 1-1/2 nails are 0.148" dia. x 1-1/2" long.

## T Hoist Plates

Engineered with a reinforced collar around the hoist hole for added strength.

**Materials:** 14 gauge

**Finish:** G90 galvanizing

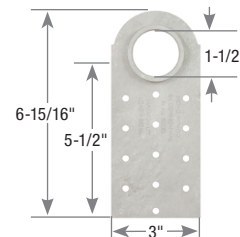
**Codes:** See page 12 for Code Reference Chart

**Installation:**

- Fill all nail holes that align with wood.



Typical T10 installation



T10

MiTek USP Stock No.	Ref. No.	Steel Gauge	Fastener Schedule <sup>1</sup>		Max Load (Lbs.)	Code Ref.
			Min. Qty	Type		
T10	CHC	14	10	8d common	800	--

1) **NAILS:** 8d nails are 0.131" dia. x 2-1/2" long.



Job site splicing of long trusses is made easier with Truss Field Splice Kits. The FS and FSS (for scissors trusses) includes a pair of plates, bolts, nuts, and a Splice Clip for top chord alignment. Allowable loads are sometimes limited by tension in the net section of the wood. Choose the bottom chord size and species that will satisfy the tension requirement. Analyze tension in the web to determine the required size.

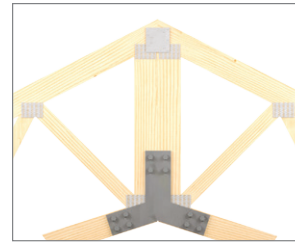
**Materials:** FS/FSS – See chart, bolts, and nuts included Splice Clip – 12 gauge

**Finish:** FS & FSS – Primer; Splice Clip – G90 galvanizing; Bolts – zinc plating

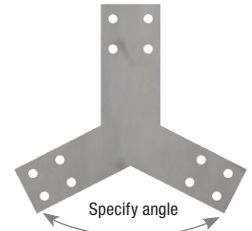
**Codes:** See page 12 for Code Reference Chart

**Installation:**

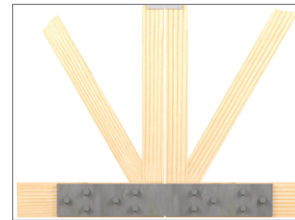
- Use all specified fasteners. See Product Notes, page 20.
- Position the two trusses, center one splice plate on the bottom chords and clamp in place for a drilling template. Install the Splice Clip at the top truss plate and fasten with (18) 10d (0.148" dia) x 1-1/2" nails. Drill through the bottom chord using splice plate as a template. Place splice plate on each side and bolt the connection firmly.



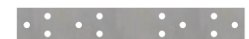
Typical FSS installation



FSS



Typical FS installation



FS



Splice Clip

MiTek USP Stock No.	Ref. No.	Steel Gauge	Truss Plies	Bolt Schedule		Chord Size	Allowable Loads (Lbs.) <sup>1,2</sup>			Code Ref.
				Qty	Size (in)		DF	SP	S-P-F	
							115%	115%	115%	
FS8B	--	7	1	8	3/4 x 3	2 x 6	4995	4845	3910	
						2 x 8	6695	6305	5240	
						2 x 10	7195	7565	6030	
FS8B-2	--	7	2	8	3/4 x 5	2 x 6	9995	9690	7820	
						2 x 8	13390	12615	10480	
						2 x 10	14130	14725	12140	
FS8B-3	--	7	3	8	3/4 x 7	2 x 6	14120	14540	11730	
						2 x 8	14145	14740	13070	
						2 x 10	14130	14725	13075	
FS12B	--	3	1	12	3/4 x 3	2 x 6	4995	4845	3910	
						2 x 8	6695	6305	5240	
						2 x 10	8320	7565	6510	
FS12B-2	--	3	2	12	3/4 x 5	2 x 6	9995	9690	7820	
						2 x 8	13390	12615	10480	
						2 x 10	16640	15125	13020	
FS12B-3	--	3	3	12	3/4 x 7	2 x 6	14990	14540	11730	
						2 x 8	20085	18920	15720	
						2 x 10	21770	22670	19530	
FSS8B	--	7	1	12	3/4 x 3	2 x 6	4995	4845	3910	
						2 x 8	6695	6305	5240	
						2 x 10	7195	7565	6030	
FSS8B-2	--	7	2	12	3/4 x 5	2 x 6	9995	9690	7820	
						2 x 8	13390	12615	10480	
						2 x 10	14130	14725	12140	
FSS12B	--	3	1	18	3/4 x 3	2 x 6	4995	4845	3910	
						2 x 8	6695	6305	5240	
						2 x 10	8320	7565	6510	
FSS12B-2	--	3	2	18	3/4 x 5	2 x 6	9995	9690	7820	
						2 x 8	13390	12615	10480	
						2 x 10	16640	15125	13020	

1) Allowable loads shall not be increased for other load duration factors.  
 2) Allowable loads are based on the lesser of the calculated bolt loads and the calculated wood tensile strength at the critical net section.  
 3) Wood tensile strengths are based on the Ft of 450 psi for S-P-F, 575 psi for DF-L, and approximately 540 psi for SP; and increased by the size factors in accordance with the NDS®.  
 4) Bolts shall conform to ASTM A 307 Grade A or better.

# ADTT-TZ Adjustable Deck Tension Tie



Deck collapses are often caused by failure of the connection where the deck is attached to the main structure due to little or no lateral capacity. ADTT-TZ is an Adjustable Deck Tension Tie designed to effectively transfer the out of plane lateral loads of the deck to the house structure.

**Features:**

- Exceeds “Hold-down Device” requirements per 2015 IRC, Section 507.2.4 [Figure R507.2.3(2)].
- Adjustable design allows lag screw installation at variable distance below deck joist.
- 2-hole break-out washer (BO-W) will work with multiple screw sizes.
- Blocking extensions not required.

**Materials:** 14 gauge

**Finish:** G-185 galvanizing

**Codes:** See page 12 for Code Reference Chart

**Patents:** U.S. Patent No. 9,809,974

**Installation:**

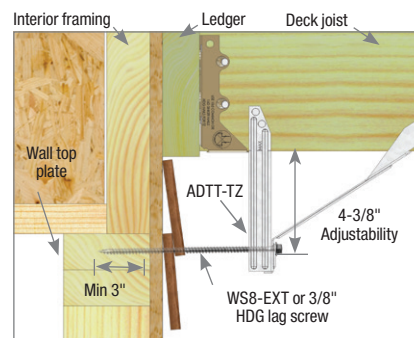
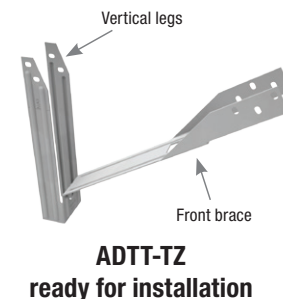
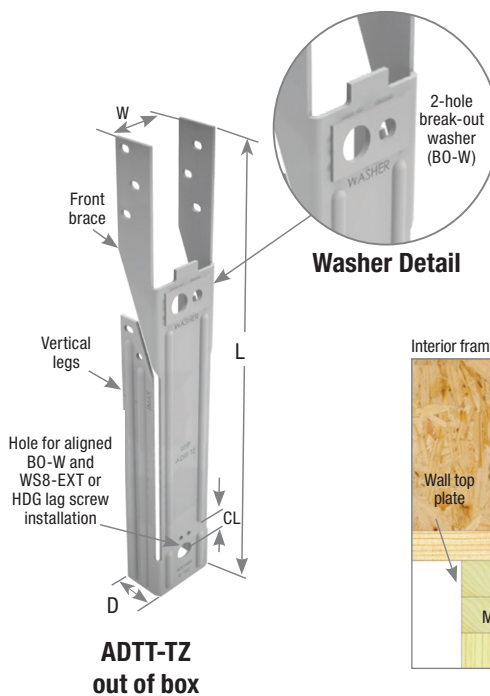
- Install with MiTek USP WS8-EXT wood screw or 3/8" HDG lag screw. WS8-EXT or 3/8" HDG lag screws may be installed adjacent or up to 4-3/8" below deck joist (see Figure A).
- Drive screw horizontally and aligned vertically with the deck joist into the wall top plate of the main (house) structure.
- Install four (4) of the specified joist fasteners into vertical legs. (Two (2) on each side of deck joist).
- Secure front brace with six (6) specified joist fasteners.
- Re-tighten the WS8-EXT or 3/8" HDG lag screw as needed to fully engage with the ADTT-TZ. **DO NOT OVERDRIVE.** Note: Minimum 3" thread penetration required for proper installation of WS8-EXT or HDG lag screw.
- For detailed installation instructions refer to MiTek-US.com.



**Typical ADTT-TZ full extension installation**  
**Extended Installation**



**Typical ADTT-TZ flush installation**  
**Contracted Installation**



**Figure A**

MiTek USP Stock No.	Ref. No.	Steel Gauge	Dimensions (in)				Fastener Schedule				Installation Type <sup>1</sup>	DF/SP Allowable Tension (Lbs.)		S-P-F Allowable Tension (Lbs.)	Corrosion Finish	Code Ref.
			W	L	D	CL	Wall		Joist			160%	Δ (in) at 160% <sup>2</sup>	160%		
							Qty	Type <sup>3,4,5</sup>	Qty	Type <sup>6,8</sup>						
ADTT-TZ	DTT1Z	14	1-9/16	10-1/2	15/16	3/8	1	3/8" HDG Lag Screw	10	10d x 1-1/2	Contracted	820	0.070	820	IBC, FL, LA	
									10	LL915	Contracted	820	0.121			
									10	LL915	Extended	790	0.114			
									10	LL915	Extended	790	0.114			
							1	WS8-EXT	10	10d x 1-1/2	Contracted	830	0.080	780		
									10	LL915	Contracted	835	0.113			
									10	LL915	Extended	830	0.121			
									10	LL915	Extended	790	0.114			
ADTT-TZKT <sup>7</sup>	DTT1Z-KT	14	1-9/16	10-1/2	15/16	3/8	1	WS8-EXT	10	LL915	Contracted	830	0.121	780	--	
									10	LL915	Contracted	830	0.121			
									10	LL915	Extended	790	0.114			

1) Allowable loads are for the ADTT-TZ installed tight to the bottom of the joist (Contracted) or 4" from bottom of joist to ADTT-TZ bend line (Extended).  
 2) Deflections are derived from static, monotonic load tests of devices connected to DF wood members with specified fasteners.  
 3) WS8-EXT is a 1/4" dia. x 8" long double barrier coated screw sold by MiTek and must be ordered separately if not purchasing the kit. The minimum thread penetration into the top plate of the wall framing is 3".  
 4) 3/8" HDG Lag Screw is an ASTM A307 Grade A lag screw with a thread diameter of 3/8" and is hot-dip galvanized to ASTM A153 standards. The minimum thread penetration into the top plate of the wall framing is 3". Lag screws are available at your local hardware store and must be purchased separately.

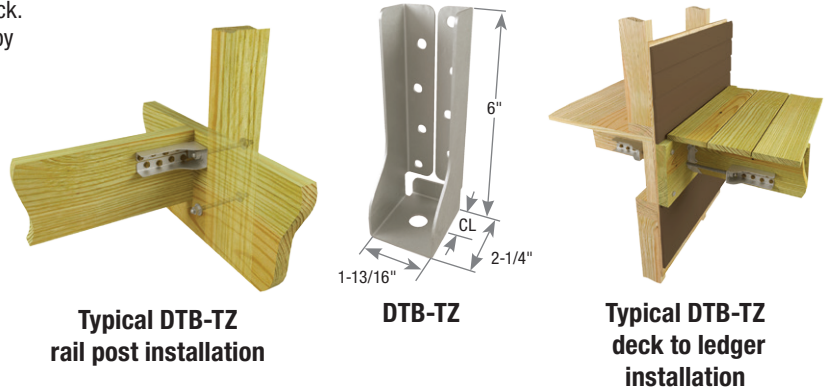
5) Check with your siding manufacturer for recommendations for fastening through your siding material.  
 6) LL915 denotes a MiTek USP LumberLok Screw, #9 x 1-3/8" long and must be ordered separately if not purchasing the kit.  
 7) ADTT-TZKT is a kit with (4) ADTT-TZ packaged with MiTek USP WS8-EXT screws and LL915 LumberLok screws.  
 8) Nails: 10d x 1-1/2 nails are 0.148" dia. x 1-1/2" long.

**Corrosion Finish** ■ Stainless Steel ■ Gold Coat ■ HDG ■ Triple Zinc

Deck Tie Back reinforces the connection of rail posts to a deck. Also provides lateral strength of deck-to-ledger attachment by securing deck to house framing.

**Materials:** 14 gauge  
**Finish:** G-185 galvanizing  
**Options:** See chart for Corrosion Finish Options  
**Codes:** See page 12 for Code Reference Chart, IRC R507.1

- Installation:**
- Use all specified fasteners. See Product Notes, page 20.
  - Install with MiTek's THR 1/2" threaded rod or equivalent.
  - Drive WS15-EXT wood screws into joist.
  - Re-install threaded rod or anchor bolt. Secure with washer and nut.
  - Tighten anchor bolt nuts finger tight to base plus 1/3 to 1/2 additional turns with wrench.



MiTek USP Stock No.	Ref. No.	Steel Gauge	Dimensions (in)				Fastener Schedule				DF/SP Allowable Tension (Lbs.)		S-P-F Allowable Tension (Lbs.)		Corrosion Finish	Code Ref.
			W	L	D	CL	Wall		Joist		160%	Δ (in) at 160% <sup>2</sup>	160%	160%		
							Qty	Bolt <sup>3</sup>	Qty	Screws <sup>1</sup>						
DTB-TZ	DTT2Z, FSC	14	1-13/16	6	2-1/4	1-1/8	1	1/2	8	WS15-EXT	1835	0.119	1510		IBC, FL, LA	

**Corrosion Finish**

- Stainless Steel
- Gold Coat
- HDG
- Triple Zinc

1) WS15-EXT Wood Screws are 1/4" dia. x 1-1/2" long and are included with DTB-TZ Deck Tie-Backs.  
 2) Deflections are derived from static, monotonic load tests of devices connected to DF wood members with specified fasteners.  
 3) **Minimum ASTM A307 bolt or 1/2" threaded rod with cut washer and hex nut.**  
 New products or updated product information are designated in **blue font**.

## CSH Concealed Stringer Hanger

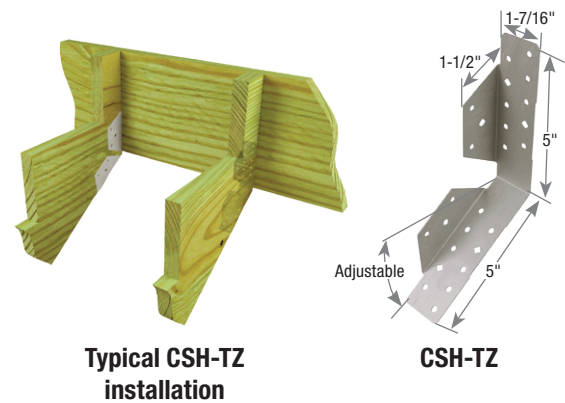
The CSH-TZ concealed stringer hanger provides a method of connecting a stair stringer with a hidden hanger. The seat of the hanger is adjustable to match the slope of the stair stringer.

The reversible design allows the connector to be used on the left, right, or interior stringers. The CSH-TZ may be used with MiTek's SCA Stair Angles for a complete, easy-to-use stair framing solution.

**Materials:** 18 gauge  
**Finish:** G-185 galvanizing  
**Options:** See chart for Corrosion Finish Options  
**Codes:** See page 12 for Code Reference Chart  
**Patents:** U.S. Patent No. 7,631,463

- Installation:**
- Use all specified fasteners. See Product Notes, page 20.
  - **Bend angle only once.**

- Steps:**
1. Attach CSH-TZ to header with tabs positioned towards the inside of the stringer member.
  2. Adjust the seat of the CSH-TZ to match the slope of the stringer member. Diamond shaped holes in the connector allow temporary installation of woodscrews to aid in installation of the CSH-TZ.
  3. Install 10d x 1-1/2" HDG nails into the stringer and rim/band joist.



MiTek USP Stock No.	Ref. No.	Steel Gauge	Fastener Schedule <sup>2</sup>				DF/SP Allowable Loads (Lbs.)				S-P-F/Hem Fir Allowable Loads (Lbs.)				Corrosion Finish	Code Ref.
			Rim/Band	Stringer		Type	100%	115%	125%	Uplift 160%	100%	115%	125%	Uplift 160%		
				Joist Qty	Wide Face Qty											
CSH-TZ	LSCZ	18	8	4	1	10d x 1-1/2 HDG	890	890	890	370	725	725	725	305	IBC, FL, LA	

1) Uplift loads are increased 60% for wind or seismic loads; no further increase shall be permitted.  
 2) **NAILS:** 10d x 1-1/2 HDG nails are 0.148" dia. x 1-1/2" long.  
 New products or updated product information are designated in **blue font**.

**Corrosion Finish**

- Stainless Steel
- Gold Coat
- HDG
- Triple Zinc

Stair angles simplify stair construction. There is no need to calculate and notch stair stringers. Stronger and safer than wood blocking, and the angle and fasteners are hidden from view.

**Materials:** 12 gauge

**Finish:** G-185 galvanizing

**Options:** See chart for Corrosion Finish Options

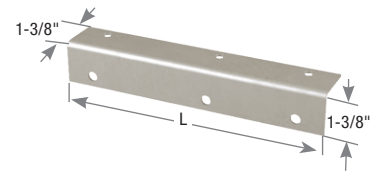
**Codes:** See page 12 for Code Reference Chart

**Installation:**

- Use all specified fasteners. See Product Notes, page 20.
- MiTek USP WS15-EXT (1/4" dia x 1-1/2") wood screws are not supplied with SCA angles.
- Use the SCA9-TZ for single 2x10 stair treads. Use the SCA10-TZ for double 2 x 6 stair treads.
- To calculate stair construction do the following:
  1. Find the number of steps needed by taking the vertical drop from the deck surface to grade. Divide by 7. Round off to the nearest whole number. (Ex: Vertical drop of 39" divided by 7 equals 5.57" rounded off is 6")
  2. Find the step rise by dividing the vertical drop by the number of steps (39" divided by 6 = 6.5")
  3. Find the step run by measuring the depth of your tread board (Ex: (2) 2x6s have a run of 11-1/4")
  4. Find the stairway span by multiplying the run by the number of treads minus one (Ex: 11-1/4" x 5 = 56-1/4")
- Using the above calculations, mark stair angle locations on each stringer. Attach a stair angle to the inside of each stringer at the marked locations. Attach stringers to deck rim joist and railing posts. Position treadboards on angles and fasten from below.



**Typical SCA9-TZ installation**



**SCA9-TZ**



**Typical SCA10-TZ installation**



MiTek USP Stock No.	Ref. No.	Steel Gauge	L (in)	Fastener Schedule <sup>2,3</sup>		DF/SP Allowable Loads (Lbs.) <sup>1</sup>	Corrosion Finish	Code Ref.
				Qty	Type			
SCA9-TZ	TA9Z	12	9	6	WS15-EXT	445		IBC, FL, LA
SCA10-TZ	TA10Z	12	10	8	WS15-EXT	595		

1) Loads assume rise over run of 7/11.

2) WS15-EXT Wood Screws are 1/4" dia. x 1-1/2" long and are not included with SCA angles.

3) HDG lag screws may be substituted for specified WS15-EXT screws with no load reduction.

New products or updated product information are designated in **blue font**.

**Corrosion Finish** Stainless Steel Gold Coat HDG Triple Zinc

Connects deck boards to joists without face nails or screws. Eliminates rust stains on decks, as well as splintering or wood rot caused by screw or nail “craters”. The DC50-TZ works like tongue-in-groove flooring and is easy to install. Raised dimples on the clip provide consistent spacing between deck boards.

**Materials:** 20 gauge

**Finish:** G-185 galvanizing

**Options:** See chart for Corrosion Finish Options

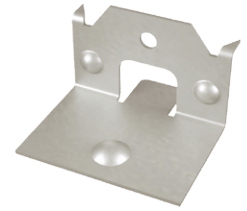
**Codes:** See page 12 for Code Reference Chart

**Installation:**

- Use all specified fasteners. See Product Notes, page 20.
- Fits 1-1/8" or thicker decking.
- Fasten the first deck board onto the joists by toenailing up through the joist below into the deck board. Be sure no sharp points protrude above the deck surface. For subsequent deck board rows, nail DC50-TZ's onto the deck board edge, positioned 2" from each joist. Slide the deck board along the joist until the DC50-TZ “lip” is under the previously laid deck board. Toenail the deck board’s exposed edge to the joist. Repeat until decking is completed. The last deck board will require toenailing up from below to secure the outside edge.



**Typical DC50-TZ installation**



**DC50-TZ**

MiTek USP Stock No.	Ref. No.	Steel Gauge	Fastener Schedule <sup>1,2</sup>		Corrosion Finish	Code Ref.
			Qty	Type		
DC50-TZ	DBT1Z	20	1	8d x 1-1/2 HDG		--

1) Use with 1-1/8" or thicker wood decking.

2) **NAILS:** 8d x 1-1/2 nails are 0.131" dia. x 1-1/2" long.

**Corrosion Finish** Stainless Steel Gold Coat HDG Triple Zinc

**ML** Angles

ML angles are multi-purpose angles that install easily with MiTek’s WS15 wood screws. The staggered fastener pattern allows for back-to-back installations.

**Materials:** 12 gauge

**Finish:** G-185 galvanizing

**Options:** See chart for Corrosion Finish Options

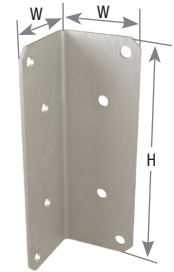
**Codes:** See page 12 for Code Reference Chart

**Installation:**

- Use all specified fasteners. See Product Notes, page 20.
- WS15 (1/4" dia x 1-1/2" long) are not supplied with ML angles.



**Typical ML26-TZ installation**  
(ML24-TZ similar)



**ML26-TZ**  
(ML24-TZ similar)

MiTek USP Stock No.	Ref. No.	Steel Gauge	Dimensions (in)		Fastener Schedule <sup>2,3</sup>			DF/SP Allowable Loads (Lbs.) <sup>1</sup>				S-P-F Allowable Loads (Lbs.) <sup>1</sup>				Corrosion Finish	Code Ref.
			W	H	Header Qty	Joist Qty	Type	F1				F1					
								100%	115%	125%	160%	100%	115%	125%	160%		
ML24-TZ	ML24Z	12	2	4	3	3	WS15	645	645	645	645	540	540	540	540		IBC, FL, LA
ML26-TZ	ML26Z	12	2	6	4	4	WS15	920	1060	1075	1075	755	865	905	905		FL, LA

1) Allowable loads have been increased 60% for wind and seismic loads; no further increase shall be permitted.

2) WS15 Wood Screws are 1/4" dia. x 1-1/2" long and are not included with angles.

3) For exterior applications use WS15-EXT screws with exterior coat finish.

New products or updated product information are designated in **blue font**.

**Corrosion Finish** Stainless Steel Gold Coat HDG Triple Zinc

**PRT15-TZ** – is for 1-5/8" vertical pipe posts (1-7/8" outside pipe diameter). Can be field bent 90° for outside corner installations.

**PRT2-TZ / PRT2H-TZ** – is for 2" vertical pipe posts (2-3/8" outside pipe diameter). Can be field bent 90° for outside corner installations.

**PRTIC2-TZ** – is for inside corner installations. For 2" vertical pipe posts (2-3/8" outside pipe diameter).

**Materials:** See chart

**Finish:** G-185 galvanizing

**Options:** See chart for Corrosion Finish Options

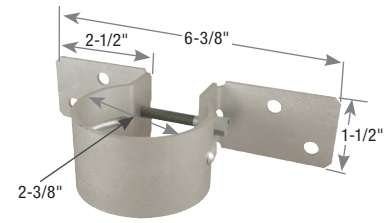
**Codes:** See page 12 for Code Reference Chart

**Installation:**

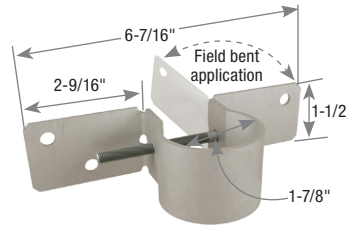
- Use all specified fasteners. See Product Notes, page 20.
- PRT15-TZ, PRT2H-TZ and PRTIC2-TZ - 1/4" Self Tapping Bolts are supplied with PRT models.
- Install self tapping bolts with 3/8" socket in predrilled holes.
- PRT2-TZ fastens with (1) 1/4" carriage bolt and nut (included) for tightening PRT2-TZ to pipe and (4) 1/4" HDG lag bolts for attaching tie to rail.
- Install 3 to 4 PRT's per pipe.
- PRT15-TZ, PRT2-TZ and PRT2H-TZ may be bent once to fit corner and angled conditions.



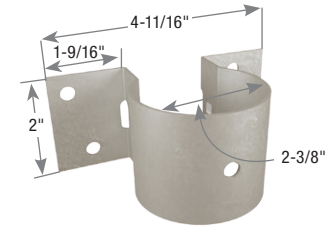
**Typical PRT2H-TZ installation**  
PRT15-TZ & PRT2-TZ similar



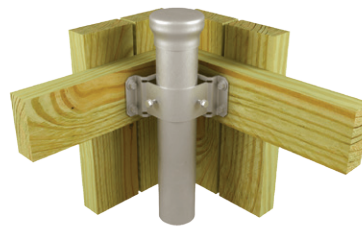
**PRT2H-TZ**



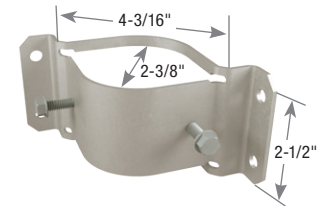
**PRT15-TZ**



**PRT2-TZ**



**Typical PRTIC2-TZ installation**



**PRTIC2-TZ**

MiTek USP Stock No.	Ref. No.	Steel Gauge	Dimensions (in)		Fastener Schedule <sup>1</sup>				Corrosion Finish	Code Ref.
			L	H	Pipe		Rail			
					Qty	Type	Qty	Type		
PRT15-TZ	PGT1.5Z-R	12	6-7/16	1-1/2	1	1/4" Self Tapping Bolt	4	1/4" HDG Lag Bolt		
PRT2-TZ	PGT2E	16	4-11/16	2	1	1/4" HDG Carriage Bolt	4	1/4" HDG Lag Bolt		
PRT2H-TZ	PGT2Z-R, PGT2A	12	6-3/8	1-1/2	1	1/4" Self Tapping Bolt	4	1/4" HDG Lag Bolt		--
PRTIC2-TZ	PGTIC2Z-R	12	4-3/16	2-1/2	2	1/4" Self Tapping Bolt	4	1/4" HDG Lag Bolt		

1) WS15-EXT wood screws can be substituted for specified lag bolts.  
 2) Install self tapping bolts (included) with 3/8" socket in predrilled holes.  
 3) Install 3 to 4 PRT's per pipe.  
 4) PRT15, PRT2 and PRT2H Pipe Rail Ties may be bent once to fit corner and angled conditions.

**Corrosion Finish** ■ Stainless Steel ■ Gold Coat ■ HDG ■ Triple Zinc

**ERB24** – Designed to mount prefabricated fence sections and works with 2x4 horizontal section rails.

**FB26** – Secures 2x6 rails to wood posts.

**FRB24** – Secures continuous 2x4 rails to wood posts. Pre-punched holes allow installers to splice 2x4 rail ends within the bracket.

**Materials:** See chart

**Finish:** G-185 galvanizing

**Options:** See chart for Corrosion Finish Options

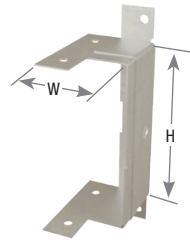
**Codes:** See page 12 for Code Reference Chart

**Installation:**

- Use all specified fasteners. See Product Notes, page 20.



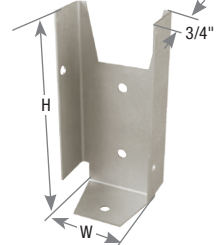
Typical ERB24-TZ installation



ERB24-TZ



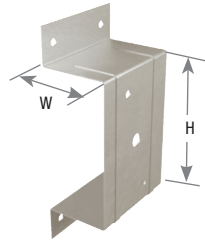
Typical FB24-TZ installation



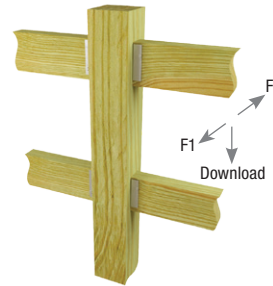
FB24-TZ



Typical FRB24-TZ installation



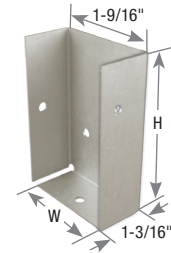
FRB24-TZ



Typical FB26-TZ installation



FB26-TZ



FB23-TZ



FB14-TZ

Rail Size	MiTek USP Stock No.	Ref. No	Steel Gauge	Dimensions (in)		Fastener Schedule <sup>2</sup>				DF/SP Allowable Loads (Lbs) <sup>1</sup>				Corrosion Finish	Code Ref.
				W	H	Rail		Post		Download		F1			
						Qty	Type	Qty	Type	100%	115%	100%	115%		
1 x 4	FB14-TZ	--	20	3/4	3-1/2	3	14 ga. x 3/4 HDG	2	8d x 1-1/2 HDG	--	--	--	--		
2 x 3	FB23-TZ	--	20	1-9/16	2-3/8	3	8d x 1-1/2 HDG	4	8d x 1-1/2 HDG	--	--	--	--		
2 x 4	ERB24-TZ	--	18	1-1/2	3-9/16	4	8d x 1-1/2 HDG	3	8d HDG	--	--	--	--		
	FB24-TZ	FB24Z, FBR24Z	20	1-9/16	3-3/8	3	8d x 1-1/2 HDG	2	8d HDG	--	--	--	--		--
	FRB24-TZ	--	18	1-9/16	3-9/16	2	10d x 1-1/2 HDG	4	10d HDG	--	--	--	--		
2 x 6	FB26-TZ	FB26	18	1-9/16	5	4	10d x 1-1/2 HDG	4	10d x 1-1/2 HDG	330	330	350	400		
						4	LL915	4	LL915	315	360	315	360		

1) Allowable loads have been increased 15% for short duration loading. No further increase is permitted.

2) **NAILS:** 8d x 1-1/2 nails are 0.131" dia. x 1-1/2" long, 8d nails are 0.131" dia. x 2-1/2" long, 10d x 1-1/2 nails are 0.148" dia. x 1-1/2" long, 10d nails are 0.148" dia. x 3" long, LL915 denotes a LumberLok screw #9 x 1-3/8" long.

**Corrosion Finish** ■ Stainless Steel ■ Gold Coat ■ HDG ■ Triple Zinc

# PCP Plastic Post Caps

These seamless caps keep water off post tops, protecting wood from moisture damage. The PCP's plastic construction is corrosion-proof and paintable. Not available in rough or full lumber sizes.

**Materials:** Hi-impact plastic

**Finish:** Gray color

**Codes:** See page 12 for Code Reference Chart

**Installation:**

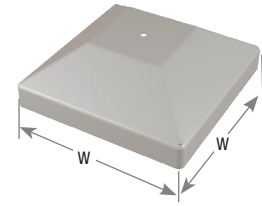
- Fasten cap to post top with (1) 8d HDG or 10d HDG nail.

Post / Column Size <sup>1</sup>	USP Stock No.	Ref. No.	Dimension (in)	Color	Code Ref.
			W		
4 x 4	PCP44	DPPC4BK	3-5/8	Gray	120
6 x 6	PCP66	DPPC6BK	5-5/8	Gray	

1) Not available in rough or full lumber sizes.



Typical PCP44 installation



PCP66

## SFP / SMP Fence Post Connectors

Take the work out of fence post installation and repair with the Speedpost, SFP30, and Speedmender, SMP. The Speedpost is used to install 4x4 fence posts without digging post holes or pouring concrete. The Speedmender plates act as reinforcement brackets for rotted or damaged 4x4 fence posts.

**SFP30** – For 6' nominally-sized 4x4 fence posts.

**SMP** – For nominally-sized 4x4 posts.

**Materials:** 13 gauge

**Finish:** Paint

**Patent:** #7,152,841

**Codes:** See page 12 for Code Reference Chart

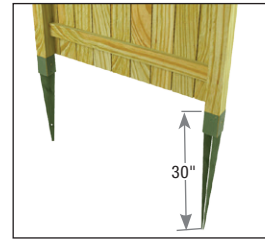
**Installation:**

- Step-by-step installation instructions are labeled onto each product.

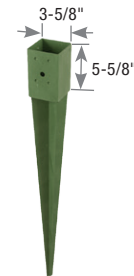
Post Size	USP Stock No.	Ref. No.	Steel Gauge	Fastener Schedule <sup>2</sup>		Code Ref.
				Qty	Type	
4 x 4	SFP30	FPBS44	13	3	1/4" HDG Lag Bolt	120
4 x 4	SMP <sup>1</sup>	FPBM44	13	20	10d HDG	

1) Fastener schedule is per pair of SMP's.

2) **NAILS:** 10d nails are 0.148" dia. x 3" long.



Typical SFP30 installation



SFP30



Typical SMP installation



SMP

## BD Bolt Down

Anchors 4x4 post to wood or concrete surfaces.

**Materials:** 13 gauge

**Finish:** Paint

**Patents:** U.S. Patent No. 7,152,841

**Codes:** See page 12 for Code Reference Chart

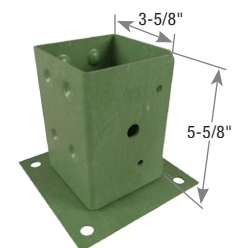
**Installation:**

- Use all specified fasteners. See Product Notes, page 20.
- **Not rated for overturning resistance. Not recommended for unrestrained posts.**

Post Size	USP Stock No.	Ref. No.	Steel Gauge	Fastener Schedule		Code Ref.
				Qty	Type (in)	
4 x 4	BD	FPBB44	13	3	1/4 x 1-1/2 HDG Lag Bolt	120



Typical BD installation



BD

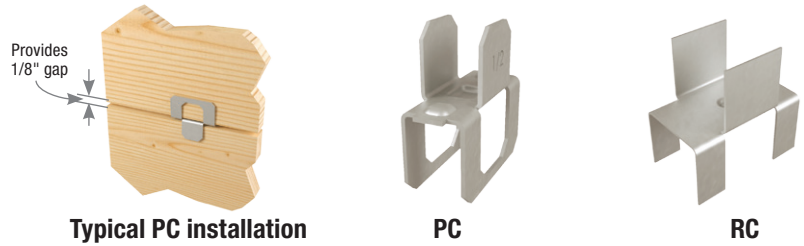


Steel plywood clips. All models feature embossed dimples to provide 1/8" gap.

**Materials:** See chart

**Finish:** G90 galvanizing

**Codes:** See page 12 for Code Reference Chart



Span Rating <sup>1</sup>	MiTek USP Stock No.	Ref. No.	Steel Gauge	Maximum Span <sup>1</sup>		Plywood Thickness (in)	PC's Per Span	Code Ref.
				With PC	Without PC			
24	RC38-250	PSCL3/8	18	24	20	3/8	1	--
	PC716	PSCL7/16	20	24	24	7/16	1	
32	PC1532	PSCL15/32, PSCA15/32	20	32	28	15/32	1	
	PC12	PSCL1/2	20	32	28	1/2	1	
40	PC1932	PSCL19/32	20	40	32	19/32	2	
	PC58	PSCL5/8	20	40	32	5/8	2	
48	PC34	PSCL3/4	20	48	36	3/4	2	

- 1) Based on code specified allowable spans for panel sheathing continuous over two or more spans with plywood strength axis perpendicular to supports.
- 2) Applicable to roof sheathing.
- 3) Applies to panels 24" or wider.
- 4) Uniform load deflection limitations 1/180 of span under live load plus dead load or 1/240 under live load only.

## DC Drywall Clip

Drywall clips or "stops" help support drywall or wood paneling and reduce wood blocking on top plates, end walls, and corners.

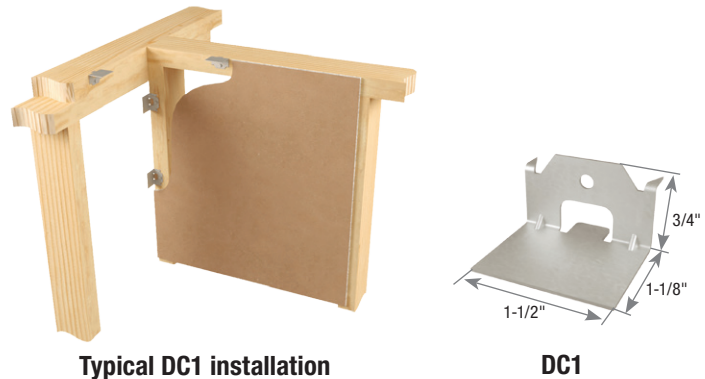
**Materials:** 20 gauge

**Finish:** G90 galvanizing

**Codes:** See page 12 for Code Reference Chart

**Installation:**

- Use 8d nails to install DC1, 16" on-center or less.



MiTek USP Stock No.	Ref. No.	Steel Gauge	Fastener Schedule <sup>1</sup>		Code Ref.
			Qty	Type	
DC1	DS	20	1	8d	--

1) **NAILS:** 8d nails are 0.131" dia. x 2-1/2" long.

## IS Insulation Supports

Insulation supports secure batt-type insulation in place between joists. Chisel-cut ends dig into joists for permanent holding. Easy to install in hard-to-reach crawl spaces.

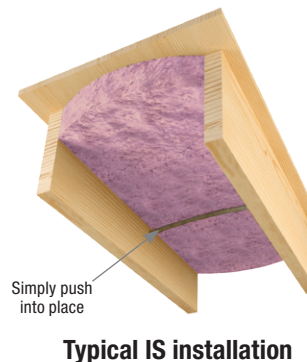
**Materials:** 13 gauge carbon steel wire

**Finish:** None

**Codes:** See page 12 for Code Reference Chart

**Installation:**

- Use IS16 for joist spaced 16" O.C. and IS24 for 24" O.C. spacing.
- Position insulation batt in place between joists. Hold IS unit at the center and push into place.
- Wear gloves and safety glasses during installation.



MiTek USP Stock No.	Ref. No.	Steel Gauge	Joist Spacing	Dimensions (in)		Code Ref.
				Overall Length		
IS16	IS16-R100	13	16" O. C.	15-1/2"		--
IS24	IS24-R100	13	24" O. C.	23-1/2"		--

Connectors for homeowner / D.I.Y. Projects.

**TTA12-TZ** – an angle connects two 1x wood members at 90° angles.

**TTA2-TZ** – an angle connects two 2x wood members at 90° angles.

**TTB22-TZ** – a bracket connects two intersecting 2x wood members at 90° angles.

**TTC24-TZ** – a corner tie connects 2x wood members at 90° to the corner of a 2x4 post. Mirror design allows for post to be oriented in either direction.

**TTC42-TZ** – a corner tie connects 2x wood members at 90° to the corner of a 4x4 post.

**TTF22-TZ** – a bracket connects 2x wood members to opposite sides of a 2x4 or 4x4 post.

**TTR-TZ** – a clip connects a 2x wood member to the face of another wood member.

**TTU2-TZ** – a U-clip connects 2x wood members crossing at 90°.

**Materials:** See chart

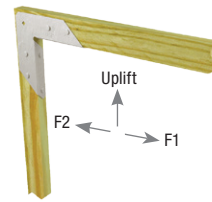
**Finish:** G-185 galvanizing

**Options:** See chart for Corrosion Finish Options

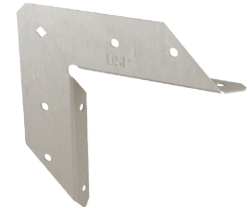
**Codes:** See page 12 for Code Reference Chart

**Installation:**

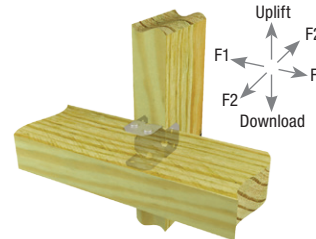
- Use all specified fasteners. See Product Notes, page 20.
- MiTek LumberLok LL915 (#9 x 1-3/8" long) wood screws are not supplied with connectors.



Typical TTA12-TZ installation



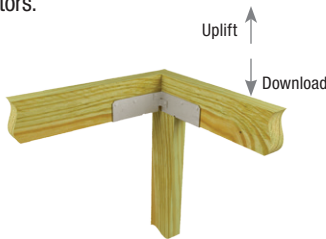
TTA12-TZ (TTA2-TZ Similar)



Typical TTB22-TZ installation



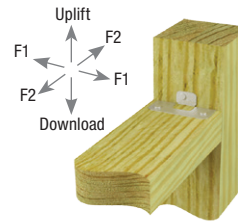
TTB22-TZ



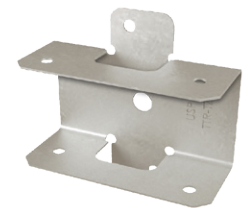
Typical TTC24-TZ installation



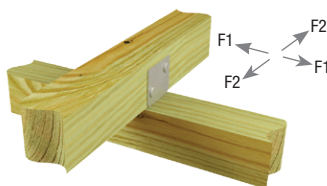
TTC24-TZ (TTC42-TZ Similar)



Typical TTR-TZ installation



TTR-TZ



Typical TTU2-TZ installation



TTU2-TZ



Typical TTF22-TZ installation



TTF22-TZ

MiTek USP Stock No.	Ref. No.	Steel Gauge	Post Size	Joist Size	Fastener Schedule <sup>1</sup>				DF/SP Allowable Loads (Lbs.) <sup>2,3</sup>				Corrosion Finish	Code Ref.
					Post		Joist (Total)		Download 100%	Uplift 100%	F1 100%	F2 100%		
					Qty	Type	Qty	Type						
TTA12-TZ	RTA12	18	1x	1x	4	LL915	4	LL915	--	205	190	205		
TTA2-TZ	RTA2Z	16	2x	2x	4	LL915	4	LL915	--	185	255	185		
TTU2-TZ	RTU2	18	2x	2x	2	LL915	4	LL915	--	--	210	210		
TTR-TZ	RTR	20	2x	2x	2	LL915	4	LL915	210	210	210	155		
TTB22-TZ	RTB22	20	2x	2x	4	LL915	4	LL915	360	360	360	250		--
TTF22-TZ	RTF2Z	18	2 x 4	2x	4	LL915	8	LL915	420	265	--	--		
TTC24-TZ	RTC24Z	18	2 x 4	2x	9	LL915	8	LL915	475	415	--	--		
TTC42-TZ	RTC42, RTC42Z	18	4 x 4	2x	14	LL915	8	LL915	735	420	--	--		

1) LL915 denotes a LumberLok Screw, #9 x 1-3/8" long.

2) TTF22-TZ: Allowable loads must be equally distributed on both joists.

3) TTC24-TZ and TTC42-TZ: Allowable loads listed in this table are for each joist being carried by the post.

**Corrosion Finish**

- Stainless Steel
- Gold Coat
- HDG
- Triple Zinc

Easy-to-install plates protect plumbing and power/communication wiring from nail or screw penetration. 16 gauge steel conforms to protection shield plate requirements of the National Electrical Code and International Plumbing Code.

**ICPL58** – Installs with nails.

**KNS1 / PL4** – Prongs allow for quick installation.

**Materials:** 16 gauge

**Finish:** ICPL516-TZ – G-185 galvanizing;  
All others – G90 galvanizing

**Options:** See chart for Corrosion Finish Options

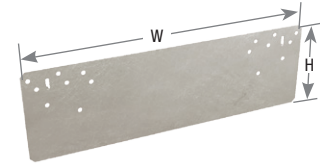
**Codes:** See page 12 for Code Reference Chart,  
IRC 2603.2.1 & R602.6.1, IBC 2308.5.8,  
IPC 305.6

**Installation:**

- Use all specified fasteners. See Product Notes, page 20.



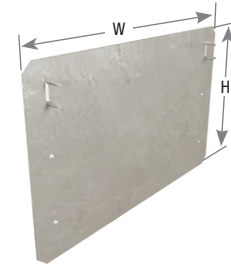
Typical ICPL516-TZ installation



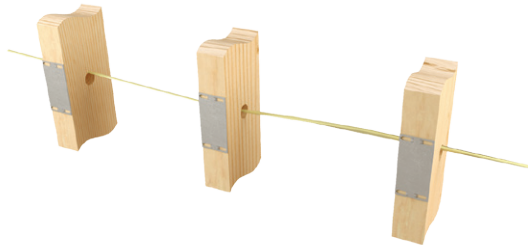
ICPL516-TZ



Typical ICPL58 installation



ICPL58



Typical KNS1 & PL4 installation



KNS1



PL4

MiTek USP Stock No.	Ref. No.	Steel Gauge	Dimensions (in)		Fastener Schedule <sup>2</sup>		Installation Type	DF/SP Allowable Loads (Lbs.) <sup>1</sup>	S-P-F Allowable Loads (Lbs.) <sup>1</sup>	Corrosion Finish	Code Ref.
			W	H	Qty	Type					
ICPL58	--	16	8-1/16	5	4	8d or prongs	--	--			PR
PL4	NS2	16	2	5	--	prongs	--	--			
KNS1	NS1	16	1-1/2	3	--	prongs	--	--			
ICPL516-TZ	PSPN516Z	16	16-1/4	5	12	16d HDG + prongs	Sill Plate	1355	1160		
					16	16d HDG + prongs	Double Top Plate	1805	1550		

1) Allowable loads have been increased 60% for wind or seismic loads; no further increase shall be permitted.

2) **NAILS:** 8d nails are 0.131" dia. x 2-1/2" long, 16d nails are 0.162" dia. x 3-1/2" long.

**Corrosion Finish** ■ Stainless Steel ■ Gold Coat ■ HDG ■ Triple Zinc

The HFS Hardy Frame® Saddle is a 14 gauge steel channel intended to be used as a splice at locations where plumbing or other vertical penetrations destroy the structural integrity of a wall's top plates.

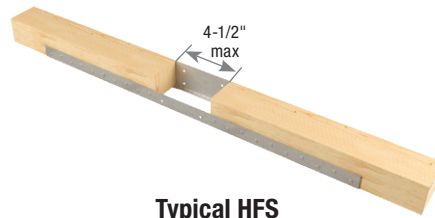
**Materials:** 14 gauge

**Finish:** G60 galvanizing

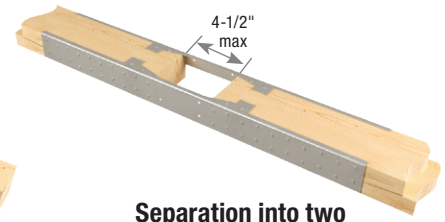
**Codes:** See page 12 for Code Reference Chart

**Installation:**

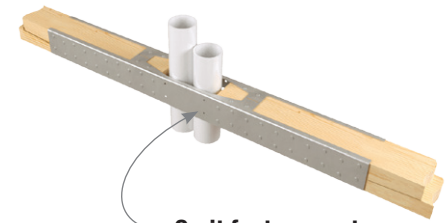
- Use all specified fasteners. See Product Notes, page 20.
- The Saddle can be installed over the top or from the underside of the top plates, and is capable of resisting both tension and compression loads in a clearspan of up to 4-1/2".
- For wall depths greater than 3-1/2", or to install after plumbing lines have been run, the product can be separated into two "L" shapes by gripping the legs of the channel and flexing the top surface along the serration lines.



**Typical HFS installation to underside of double top plates.**



**Separation into two "L" shapes at 6" and greater depths**



**Omit fasteners at first holes when the end distance is less than 1"**

MiTek USP Stock No.	Ref. No.	Steel Gauge	Dimensions (in)		Notch Width	Fastener Schedule		DF/SP Allowable Loads (Lbs.) <sup>1,3</sup>		S-P-F Allowable Loads (Lbs.) <sup>1,3</sup>		Code Ref.
			W	L		Qty <sup>2</sup>	Type <sup>4</sup>	Tension 100%	Compression 100%	Tension 100%	Compression 100%	
HFS24	--	14	3-5/8	24	≤ 4-1/2	24	16d	2950	2500	2537	2500	IBC, LA
HFS36	--	14	3-5/8	36	≤ 4-1/2	32	16d	4280	2500	3681	2500	LA

- 1) Allowable tension loads are for normal duration. The values may be adjusted for other durations, such as for seismic and wind loading in accordance with the AF&PA NDS.
- 2) Fastener quantity is the number of 16d common nails to be installed into each of the members to be joined. When the end distance from the joint to the first nail hole is less than 1", omit the (2) nails in the 3"ch side-plate and the (1) nail in the 1-1/2" side-plate that are nearest the joint.
- 3) There is no reduction in double top plate capacity provided the HFS24 is installed with minimum (22) 16d common nails in each member being joined (44 total) and the HFS36 is installed with (31) 16d common nails in each member (62 total).
- 4) **NAILS:** 16d nails are 0.162" dia. x 3-1/2" long.

# KRPS Repair Straps

KRPS repair straps meet IBC, IRC, & L.A. City requirements for notched plates where placed in partitions.

**Materials:** See chart

**Finish:** G90 galvanizing

**Options:** See chart for Corrosion Finish Options

**Codes:** See page 12 for Code Reference Chart

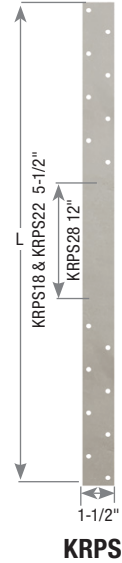
IRC R602.6.1, IBC 2308.9.8 (2015), IBC 2308.5.8 (2015)

**Installation:**

- Use all specified fasteners. See Product Notes, page 20.
- Install one strap tie for each 2x plate.



Typical KRPS installation



KRPS

MiTek USP Stock No. <sup>3</sup>	Ref. No.	Steel Gauge	Dimensions (in)		Notch Width (in)	Fastener Schedule <sup>2</sup>		DF/SP Allowable Loads (Lbs.) <sup>1</sup> Tension 160%	Corrosion Finish	Code Ref.
			W	L		Qty	Type			
KRPS18	RPS18	16	1-1/2	18-5/16	≤ 5-1/2	12	16d	1345		IBC, FL, LA
KRPS22	RPS22	16	1-1/2	22-5/16	≤ 5-1/2	12	16d	1345	Green	--
						16	16d	1790		
KRPS28	RPS28	16	1-1/2	28-5/16	≤ 12	12	16d	1345	Green	--
						16		16d		

1) Allowable loads have been increased 60% for wind or seismic loads; no further increase shall be permitted.

2) **NAILS:** 16d nails are 0.162" dia. x 3-1/2" long.

**Corrosion Finish** ■ Stainless Steel ■ Gold Coat ■ HDG ■ Triple Zinc

# STS Stud Shoes

Stud shoes reinforce joists, plates, studs, or rafters which have been drilled or notched during construction.

**Materials:** 16 gauge

**Finish:** G90 galvanizing

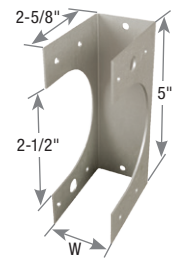
**Codes:** See page 12 for Code Reference Chart

**Installation:**

- Use all specified fasteners. See Product Notes, page 20.
- **STS units are not structurally rated and should not be used as a total member replacement in structural applications.**
- For use with 2" O.D. pipe.



Typical STS1 installation



STS

MiTek USP Stock No.	Ref. No.	Steel Gauge	Description	Dimensions (in)	Fastener Schedule <sup>1,2</sup>		Code Ref.
				W	Qty	Type	
STS1	SS1.5	18	Single Stud	1-9/16	10	10d x 1-1/2	--
STS2	SS3	18	Double Stud	3-1/16	12	10d	
STS3	SS4.5	18	Triple Stud	4-9/16	14	10d	

1) Maximum hole size = 2".

2) **NAILS:** 10d x 1-1/2 nails are 0.148" dia. x 1-1/2" long, 10d nails are 0.148" dia. x 3" long.

**O** – The O series spans three joists in under/over installation. Prong teeth in the center help reduce nailing.

**N** – The N series spans two joists per unit. Can be used for bridging or bracing I-Joists. See chart.

**Materials:** See chart

**Finish:** G90 galvanizing

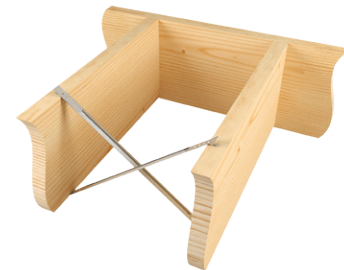
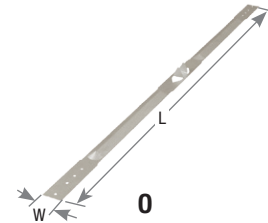
**Codes:** See page 12 for Code Reference Chart

**Installation:**

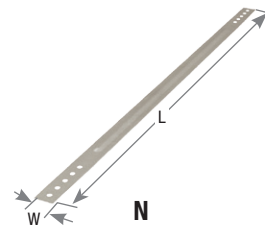
- Use specified fasteners in models with fastener requirements.
- For all models – Bridging should be installed on floor joists with a nominal depth-to-thickness ratio of 5 to 6 or more (2015 National Design Specification for Wood Construction; Section 4.4.1). Bridging units should be installed in pairs at intervals of 8' or less. Bridging pairs should form an "X" between joists; leave a slight space between the units to avoid noise-generating contact. Follow specific installation instructions below for particular models.
- Install prior to subfloor sheathing. Use (2) 8d (0.131") x 1-1/2" nails at each end. Fully seat nails to avoid any movement against the bridging and subsequent floor noise.
- Must be installed in cross pairs. Avoid bridging overlap, it may cause squeaks



Typical O installation



Typical N installation



MiTek USP Stock No.	Ref. No.	Steel Gauge	Dimensions (in)		Fastener Schedule <sup>1</sup>		Code Ref.
			W	L	Qty	Type	
N16	LTB20, TB20	22	3/4	19-3/4	4	8d x 1-1/2	IBC, FL, LA
O40	LTB40	22	3/4	39-3/4	4	8d x 1-1/2	
N27	TB27	20	3/4	26-13/16	4	8d x 1-1/2	
N30	TB30	20	3/4	29-13/16	4	8d x 1-1/2	
N36	TB36	20	3/4	35-13/16	4	8d x 1-1/2	
N42	TB42	20	3/4	42	4	8d x 1-1/2	
N48	TB48	20	3/4	48	4	8d x 1-1/2	
N54	TB54	20	3/4	54	4	8d x 1-1/2	
N56	TB56	20	1	56	4	8d x 1-1/2	
N60	TB60	20	1	60	4	8d x 1-1/2	
O16	--	18	1	44	4	8d x 1-1/2	

1) For joist spacing, refer to the Joist Installation chart.  
 2) **NAILS:** 8d x 1-1/2 nails are 0.131" dia. x 1-1/2" long.

**Joist Installations**

Joist Type	Joist Height	Joist Spacing <sup>1</sup>								
		12"	16"	19.2"	24"	30"	32"	36"	42"	48"
2x Sawn Dimensional	7-1/4	--	O40/O16/N16	N27	N27/N30	N36	N36	N42	N48	N54/N56
	9-1/4	N16	O40/O16/N16	N27	N30	N36	N36	N42	N48	N54/N56
	9-1/2	O40/O16/N16	O40	N27	N30	N36	N36	N42	N48	N54/N56
1-3/4" SCL	10	N16	N16	N27	N30	N36	N36	N42	N48	N54/N56
	11-1/4	N16	N16	N27	N30	N36	N36	N42	N48	N54/N56
	11-7/8	N16	N27	N27/N30	N30	N36	N36	N42	N48	N54/N56
	12	N27	N27	N27/N30	N30	N36	N42	N42	N48	N54/N56
I-Joists: 2-1/2" & 3-1/2" wide	14	N16	N16	N16	N27/N30	N36	N36	N36	N42	N56
	16	N16	N16	N27	N30	N36	N36	N42	N48	N56
	18	N16	N16	N27	N30	N36	N36	N42	N48	N54/N56
	20	N16	N27	N27/N30	N30	N36	N36	N42	N48	N54/N56
	22	N27	N27	N30	N30	N36	N36	N42	N48	N54/N56
	24	N27	N30	N30	N36	N36	N42	N42	N48	N54/N56
	26	N30	N30	N30	N36	N42	N42	N42	N48	N54/N56/N60
	28	N30	N30	N36	N36	N42	N42	N48	N56	N56/N60

1) Gray shaded cells represent bridging installed on the face of the joist; web stiffeners required for I-Joists.  
 2) All bridging products require (2) 8d x 1-1/2 nails at each end, which are 0.131" dia. x 1-1/2" long.

**MBG** – Grip tooth bridging. Features special teeth which grip joists and provide easy single-nail installation. Can be installed after subfloor is in place.

**MB16** – Snap-on, no-nail bridging can be placed in existing floor systems where joist movement is suspected. Two-piece construction creates a solid diagonal brace against joist movement.

**Materials:** See chart

**Finish:** G90 galvanizing

**Codes:** See page 12 for Code Reference Chart

**Installation:**

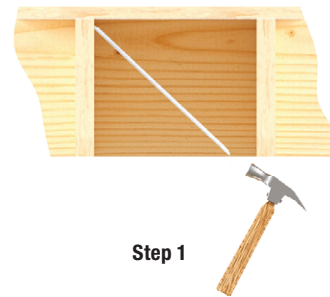
- Use specified fasteners in models with fastener requirements.
- For all models – Bridging should be installed on floor joists with a nominal depth-to-thickness ratio of 5 to 6 or more (2015 National Design Specification for Wood Construction; Section 4.4.1). Bridging units should be installed in pairs at intervals of 8' or less. Bridging pairs should form an "X" between joists; leave a slight space between the units to avoid noise-generating contact. Follow specific installation instructions below for particular models.
- **MBG** – May be installed before or after sheathing. Position the unbent end of the bridging unit near the top of the joist and drive prongs into wood with a hammer blow to the heel of the bent end. Wedge bent end near the lower edge of the opposite joist, set teeth into wood with hammer blow. Nail holes are provided at the bent end if prongs are damaged during installation. Fully seat nails to avoid any movement against the bridging and subsequent floor noise.
- **MB16** – Two-piece unit is shipped as one piece. Bend unit in center up and down to break into two pieces. Slide narrower piece inside wider piece, setting the end tab into slot appropriate for joist spacing. Setting one prong end near the top of one joist and the opposite prong end near the bottom of the opposite joist, pull down on the center of the bridging until the wider piece snaps into place over the narrow piece and creates a rigid, one-piece bridging unit. Wear gloves during installation.



**MB16**



**Typical MB16 installation**



**Step 1**



**Step 2**

**Typical MBG installation**

General Hardware

Joist Size	Joist Spacing O.C. (in) <sup>1</sup>	MiTek USP Stock No.	Ref. No.	Steel Gauge	Dimensions (in)		Fastener Schedule <sup>2</sup>		Code Ref.
					W	L	Qty	Type	
2 x 8	12	MBG812	NCA2X8-12	22	15/16	11-3/4	1	8d x 1-1/2	IBC, FL, LA
2 x 10	12	MBG1012	NCA2X10-12	22	15/16	12-3/4	1	8d x 1-1/2	
2 x 12	12	MBG1212	NCA2X12-12	22	15/16	14	1	8d x 1-1/2	
2 x 14	12	MBG1412	--	22	15/16	16	1	8d x 1-1/2	
2 x 16	12	MBG1612	--	22	15/16	17	1	8d x 1-1/2	
2 x 8-10-12	16	MB16	--	22	11/16	--	--	--	
2 x 8	16	MBG816	NCA2X8-16	22	15/16	15-9/16	1	8d x 1-1/2	
2 x 10	16	MBG1016	NCA2X10-16	22	15/16	16-5/16	1	8d x 1-1/2	
2 x 12	16	MBG1216	NCA2X12-16	22	15/16	17-1/4	1	8d x 1-1/2	
2 x 14	16	MBG1416	--	22	15/16	18-7/16	1	8d x 1-1/2	
2 x 16	16	MBG1616	--	22	15/16	19-5/8	1	8d x 1-1/2	
2 x 8	24	MBG824	--	22	1-5/16	23-1/2	1	8d x 1-1/2	
2 x 10	24	MBG1024	--	22	1-5/16	24	1	8d x 1-1/2	
2 x 12	24	MBG1224	--	22	1-5/16	24-3/4	1	8d x 1-1/2	
2 x 14	24	MBG1424	--	22	1-5/16	25-5/8	1	8d x 1-1/2	
2 x 16	24	MBG1624	--	22	15/16	26-5/8	1	8d x 1-1/2	



**MBG**

Copyright © 2019 MiTek Industries, Inc. All Rights Reserved

1) Joist spacing is based on a 1-1/2" joist, consult MiTek regarding wider joist applications.

2) **NAILS:** 8d x 1-1/2 nails are 0.131" dia. x 1-1/2" long.

Wall bracing products are engineered to meet the prescriptive 1x4 let-in brace code requirements.

**RWB** – Flat bracing conveniently packaged in a handy roll out dispenser. Perfect for unexpected job site shortages. The 35-pound dispenser pack fits easily into a truck bed for transport. Pre-embossed snap-off points can be broken off by hand (wear gloves for safety).

**WB** – A flat style bracing engineered to easily nail to studs. No cutting or fitting needed.

**WBC** – L-shaped design for additional strength and rigidity.

**WBT** – Rolled edges and T-style design gives the WBT strength, rigidity, and eliminates sharp, sheared edges.

**Materials:** See chart

**Finish:** G90 galvanizing

**Codes:** See page 12 for Code Reference Chart

**Installation:**

- Use all specified fasteners. See Product Notes, page 20.
- Bracing is a framing aid, not a substitute for structural shear wall components.
- **RWB / WB** – Use with 16" or 24" o.c. studs. Install in pairs forming an "X" or opposing "V" at each end of a maximum 25-foot long wall panel.

**Steps:** Square the panel. Straighten any kinks in bracing caused by handling. Lay bracing on the panel flush to the top of top plate and flush to the bottom of the bottom plate. Secure bracing to the top plate and bottom plate using 16d nails (WB) or 8d nails (RWB). Position second bracing at an angle opposite to the first brace to form an "X" and secure to top and bottom plate as with the first bracing. Using 8d nails, secure bracing to all intersecting studs.

- **WBC / WBT** – Use with 16" o.c. studs. Install one brace at each end of wall section, not exceeding 25 feet, in an opposing "V" pattern. Use the web portion of a length of bracing as a straight edge to mark studs. Cut a saw kerf 5/8" deep (1" deep for WBC). Insert the bracing web into the saw kerf, and drive one nail into the top plate. Raise the wall section into place and plumb. Finish fastening according to the nail schedule.



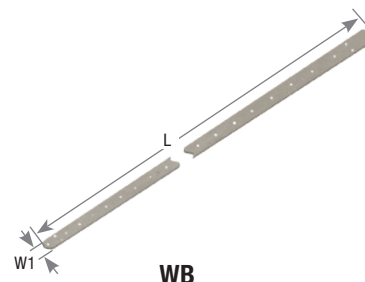
Typical RWB/WB installation



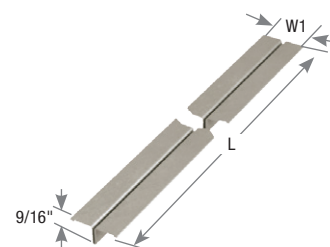
Typical WBC/WBT installation



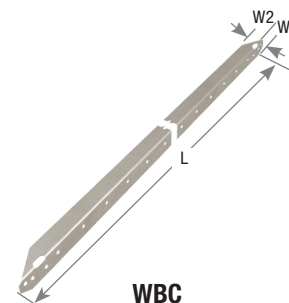
RWB pre-embossed snap-off points



WB



WBT



WBC

MiTek USP Stock No. <sup>1</sup>	Ref. No.	Steel Gauge	Dimensions (in)			Pieces Per Roll	Wall Height (ft)	Install Angle	Fastener Schedule <sup>2</sup>				Code Ref.
			W1	W2	L				Each Plate		Each Stud		
									Qty	Type	Qty	Type	
RWB96	WB106C	16	1-1/4	--	9' 6"	15	8'	60°	4	8d	1	8d	IBC, FL, LA
RWB114	WB126C	16	1-1/4	--	11' 4-3/8"	12	8'	45°	4	8d	1	8d	
RWB143	WB143C	16	1-1/4	--	14' 3"	10	10'	45°	4	8d	1	8d	
WBC10	RCWB10	18	7/8	1	9' 5-3/4"	--	8'	60°	2	16d	1	8d	
WBC12	RCWB12	18	7/8	1	11' 4-3/8"	--	8'	45°	2	16d	1	8d	
WBT10	TWB10	22	1-3/8	--	9' 3"	--	8'	60°	4	8d	1	8d	
WBT12	TWB12	22	1-3/8	--	11' 4"	--	8'	45°	2	8d	1	8d	
WBT14	RCWB14, TWB14	22	1-3/8	--	14' 2"	--	10'	45°	2	8d	1	8d	
WB106	WB106	16	1-1/4	--	9' 5-1/2"	--	8'	60°	3	16d	1	8d	
WB126	WB126	16	1-1/4	--	11' 4-1/4"	--	8'	45°	3	16d	1	8d	

1) These products substitute for code prescribed 1 x 4 let-in bracing.

2) **NAILS:** 8d nails are 0.131" dia. x 2-1/2" long, 16d nails are 0.162" dia. x 3-1/2" long.



# SB Shelf Brackets

This shelf bracket combines shelving capabilities and closet rod support in a one-piece design.

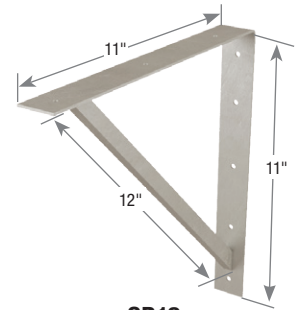
**Materials:** 13 gauge

**Finish:** Zinc Plated

**Codes:** See page 12 for Code Reference Chart



Typical SB12 installation



SB12

MiTek USP Stock No.	Ref. No.	Steel Gauge	Fastener Schedule <sup>1</sup>		Code Ref.
			Qty	Type	
SB12	SBV	13	8	10d	--

1) **NAILS:** 10d nails are 0.148" dia. x 3" long.

# KSCT Corner Tie

The Corner Tie secures three-way wood-to-wood connections. Handy for building workbenches, utility tables, or shelving using 2x4 lumber.

**Materials:** 14 gauge

**Finish:** G90 galvanizing

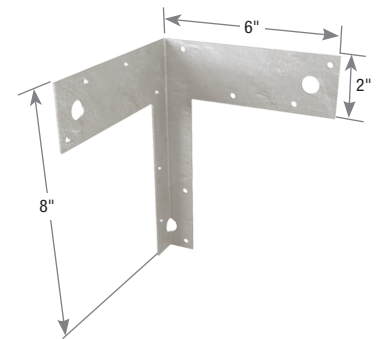
**Codes:** See page 12 for Code Reference Chart

**Installation:**

- Use (12) #10 panhead screws to fasten the KSCT68 to wood framing.



Typical KSCT68 installation



KSCT68

MiTek USP Stock No.	Ref. No.	Steel Gauge	Fastener Schedule		Code Ref.
			Qty	Screws	
KSCT68	--	14	12	#10 panhead	--

# WT Wall Tie

**Materials:** 22 gauge

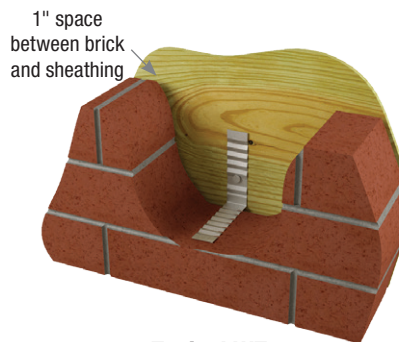
**Finish:** G90 galvanizing

**Options:** See chart for Corrosion Finish Options

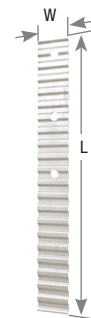
**Codes:** See page 12 for Code Reference Chart

**Installation:**

- Use nails appropriate for intended use. See Product Notes, page 20.
- The opposite end must be bonded in the mortar joint of brick facade.
- Check local codes for spacing requirements.
- Wall tie shall be bent at nail, bonding into mortar joint.



Typical WT22 installation



WT22

MiTek USP Stock No.	Ref. No.	Description	Steel Gauge	Dimensions (in)		Fastener Schedule <sup>1</sup>		Corrosion Finish	Code Ref.
				W	L	Qty	Type		
WT22	BTB	Straight Edge - Duplex	22	7/8	6-1/2	1	10d		--

1) **NAILS:** 10d nails are 0.148" dia. x 3" long.

**Corrosion Finish** ■ Stainless Steel ■ Gold Coat ■ HDG ■ Triple Zinc

# NP Nail Plates

The NP Nail Plates are an ideal economical solution for attaching wooden members together in a non-structural connection. Also may be used as a prescriptive top plate splice per the 2015 International Residential Code (IRC). They are pre-punched for 8d common nails.

**Materials:** 20 gauge

**Finish:** G90 galvanizing

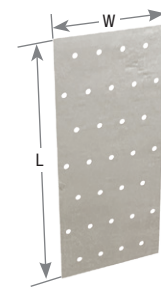
**Codes:** See page 12 for Code Reference Chart,  
IRC R602.3.2

**Installation:**

- Use nails appropriate for intended use. Holes are sized for 8d common (0.131" dia. x 2-1/2" long) or 8d (0.131" dia.) x 1-1/2" nails.
- The designer shall determine appropriate load values.

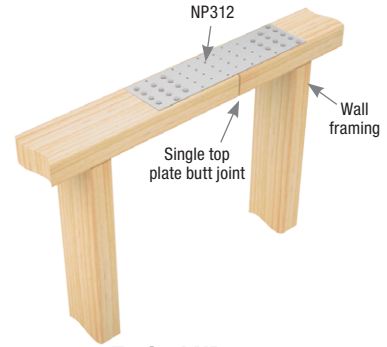


**Typical nail plate installation**



**NP**

MiTek USP Stock No.	Ref. No.	Steel Gauge	Dimensions (in)		Number of Nail Holes	Code Ref.
			W	L		
NP15	TP15	20	1-13/16	5	12	--
NP35	TP35	20	3-1/8	5	22	
NP37	TP37	20	3-1/8	7	31	
NP39	TP39	20	3-1/8	9	40	
NP311	TP311	20	3-1/8	11	49	
NP312	--	20	3-1/8	12	54	
NP315	--	20	3-1/8	15	67	
NP45	TP45	20	4-1/8	5	30	
NP47	TP47	20	4-1/8	7	42	
NP49	TP49	20	4-1/8	9	54	
NP411	TP411	20	4-1/8	11	66	
NP57	TP57	20	5-3/4	7	59	



**Typical NP312 IRC prescriptive top plate splice installation**

General Hardware

# JNP / TPP Mending Plates

**TPP** – Prong plates with straight prongs.

**JNP** – Prong plates with angled, hammer-in prongs.

**Materials:** See chart

**Finish:** G90 galvanizing

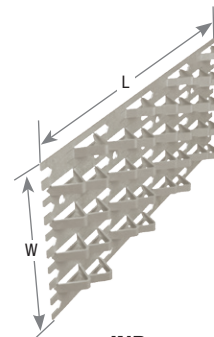
**Codes:** See page 12 for Code Reference Chart

**Installation:**

- **These products are not intended for structural use. No load ratings are assigned. These plates are not intended for use in truss assembly.**

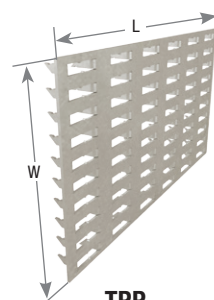


**Typical mending plate installation**



**JNP**

MiTek USP Stock No.	Ref. No.	Steel Gauge	Dimensions (in)		Code Ref.
			W	L	
JNP24	--	18	1-1/2	4	--
JNP26	--	18	1-1/2	6	
JNP46	--	18	3-3/16	6	
JNP48	--	18	3-3/16	8	
TPP14	MP14	22	13/16	3-1/2	
TPP24	MP24	22	1-11/16	3-1/2	
TPP36	MP36	22	2-3/4	5-1/4	
TPP58	--	22	4-3/16	7-13/16	



**TPP**

The information listed only applies to hangers manufactured by MiTek® and installed according to the instructions listed in this catalog. Some of the options listed may not have been evaluated on a single hanger. The designer must always evaluate each connection, including the joist and header capacities, before specifying a specialty connector. MiTek sloped hangers are manufactured with the plumb cut of the joist already calculated. If a hanger with a different height is needed, it must be specified at the time of ordering.

**Materials:** Steel gauge may vary from that specified depending on the specialty option and manufacturing process used. Some formed hangers may be welded when modifying the hanger. Hanger configurations, fastener schedules, and height may vary from the tables depending on the joist size, skew, and slope.

**Finish:** See specific hanger option tables. Welded hangers are painted with gray primer. Non-catalog hangers available in Hot-dip galvanized, use HDG after product number.

**Allowable Loads:** For multiple options for the same connector, use the most conservative reduction to give the lowest design load. See specific hanger option tables for applicable load reductions and maximum tolerances. Reference Specialty Options Summary Table for MiTek USP series catalog references.

**Installation:**

- Fill all nail holes with fasteners specified in the tables.
- Fastener quantities may increase from the amount listed in the tables depending on hanger option.
- NA16D-RS and NA20D nails are supplied with hangers.
- For type A skewed hangers, the end of joist must be bevel cut; for type B skewed hangers, the end of joist must be square cut.

**Codes:** Modified hangers are not code evaluated due to their numerous variations.

**Specialty Options Summary Table**

MiTek USP Series	Width	Skewed (Maximum)	Sloped Seat (Maximum)	Sloped / Skewed	Sloped Top Flange (Maximum)	Top Flange Offset	Saddle Hanger	Ridge Hanger (Maximum)	Inverted Flange	Uplift	Weldability	MiTek Series Catalog Page Reference
BPH	all	50°	45°	•	45°					•	•	196
FWH	all	70°								•	•	161
GHF	all	50°	45°	•					• width > 4-1/2"	•		212
HBPH	all	50°	45°	•	45°					•	•	196
HD <sup>1,2</sup>	1-3/4" or less	67-1/2"	45°	•					• width > 2-1/4"			125, 186
	> 1-3/4"	50°										
HDO	1-3/4" or less	67-1/2"	45°	•					• width > 3-1/8"			155
	> 1-3/4"	50°										
HGU	all	45°							• one flange width > 5-1/4"	•		210
HGUM									• one flange			174
HJC	all	60°								•		251
HLBH	all	50°	45°	•	45°	•	•	45°			•	197
HUS	all								• width > 2-1/4"	•		124
IHFL/IHF	1-3/4" or less	67-1/2"	45°	•					• width > 2-1/4"			185
	> 1-3/4"	50°										
HWUH	all	45°	45°	•		•	•			•		176
KB	all									•	•	155
KEG	all	45°	45°							•		213
KGB	all									•	•	214
KGH	all	45°					•					61
KGLS	all	50°	45°	•	30°	•	•			•	•	218
KGLST	all						•			•	•	218
KGLT	all	50°	45°	•	45°	•	•			•	•	215
KHGB	all									•	•	214
KHGLS	all	50°	45°	•	30°	•	•			•	•	218
KHGLST	all						•			•	•	218
KHGLT	all	50°	45°	•	45°	•	•			•	•	215
KHHB	all									•	•	214
KHW	all	84°	45°	•	35°	•	•	45°			•	156
KLB	all										•	155
KLEG	all	45°	45°			•				•		213
KMEG	all	45°	45°			•				•		213
LGU	all	45°							• one flange width > 3-5/8"	•		210
LSSH	all	45°	45°	•						•		165
MGU	all	45°							• one flange width > 5-1/4"	•		210
MPH <sup>1</sup>	all	60°	45°	•		•						178
MSHA	all	75°								•		248
MSHL/R	all	45°								•		246
NFM	all	45°								•		180
PHM	all	84°	45°	•	35°	•	•	45°			•	198
PHXU <sup>1</sup>	all	60°	45°	•	35°	•	•			•	•	198
SKH	all	45°								•		166
SKHH	all	45°								•		166
SUH	1-3/4" or less	67-1/2"	45°	•								123
	> 1-3/4"	50°										
SW <sup>1</sup>	all	84°	45°	•	35°	•	•	45°			•	156
SWH <sup>1</sup>	all	84°	45°	•	35°	•	•	45°			•	156
THD	all	45°	45°	•					• one flange width > 3"	•		239
THDH	all	45°	45°	•						•		241
THF	> 1-3/4"	50°	45°	•					• width > 2-1/4"	•		186

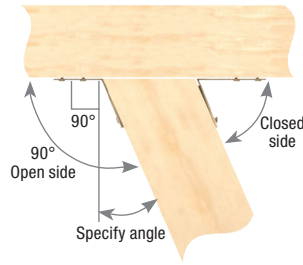
1) Skews greater than 45° will have square cut joist with back plate. Refer to Typical HLBH hanger skewed, left shown, square cut illustration on page 285.  
 2) HD hanger widths less than 2-1/4" may have flanges inverted as a Custom, contact MiTek. New products or updated product information are designated in blue font.

# Face Mount Hanger Specialty Details

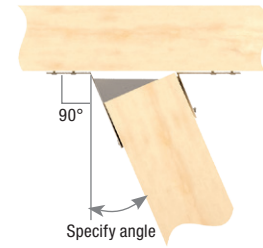
See the Specialty Options Chart for each hanger series for load reductions and hanger maximum range of skew, slope, etc.

**Skewed Hanger:**

- Consider SKH or SKHH hangers for 45° skews.
- Joist nails on the closed side may be relocated to the open side by MiTek designer to ensure proper nailing.
- Specify skew angle, type (square cut or bevel cut), and direction when ordering.



**Typical SUH hanger skewed, right shown (bevel cut)**



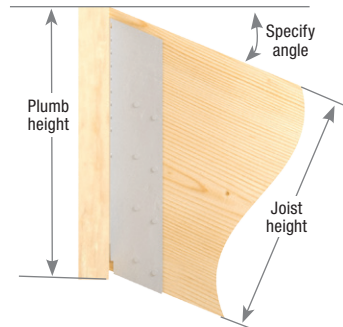
**Typical SUH formed hanger skewed, right shown (square cut)**

**Sloped Seat Hanger:**

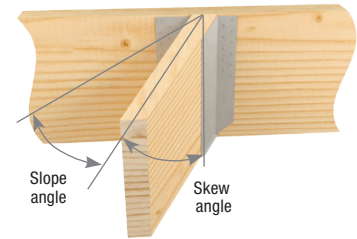
- Consider LSSH series for sloped applications.
- Additional nail holes may be added to joist flanges.
- Specify slope angle and direction when ordering.

**Sloped/Skewed Hanger:**

- See nailing notes above for both Skewed Hanger and Sloped Seat Hanger.
- Specify skew and slope angles as well as skew/slope directions and skew type (square cut or bevel cut) when ordering.



**Typical HD hanger sloped seat, down shown**



**Typical HD hanger sloped down, skewed left shown**

**Inverted Flange Hanger:**

- When fastening into the carrying member's end grain, the allowable load is 0.65 of the table load.
- Hangers with one flange inverted achieve 100% of listed table load.
- Specify right or left flange when inverting only one flange.

Refer to GHF, HD, SUH, THD, THDH, THF series Special Order Worksheet for ordering instructions at MiTek-US.com.



**Typical GHF hanger one flange inverted, left shown**



**Typical HD hanger inverted flange**

# Open Top Flange Hanger Specialty Details

See Specialty Options Chart for each hanger series for load reductions and hanger maximum range of skew, slope, etc.

**Skewed Hanger:**

- Joist nails may be located on obtuse angle side by MiTek designer to ensure proper nailing.
- Specify skew angle, type (square cut or bevel cut), and direction when ordering.

**Sloped Seat Hanger:**

- Additional nail holes may be added to joist flanges by MiTek designer. All fastener holes must be filled.
- Specify slope angle, direction, and joist height when ordering.

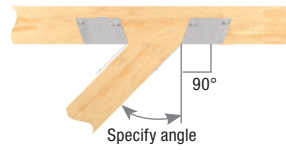
**Sloped/Skewed Hanger:**

- See nailing notes above for both Skewed Hanger and Sloped Seat Hanger.
- Specify skew and slope angles as well as skew/slope directions, and skew type (square cut or bevel cut) when ordering.
- Similar to face mount skewed/sloped hanger, refer to illustration on page 284: Typical HD hanger sloped down, skewed left shown.
- Specify if hanger is to be high side flush, low side flush, or center flush.

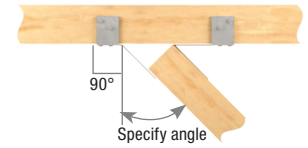
**Sloped/Skewed/Sloped Top Flange Hanger:**

- See nailing notes for both skewed and sloped hangers.
- Specify skew, slope, and top flange slope angles as well as skew/slope and top flange slope directions when ordering.
- Hangers may be galvanized or painted.
- Hangers may be made with solid top plate.

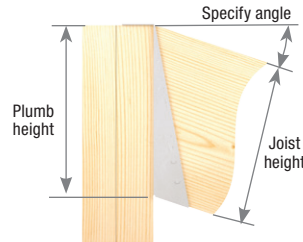
Refer to BPH series Special Order Worksheet for ordering instructions at MiTek-US.com.



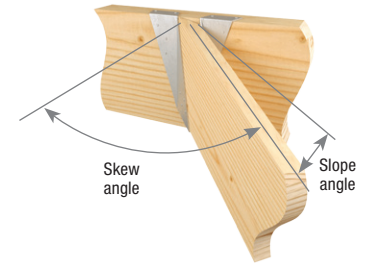
**Typical BPH hanger skewed, left shown**  
(bevel cut)



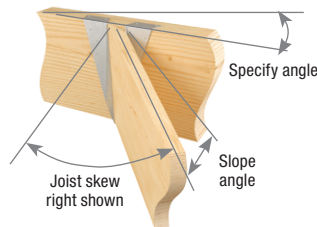
**Typical HDO hanger skewed, right shown**  
(square cut)



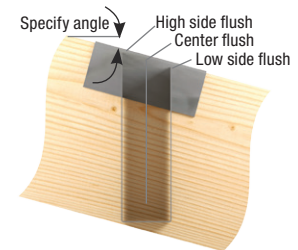
**Typical BPH hanger sloped seat, down shown**



**Typical BPH hanger sloped down, skewed right, low side flush shown**



**Typical BPH hanger skewed right, sloped down, top flange sloped**



**Typical BPH hanger sloped top flange right shown**  
(this configuration will not be open back)

# Solid Top Flange Hanger Specialty Details

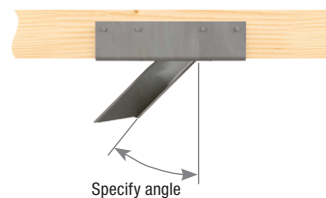
See Specialty Options Chart for each hanger series for load reductions and hanger maximum range of skew, slope, etc.

**Skewed Hanger:**

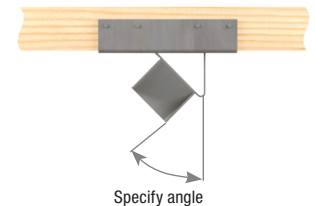
- Joist nails may be located on obtuse angle side by MiTek designer to ensure proper nailing.
- Specify skew angle, type (square cut or bevel cut), and direction when ordering.

**Sloped Seat Hanger:**

- Additional nail holes may be added to joist flanges by MiTek designer.
- Specify slope angle, direction, and joist height when ordering.



**Typical HLBH hanger skewed, left shown**  
(bevel cut)

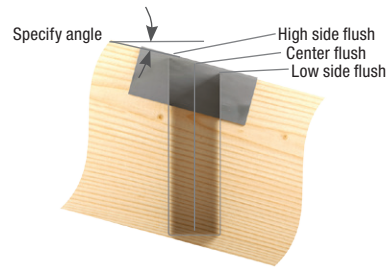


**Typical HLBH hanger skewed, left shown**  
(square cut)

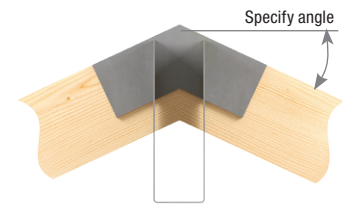
# Solid Top Flange Hanger Specialty Details

**Sloped/Skewed Hanger:**

- See nailing notes above for both Skewed Hanger and Sloped Seat Hanger.
- Specify skew and slope angles as well as skew/slope directions, and skew type (square cut or bevel cut) when ordering.
- Specify if hanger is to be high side flush, low side flush, or center flush.



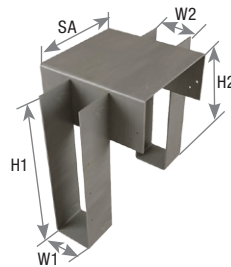
**Typical HLBH hanger sloped down top flange, right shown**



**Typical HLBH hanger ridge, top flange slope**

**Sloped Top Flange Hanger:**

- Additional nail holes may be added to top angle by MiTek designer.
- Specify top flange slope and direction when ordering.
- Specify if hanger is to be high side flush, low side flush, or center flush.



**Typical PHXU hanger saddle option**



**Typical HLBH hanger top flange offset, right shown**

**Ridge Hanger:**

- Specify flush top of beam at center, right side, or left side.
- Specify angle of slope when ordering.

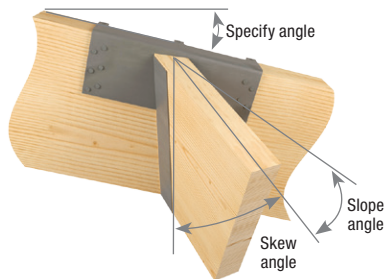
**Top Flange Offset Hanger:**

- Specify offset, left (L) or right (R), when ordering.

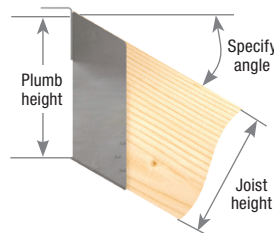
**Saddle Hanger:**

- Specify saddle width, "SA" when ordering. Allow clearance for saddled member.

Refer to options for HLBH, KGLS, KGLT, KHGLS, KHGLT series or HWUH, KHW, PHM, PHXU, SW, SWH series Special Order Worksheet for ordering instructions at MiTek-US.com.



**Typical HLBH hanger skewed right, sloped down right, top flange sloped**



**Typical HLBH hanger sloped seat, down shown**



**Typical HLBH hanger sloped down, skewed right, center flush shown**

# Welded Top Flange

- Weld sizes and lengths shown on chart.
- Weld-on applications produce maximum allowable load listed.  
**Uplift loads do not apply to this application.**

### Top Angle Weld Length Chart

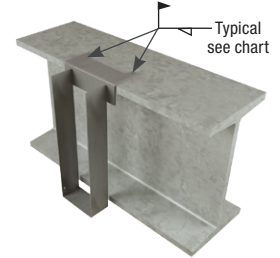
MiTek USP Welded Hanger Series	Weld Length
SW	3"
BPH, FWH, HBPH, PHM, SWH	4"
KLB, KHW, PHXU	6"
KB, KGB, KHGB, KHHB, KGLS, KGLST, KGLT, KHGLS, KHGLST	8"
HLBH, KHGLT	10"

Top Angle Steel Gauge	Weld Size
14 - 10 gauge	1/8"
7 gauge	3/16"
3 gauge	1/4"

Weld shall be distributed evenly.



Typical top flange welded installation



Typical top angle welded installation

## Part Number System

Part Numbers assigned to TFL, THO, IHFL, IHF, THFI and THF I-Joist hangers reveal the I-Joist sizes to be used with the specific hanger. This guide will teach you how to recognize I-Joist dimensions in the part numbers.

1st, 3rd, and sometimes 4th digits are whole numbers  
(This example denotes 2 and 11)  
4th digit may be part of a decimal –



2nd and 5th digits are decimals  
(see guide below)  
(This example denotes .3125  
[5/16] and .875 [7/8])  
5th digit may be (0) or dropped if height is even

#### Part Number Guide for Decimals

1 = .125	or	1/8 inch
2 or 25 = .25	or	1/4 inch
3 = .3125	or	5/16 inch
5 = .5	or	1/2 inch
6 = .625	or	5/8 inch
7 = .75	or	3/4 inch
8 = .875	or	7/8 inch

# THO35925-2

**THO**  
Letters refer to Hanger Series  
ex.: THO

**35**  
First (2) Digits refer to Member Width  
ex.: 3.5 inches

**925**  
Last (2) or (3) Digits refer to Member Height  
ex.: 9.25 inches

**-2**  
Digits after Dash refer to Number of Plies  
ex.: 2-ply

#### Some Examples:

- THO15950 ..... 1-1/2" x 9-1/2"
- IHFL17925..... 1-3/4" x 9-1/4"
- THO16925-2 ..... double 1-5/8" x 9-1/4"
- THF23925-2..... double 2-5/16" x 9-1/4"

**Note:** MiTek's USP Product Catalog lists a range of heights for IHFL/IHF hangers. Face mount hangers can usually accommodate more than one I-Joist height. The hanger height must be tall enough to support the top chord of the I-Joist to eliminate web stiffener requirements for lateral stability. The IHFL/IHF hanger must be a minimum of 60% of the joist height.

## Hardy Frame® Code Evaluation

ICC-Evaluation Service ESR-2089

Hardy Frames has been leading the pre-manufactured shear wall industry from its beginning. Hardy Frames were the first to be recognized by ICBO-ES and LA City, first to gain approval for multi-story applications, first Balloon Wall application and first to be recognized to comply with the 2003 and 2006 IBC and IRC Building Codes. Today we are the first and only to offer a 9" Panel width and a Balloon Wall application that is fully assembled in the manufacturing plant and ships as a one piece unit.

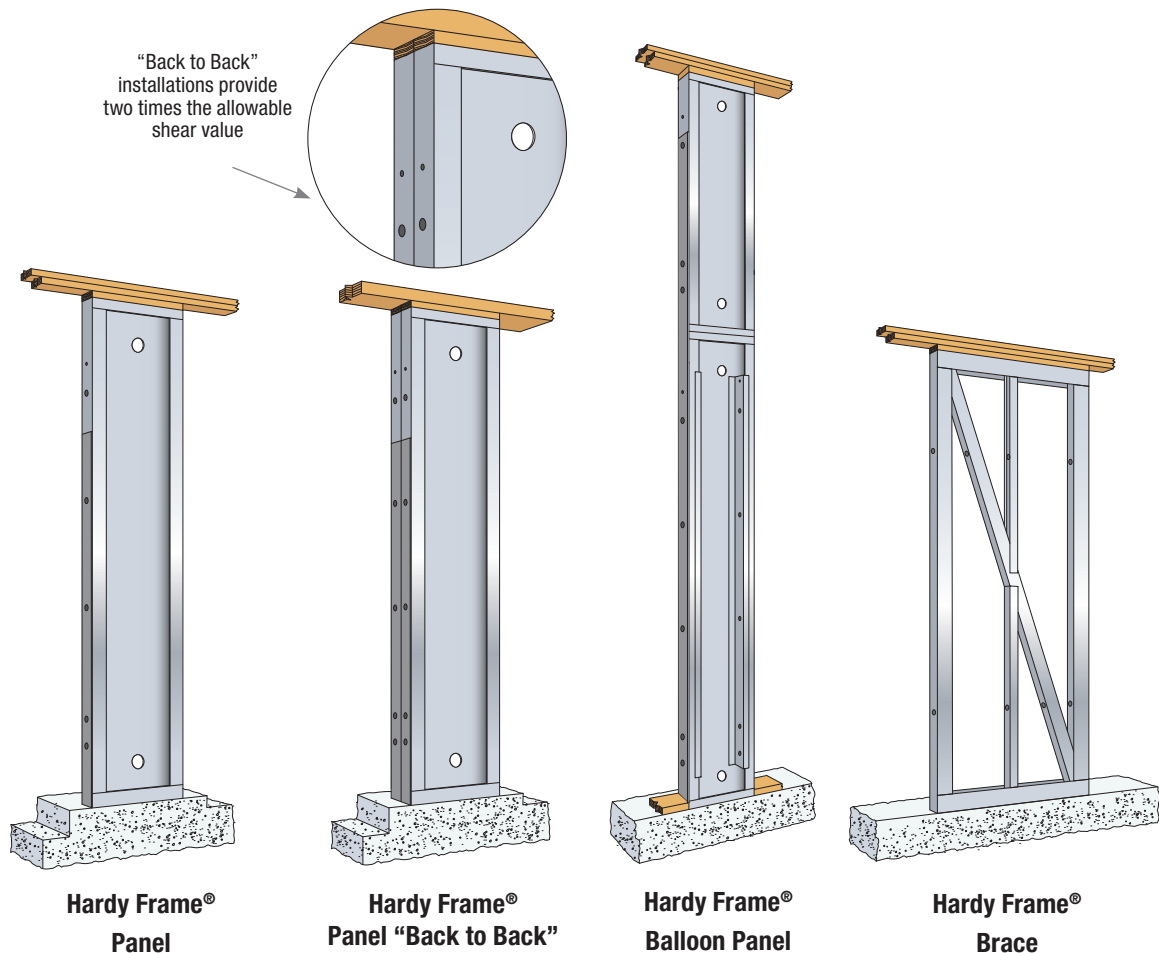
All Hardy Frame® Shear Walls are code listed and include installations on concrete, raised floor and upper floor systems.

## Hardy Frame® Panels

- Panels are available in 9, 12, 15, 18, 21 and 24" widths
- Standard Heights range from 78" for portal applications to 20' for Balloon Walls
- Custom heights are manufactured routinely
- R Value for design = 6.5, Cd = 4.0
- "Back to Back" installations provide two times the allowable shear value without increasing the wall length

## Hardy Frame® Brace

- Available in 32 and 44" widths
- Standard Heights range from nominal 8 to 13 feet
- Custom heights are manufactured routinely
- R Value for design = 6.5, Cd = 4.0
- For a given shear load, installing a wider shear wall results in reduced overturning





MiTek Hardy Frame® Special Moment Frames are constructed of wide flange columns connected to hollow structural steel (HSS) beams with SidePlate special moment connections.

The SidePlate special moment connection is approved in the AISC 358 Prequalified Moment Connections Standard and the review included testing that confirmed lateral bracing to prevent twist and out-of-plane displacements is not required at the hollow structural section (HSS) beams. Standard configurations are the Hardy Frame® Moment Frame with a pinned base and the Hardy Frame® Picture Frame.

## Hardy Frame® Moment Frame

- Standard designs for nominal 6" through 14" column depths with pinned base anchorage are now available
- Delivery options for pre-assembled, bolted column splice or "knock-down"
- All standard designs fit in typical 8" wall framing, 6" column depths fit 6" framing
- New construction and retrofit applications
- Includes wood nailers at top & bottom of HSS beam and at all column flanges

## Hardy Frame® Picture Frame

- Constructed with HSS beams at top and bottom of Frame, SidePlate special moment connections at all four corners
- HSS beam at bottom of Frame eliminates the engineering and field construction of costly grade beams
- Significant reductions in installation time result from elimination of field built grade beam
- Standard designs for nominal 6" through 14" column depths that fit into typical wall framing with double the capacity of our pinned base option are now available
- All the same delivery options and wood nailer inclusions as the Hardy Frame® Moment Frame with pinned base



## The First and Only Cold Formed Steel (CFS) Moment Frames

The all new MiTek Hardy Frame® CFS Moment Frame and CFS Picture Frame are the industries first standardized, pre-engineered, pre-manufactured cold formed steel moment frames.

Lighter and less cost than structural steel moment frames, our CFS product line provides high capacities, ductility and cost economics that complete a spectrum of MiTek shear wall solutions.

Standard configurations are the Hardy Frame® CFS Moment Frame (portal applications) and the Hardy Frame CFS Picture Frame for stacking in multi-story applications.

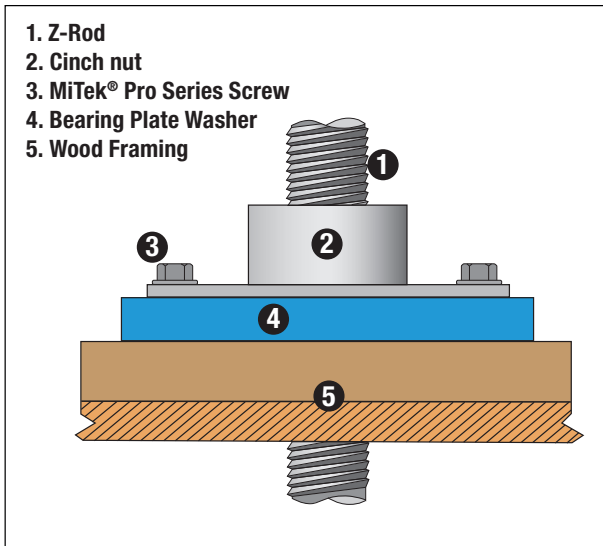
## Hardy Frame® CFS Moment Frame

- Similar materials and installation as Hardy Frame Panels the industry leader for 20 years
- Available in standard designs and standard detailing
- Capacities that are equal to four or five Hardy Frame Panels of same width
- Can be installed "Back to Back" to double the capacity

## Hardy Frame® CFS Picture Frame

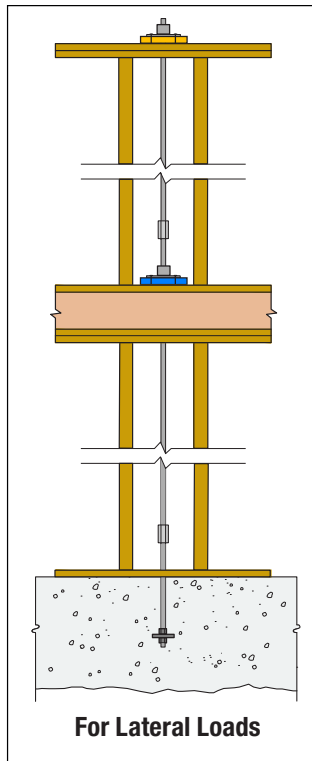
- Second beam that assembles at the bottom of the Frame distributes compression over wood below to significantly reduce crushing and maintain shear capacity
- Incorporates the MiTek Z4 Continuous Tie-Down System to transfer overturning and uplift forces to the foundation
- Narrow columns (12 through 21") and shallow beam depths (12 and 15") enable large openings and architectural freedom
- Ships as a "knock-down" unit: easy to handle, ship and field assemble





## MiTek® Z4 Tie-Down System for Lateral Load

To resist tension loads due to overturning moments in multi-story buildings the CNX Cinch Nut is installed over a Bearing Plate Washer at each level in a fast and easy application. At the upper-most level a Cinch Nut is installed over a Bearing Plate Washer above the top plates. At walls below that bear on wood floor systems, the Cinch Nut and Bearing Plate Washer are installed over the bottom plate. Tension loads are gathered at each level and transferred into the foundation through a continuous system of Cinch Nuts, Bearing Plate Washers, Z-Rods/ATRs and Couplers all are available lines of **MiTek®, USA.**

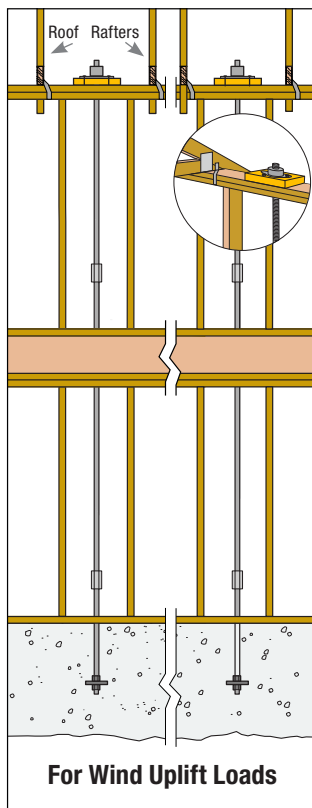


MiTek® Z4 Tie-Down Systems utilize CNX-Series Cinch Nuts to compensate for wood shrinkage and building settlement that cause connections to loosen over time. The Cinch Nut uses a self-ratcheting action that permits the cinch nut to move (the rod doesn't move) or "travel" perpetually in one direction only down the rod. Available for installation with threaded rods that are 3/8" through 1-1/2" diameter in 1/8" increments, the CNX Cinch Nut has been code evaluated and published in ESR-2190.

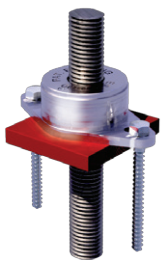
- Place the specified Bearing Plate Washer onto the bottom plate of a wood framed wall.
- With the "wings" oriented downward, place Cinch Nut over the Z-Rod extending from below and push down until it seats firmly on the Bearing Plate Washer.
- Install 1/4" diameter MiTek® Pro-Series™ Screws through the wings, penetrating 1-1/2" (minimum) into the wood bottom plate.
- Model numbers BPW5 and BPW6 fit in-between the screws fastening the wings.
- Model numbers BPW7 (3-1/4 x 4-3/8) and larger are provided with two screw holes. Align the wing and the Bearing Plate Washer screw holes to allow installation of 1/4" diameter MiTek® Pro-Series™ Screws.

## MiTek® Z4 Tie-Down System for Wind Uplift

For resisting roof uplift loads resulting from wind the Z4 Cinch Nut is installed over a Bearing Plate Washer above the top plates with roof framing above to create a tie-down system. Uplift forces are transferred into a continuous system of Z-Rods / ATRs and Couplers that form a load path to the foundation.



Lateral Systems



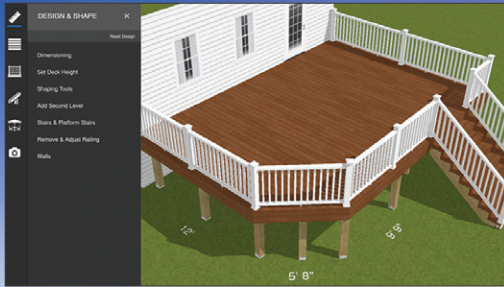
**BPW5, BPW6 Installation**



**BPW7 and larger Installation**

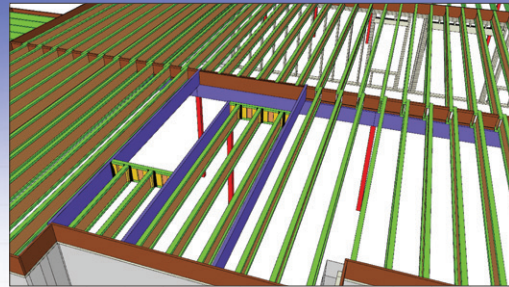
# BETTER BUILDING BEGINS WITH MITEK SOFTWARE

OUR INNOVATIVE SOFTWARE IS DESIGNED TO WORK WITH MITEK USP ENGINEERED STRUCTURAL HARDWARE.



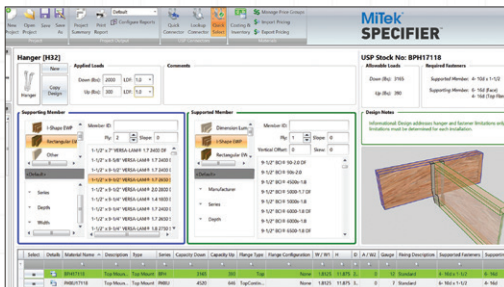
## MITEK® DECK DESIGNER™

Build, collaborate and share ideas easily with our free online software that will help you and your clients design the deck of their dreams. Deck Designer™ software is a simple point and click tool used by anyone from the homeowner to the pro deck builder. Free download at: [MiTek-US.com/software/Deck-Designer](http://MiTek-US.com/software/Deck-Designer)



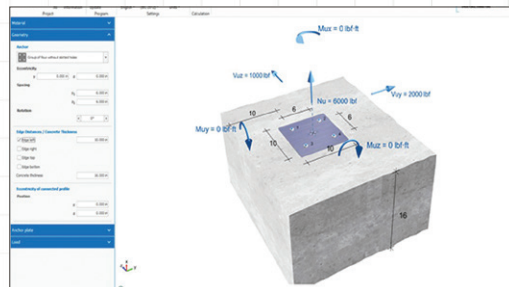
## MITEK® SAPPHIRE™ SUPPLY

Eliminate the guesswork and create take-offs that everyone agrees on. For building material dealers, SAPPHIRE™ Supply is the one-stop solution for whole-house estimating, EWP and lumber design. Now your waste factor no longer has to account for the fudge factor. Learn more at: [MiTek-US.com/software/SAPPHIRE-Supply](http://MiTek-US.com/software/SAPPHIRE-Supply)



## MITEK® SPECIFIER™

Designed for Engineers and Estimators, Specifier™ software **simplifies access to information on thousands of MiTek® USP Structural Connectors**. Looking up connector capabilities, viewing code evaluation reports and mapping from referenced products to USP products is free, quick and easy to use. Specifier™ assists with the design, specification and quoting processes for steel connections in wood frame structure of all sizes. Free download: [MiTek-US.com/software/specifier](http://MiTek-US.com/software/specifier)



## MITEK® ADHESIVE ANCHOR DESIGN

Adhesive Anchor Design is powerful design software that provides optimized epoxy connection solutions for threaded anchors post-installed into concrete. The software determines the required anchor rod steel grade, diameter and effective embedment depth based on applied factored tension, shear and moment loads. Free download: [MiTek-US.com/software/Adhesive-Anchor-Design](http://MiTek-US.com/software/Adhesive-Anchor-Design)

# MiTek®



## MADE IN AMERICA. DESIGNED TO LAST.

We are proud that our MiTek® USP® Structural Connectors are designed, manufactured or distributed in 10 strategic locations in the United States.

### WAREHOUSE & DISTRIBUTION

#### CALIFORNIA

250 Klug Circle  
Corona, California 92880  
Will Call Hours: 8:00 am to 4:30 pm PST

#### CALIFORNIA

25315 S. Schulte Road  
Tracy, California 95377  
Will Call Hours: 8:00 am to 4:00 pm PST

#### GEORGIA

4380 International Parkway, Suite A  
Hapeville, Georgia 30354  
Will Call Hours: 7:30 am to 4:00 pm EST

#### INDIANA

2363 East Perry Road  
Plainfield, Indiana 46168  
Will Call Hours: 8:00 am to 4:00 pm EST

#### NEW JERSEY

120 Hancock Drive  
Westampton, New Jersey 08060  
Will Call Hours: Mon - Thur 8:00 am to 5:00 pm,  
Friday only - 8:00 am to 4:00 pm EST

#### TEXAS

14418-A Smith Road  
Humble, Texas 77396  
Will Call Hours: 7:30 am to 4:00 pm CST

### MANUFACTURING

#### ARIZONA

7890 W. Lincoln Street  
Tolleson, Arizona 85353  
Will Call Hours: 8:00 am to 4:30 pm MST

#### FLORIDA

11910 62nd Street North  
Largo, Florida 33773  
Will Call Hours: 8:30 am to 4:30 pm EST

#### MINNESOTA

703 Rogers Drive  
Montgomery, Minnesota 56069  
Will Call Hours: 8:00 am to 4:30 pm CST

#### MISSOURI

310 James S. McDonnell Blvd.  
Hazelwood, MO 63042  
Will Call Hours: 7:00 am to 2:30 pm CST

### CUSTOMER SERVICE

Phone: 1-800-328-5934  
Fax: 952-898-8605  
Email: [uspcustomerservice@mii.com](mailto:uspcustomerservice@mii.com)  
Website: [MiTek-US.com](http://MiTek-US.com)