



BROWN JORDAN  
OUTDOOR  
KITCHENS  
CONTRACT



HOSPITALITY • CLUBS • MULTI-FAMILY • COMMERCIAL



# WHO WE ARE

Since the late 1990s, Brown Jordan Outdoor Kitchens has led the transformation of outdoor living spaces from simple barbeque islands to fully functional outdoor kitchens. Our innovative, stainless steel cabinets have pioneered outdoor entertainment, culinary creativity and leisure living, by showcasing style, design and functionality.

Once again, Brown Jordan Outdoor Kitchens leads the way with a state-of-the-art line of outdoor mobile food and beverage service carts for hospitality and multi-family properties. Designed, engineered and manufactured to meet the needs of F&B professionals as well as owners and managers representing a wide variety of properties – from wineries to resorts, casinos to clubs, and hotels of every description.

In addition to the mobile units, Brown Jordan Outdoor Kitchens offers a line of stationary cabinet products designed for multi-family properties. The Post and Panel System and the Assembled Outdoor Kitchens meet the unique needs of common area outdoor entertainment, as well as the challenges of high-rise balcony amenities.

In parallel with the growth of these specialty products, our stationary, semi-custom cabinets are finding popularity in commercial settings, such as sports areas, restaurants, in poolside cabanas, community rooms and, even, stables. Available in dozens of styles and hundreds of sizes, with a durable, beautiful and maintenance-free finish, these cabinets are perfect for the heavy traffic use of hospitality, commercial and multi-family environments.

All cabinetry is available to meet ADA-compliance regulations and has been engineered for easy installation.



All of our carts are manufactured in our Connecticut factory. Work with our in-house engineers to create a cart that suits your individual needs.

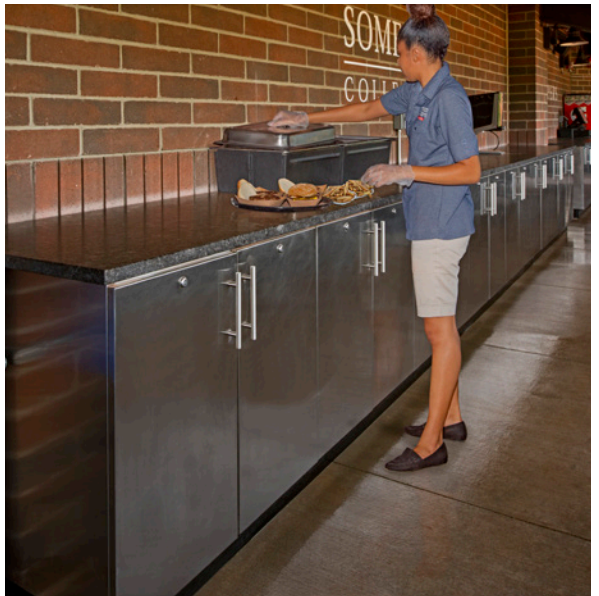

# OUTDOOR MOBILE FOOD & BEVERAGE SERVICE CARTS

Brown Jordan Outdoor Kitchens manufactures highly engineered tubular steel and aluminum outdoor mobile food and beverage service carts. Available in customizable configurations, these innovative units are designed for function, maneuverability, durability and beauty and are perfect for any hospitality or multi-family property.

Built to enhance guests' and residents' experiences, while withstanding the everyday use and abuse of hospitality and multi-family environments, these carts feature:

- **Tubular Steel Frame Construction** – Provides strength and durability
- **Powder Coated Finishes** – Provides weather resistance and protection in all climates, including ocean-side
- **Aesthetics** – Powder coated in a broad spectrum of colors, realistic wood grains, branded graphics and other options create a beautiful addition to the venue
- **Easy Storage** – Built to store anywhere without a cover
- **Dual Handles** – Allows for easy maneuverability
- **9" Semi-Pneumatic Wheels** – Enhance ease of movement on rough terrain
- **Top Lock Brakes** – Robust brakes provide stability and safety during use
- **Maneuverable Size** – Designed to navigate interior doorways and elevators
- **Customizable Configurations** – Standard frames provide for many potential uses/appliances
- **Code Compliant** – Appliances are NSF approved
- **Ready to Use** – If sold with the appliance and countertop, carts can be used upon delivery (hook up may be required)
- **Interchangeable Panels** – Easy change, lightweight aluminum panels for custom branding, event sponsorship opportunities, beauty, and durability

- **Easily Maintained** – Designed to hose down at the end of a shift (if no electrical components)
- **Multiple Locations** – Mobility provides the freedom to locate by the pool, on a rooftop, on a golf course or anywhere you want to support a gathering
- **Built-in Umbrella Mounts** – Easily add/remove umbrellas for shade



# BENEFITS

Brown Jordan Outdoor Kitchens outdoor mobile food and beverage carts offer a range of benefits to developers, hoteliers, club and property managers, regardless of venue or property. These outdoor mobile food and beverage service carts increase revenues, productivity and enhance the overall guest and resident experience. All units are designed to be maneuverable, functional and beautiful. Built to the highest standards for durability and longevity, these carts last longer than similar products, include a 5-year limited warranty, and financing is available.

- **Prepare, Sell and Serve Immediately anywhere on the property – outdoors or in**
  - Poolside
  - Golf Course
  - Concourses
  - Tennis Courts
  - Fields
  - Rooftops
- **Expand Current Facilities**
  - Satellite/Supplemental Bars when traditional bars are crowded
  - Augment catering capabilities and locations on-the-fly
  - Use spaces previously unavailable to bar carts and cooking facilities
  - Augment storage outdoors or in cabanas



- **Improved Guest Experiences**
  - Serve hot food or cold beverages at the point of sale
  - Increase menu offerings with exotic fare served from mobile stations
- **Fiscal Responsibility**
  - Increase revenue opportunities with easily interchangeable signage on the carts
  - Longevity and durability of tubular steel and aluminum cart construction means fewer replacements
  - Reduce required staff for event set-up
  - Protect from your cart from the elements with powder coat finishes
  - Practical for outdoor storage options
  - Modular construction offers part replacements, rather than whole units
  - Powder coat finishes make the carts virtually maintenance free
  - Financing opportunities allow revenues to cover expenses



# CART CONFIGURATIONS

## Configuration 01: The Open Bar

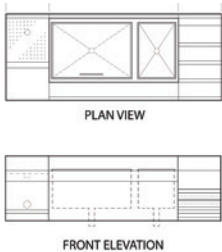

- 12" tiered liquor display
- 24" & 12" ice wells with covers
- 12" drainboard
- Blender rack
- Condiment tray

## Configuration 02: The Speciality Bar

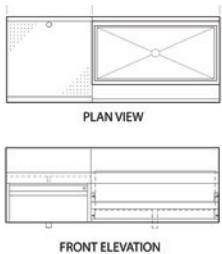

- 36" ice well with cover
- 24" drain board
- 24" lockable storage under drainboard
- 36" speedrail

## Configuration 03: The Banquet Bar

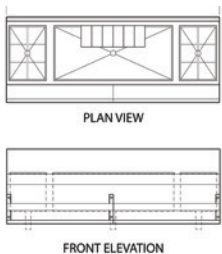

- 36" ice well with cover
- (2) 36" speed Rails
- (2) 12" ice wells
- Condiment tray



## Configuration 04: The EVO Cart

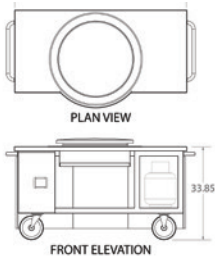

- Performance style cooking
- Variable temp. (225° – 550° F)
- NSF rated grill
- Available with locking doors
- Allows for varied menu options

## Configuration 05: The Kegerator Cart

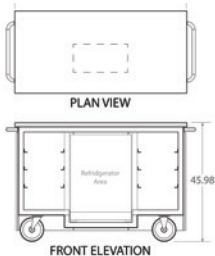

- Many tap options
- Includes glass rack brackets
- Sell ice cold keg beer anywhere.
- Can be purchased with/without kegerator

## Configuration 06: The Crown Verity Cart

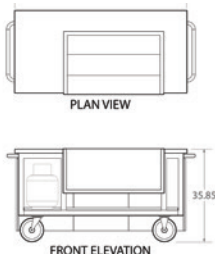

- 64,000 BTUH
- NSF rated grill
- 588 sq/in cooking surface
- 1 yr. parts and labor warranty
- Also works with other grill manufacturers

# PANEL OPTIONS

Customize your mobile food and beverage carts with removable panels.

The panels are easily removed and replaced providing ultimate flexibility to create a unique look for any event on the property. This capability opens additional revenue streams by offering custom panel graphics for sponsorships or events such as weddings or corporate clients.



**Removable Signs** – The signs can be printed at a local print shop on plexiglass or other material for event personalization, such as a wedding or for event sponsorship opportunities.



**Branded Logos** – The panels can be emblazoned with corporate brands and logos, then powder coated into the aluminum ensuring a clean consistent look.



**Powder Coated** – Select from a wide palette of colors, wood grains and environmental designs to give your carts a unique look.



# MULTI-FAMILY DEVELOPMENTS

Whether your current project is multi-family, senior living, educational, commercial or hospitality, Brown Jordan Outdoor Kitchens helps you create the perfect outdoor amenity package for the project. We understand the need for ultra durability, commercial-grade appliances, ADA-compliant cabinetry and other complexities that single family builders don't encounter, including quality and aesthetic cabinetry without storage capabilities in rental properties.

While common areas on rooftops and podiums are the norm, we are now seeing purchased units in multi-family and branded residential communities outfitted with personal outdoor amenity packages directly on individual balconies and terraces.



# ASSEMBLED OUTDOOR KITCHENS

To meet the needs of multi-family architects, designers and developers creating the ultimate outdoor space, Brown Jordan Outdoor Kitchens developed the Assembled Outdoor Kitchen (AOK) and the Post and Panel System.

The AOK is a prefabricated outdoor kitchen that can be craned to the balcony as a single piece, positioned, connected and ready to use as an entertainment space. Each AOK is configured in conjunction with the architect, designer or developer for a specific project and is built to order in multiples for individual apartments within a multi-family community. AOKs typically contain a grill (propane, gas or electric) on a grill base, a trash pull cabinet and additional storage, but can be customized with any of our cabinets or appliances, including refrigerators, bartending centers and more.

Regardless of the project, Brown Jordan Outdoor Kitchens is your multi-family partner.



# POST & PANEL SYSTEM

For Multi-family and Residential

Although our traditional cabinetry is an excellent choice for outdoor amenity packages, architects and builders expressed the need for a storage-free solution designed for multi-family common areas. Our designers and engineers listened and developed the Post and Panel System – PPS, that meets specific needs including:

- **Attractiveness and aesthetics**
- **100% stainless steel construction for durability and longevity**
- **No unnecessary storage space**
- **Extended workspaces**
- **Easily replaceable sections, in the event of damage**
- **Powder coated finishes for aesthetics and protection from the elements**
- **Easy to clean vs. conventional stone, stucco or brick**
- **Designed to reduce the growth of mold and mildew**
- **Strength to support countertops**
- **Lightweight solution for rooftops**
- **Replaceable panels with the countertop in place**
- **Shipped flat**
- **Easy installation**
- **Cost effective**
- **ADA-compliant**

Used as a stand-alone island or easily integrated with our traditional cabinet line, the PPS provides designers, architects and developers with seemingly unlimited options to choose from.

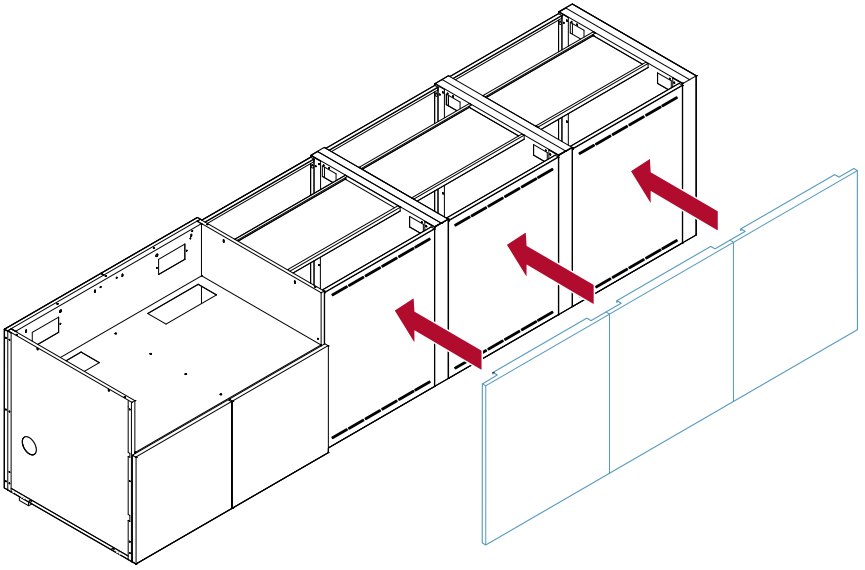



BROWN JORDAN  
OUTDOOR  
KITCHENS  
CONTRACT

## RECENT PROJECTS:

Four Seasons Atlanta, Atlanta, GA  
Four Seasons Los Angeles at Beverly Hills, Los Angeles, CA  
Palace Resorts, Cancun, Mexico  
Hyatt Regency Orange County, Garden Grove, CA  
Coronado Resort, San Diego, CA  
Mizner Country Club, Delray Beach, FL  
Ritz Carlton Reserve Luxury Villas, Bermuda  
Sheraton Maui Resort & Spa, Maui, HI  
Hillcrest Country Club, Beverly Hills, CA  
Geneva Inn, Lake Geneva, WI  
Fontainebleau Miami Beach, Miami Beach, FL  
The Irvine Company, Irvine, CA  
Greenwich Country Club, Greenwich, CT



203.626.5625 | [brownjordanoutdoorkitchens.com](http://brownjordanoutdoorkitchens.com)  
1 Grand Street, Wallingford, CT 06492

BROWN JORDAN is a registered trademark of Brown Jordan International, Inc. and is used under license to CT Acquisitions, LLC.